



OPTIBELT
TECHNICAL MANUAL
POLYURETHANE TIMING BELTS



Engineered
in Germany
Quality since 1872

**INCLUDING PULLEYS
AND BUSHES**



TECHNICAL MANUAL

POLYURETHANE

TIMING BELTS



The optibelt ALPHA timing belts consist of steel or aramid tensile reinforcements and polyurethane that e.g. exhibits an increased chemical resistance, compared to rubber, and can be welded as a thermoplastic material.

The endless ALPHA TORQUE / POWER of cast polyurethane and optibelt ALPHA FLEX timing belts enable a slip-free and synchronous power transmission of up to several hundred kilowatt.

For an exact positioning in linear drives, the open-ended optibelt ALPHA LINEAR timing belts are suitable. These and optibelt ALPHA FLEX timing belts are extruded and moulded from thermoplastic polyurethane.

Timing belts of thermoplastic polyurethane with finger-shaped ends can be welded to produce endless optibelt ALPHA V timing belts for use in transport drives.

Subsequently applied coatings or cleats can fulfil higher transport requirements. If required the base belt, the coating or the cleats, may be adjusted geometrically. For such modified belts, the designation, "SPECIAL" is added to their name. Thermoplastic base belts, pre-adjusted for transport tasks on the tooth and top surfaces, are especially economic. These are supplemented by small to medium axis distances with cast timing belts, adjusted on the top surface, such as the optibelt ALPHA SRP.

All important information as well as the methods to calculate drives with Optibelt timing belts of polyurethane are included in the present Technical Manual. They are supplemented by the Optibelt product spectrum of belts and pulleys, Technical Data Sheets about optibelt ALPHA timing belts, the optibelt CAP software for drive design, CAD drawings of pulleys, the cleat selector and additional Optibelt documentations for which up-to-date information is available on the Optibelt website.

If you have any further questions, the free service provided by our application engineers will be available to you.

OPTIBELT EUROPE

OPTIBELT AFRICA

OPTIBELT AMERICA

Optibelt's partners can be found in most countries throughout the world



Optibelt GmbH
www.optibelt.com



Optibelt Nederland B.V.
www.optibelt.nl



Optibelt GmbH
www.optibelt.be



Optibelt Österreich GmbH
www.optibelt.at



Optibelt Polska Sp. z o.o.
www.optibelt.pl



Optibelt Hungary Kft.
www.optibelt.hu



Optibelt (Canada) Inc.
www.optibelt.ca



Optibelt de México
www.optibelt.mx



Optibelt do Brasil Ltda.
www.optibelt-br.com



Optibelt Indonesia
www.optibelt.co.id



Optibelt Asia Pacific Pte. Ltd.
www.optibelt.sg



Optibelt Power Transmission (Shanghai) Co., Ltd.
www.optibelt.cn

OPTIBELT ASIA

OPTIBELT AUSTRALIA



Optibelt AG
www.optibelt.ch



Optibelt (UK) Ltd.
www.optibelt.co.uk



Optibelt France SAS
www.optibelt.fr



Optibelt AG
www.optibelt.it



Optibelt España, S.A.
www.optibelt.es



**Optibelt Güç Aktarma
Ekipmanları San.
Ve Tic. Ltd. Sti.**
www.optibelt.com.tr



**OOO „Optibelt
Power Transmission“**
www.optibelt.ru



Optibelt Finland Oy
www.optibelt.fi



Optibelt Skandinaviska AB
www.optibelt.se



Optibelt Corporation
www.optibelt.us



Optibelt Colombia S. A. S.
www.optibelt.com



**Optibelt
Power Transmission
India Pvt. Ltd.**
www.optibelt.in



**Optibelt
Australia Pty Ltd.**
www.optibelt.com.au



Optibelt TRANZ Corp.
www.optibelt.co.nz



Optibelt Philippines
www.optibelt.ph



Optibelt Thailand
www.optibelt.co.th



Optibelt Vietnam
www.optibelt.vn



	Introduction	1
	Distribution Organisation of the Arntz Optibelt Group	2
1	PRODUCT DESCRIPTION	
1.1	Drive Types and General Features	8
1.2	Production Processes and Features of the Base Belts	10
	Production process: Casting	10
	Production process: Extrusion	11
	Production process: Welding	12
	Overview of production processes and features	13
1.3	Structure, Coatings, Cleats and Profiles of the Base Belts	14
	Timing belt structure, single profile design	14
	Timing belt structure, teeth on both sides	14
	Profile variations, teeth on one side	15
	Coating variations as part of the base belt	16
	Cleats as integral part of the base belt	17
1.4	Profiles, Features, Dimensions and Standards	18
	Imperial profile	18
	T profile	18
	TK profile with notched V-guide	19
	AT profile	20
	ATK profile with notched V-guide	20
	ATL profile	21
	HTD profile	21
	F profile	21
	Standards	22
	Product groups, base profiles, profiles and cords	22
1.5	Tension Cord Materials and Designs, Pulley Tooth System	24
	Tension cord material: Steel in standard design, ST	24
	Tension cord material: Stainless steel, RF	24
	Tension cord material: Steel of highly flexible structure, HF	24
	Tension cord material: Aramid, AR	25
	Tension cord material: Polyester, PES	25
1.6	Mode of Action	25
	Tooth engagement and pitch, simplified determination	25
	Forces in the two-pulley power drive	27
2	BASICS OF DRIVE DESIGN	
2.1	Gear Drive Geometry, Important Parameters and Formulas	28
	Belt geometry, important parameters	28
	Pulley functions, terms and numbers of teeth	29
	General formulas for external loads, rated capacity and geometry	30
	Circumferential forces and movement types	31
	Linear and transport drives: Inclined conveyors and lifting drives	32
	Static belt tensions of loaded and relieved drives, recommended belt tension force	33
2.2	Drive Service Factors, Allowances and Formulas	36
	Total drive service factor c_2	36
	Base drive service factor c_0	37
	Pulley and idler allowance c_6 and start frequency allowance c_8	37
	Length factor c_3	37
2.3	Formula Symbols	38



3 POWER DRIVES

3.1 General	39
3.2 Variants	41
3.3 Basics for Drive Design	42
3.4 Timing Belt Pre-selection	42
Selection of tooth system	42
Maximum belt speeds	43
Pre-selection of profile and width	43
3.5 Drive Design	45
Requirement	45
Calculation methods	45
Total drive service factor c_2	45
Design power P_B	46
Selection of tooth system	46
Belt pre-selection of profile and width	46
Timing belt pulleys	46
Effective output speed and transmission	47
Effective length	47
Drive centre distance	48
Recommended drive centre distances and collision check	48
Timing belt and pulley width	49
Static belt tension and circumferential force	50
Static shaft loading	51
Order example	51
Belt tension adjustment through frequency measurement	51
Belt tension adjustment through measurement of the elongation	52
Allowances for tensioning and fitting	53
3.6 Technical Data Sheet	54

4 LINEAR DRIVES

4.1 General	55
4.2 Variations	57
Linear drive, fixed motor	57
Linear drive, moving motor	57
4.3 Timing Belt Pre-selection	58
Selection of tooth system	58
Pre-selection of profile and width	59
4.4 Basics for Drive Design	61
Accelerations, speeds, distances and times	61
4.5 Drive Design	63
Requirement	63
Calculation methods	63
Design circumferential force F_{BU} through the drive torque load M_N	63
Design circumferential force F_{BU} through acceleration and friction forces	64
Selection of tooth system	65
Belt pre-selection of profile and width	65
Calculation of the belt and pulley geometry	65
Rated tensile force	66
Static and maximum belt tension	67
Static shaft loading	68
Belt length and order designations	68
Belt tension adjustment through frequency measurement	68
Belt tension adjustment through measurement of the elongation	69
Allowances for tensioning and fitting	70
4.6 Repetition and Positioning Accuracy	72
4.7 Technical Data Sheet	76



5 TRANSPORT DRIVES

5.1 General	77
5.2 Variations	78
5.3 Timing Belt Pre-selection	79
Selection of tooth system	79
Pre-selection of profile and width	80
5.4 Basics for Drive Design	82
5.5 Drive Design	83
Requirement	83
Calculation methods	83
Calculation circumferential force F_{BU} through the drive normal torque M_N	83
Design circumferential force F_{BU} through friction forces	84
Selection of tooth system	85
Belt pre-selection of profile and width	85
Calculation of the belt and pulley geometry	86
Rated tensile force	87
Static and maximum belt tension	88
Static shaft loading	89
Belt length and order designations	89
Belt tension adjustment through frequency measurement	89
Belt tension adjustment through measurement of the elongation	90
Allowances for tensioning and fitting	91
5.6 Technical Data Sheet	93

6 COATINGS, CLEATS AND ADJUSTMENTS

6.1 Polyamide Fabric Coating	94
Polyamide fabric on the tooth system (PAZ)	94
Polyamide fabric on the top surface (PAR)	94
6.2 Subsequently Applied Coatings	96
Characteristics and design aids	96
Pre-selection for coatings of polyurethane (PU), rubber and polyvinyl chloride (PVC)	98
Coating material polyurethane (PU)	100
Coating material rubber	105
Coating material polyvinyl chloride (PVC)	109
Coatings for special requirements	114
Price index overview	116
6.3 Cast Coatings and Base Belts, optibelt ALPHA SRP, ALPHA TORQUE / ALPHA POWER	117
optibelt ALPHA TORQUE / POWER special designs	117
optibelt ALPHA SRP designs	117
Production process	117
Moulding, contours	118
Tolerances, surfaces	118



6 COATINGS, CLEATS AND ADJUSTMENTS

6.4 Subsequently Applied Cleats	119
Application examples	119
Cleat materials	120
Production of polyurethane cleats	122
Polyurethane cleat groups and non detachable fastening methods	125
Position in relation to tooth, number of teeth on pulley and fastening strength	130
Position and pitch tolerances	131
Belt length and cleat pitch	131
Screw-on cleats	132
Screw connection using a metal tooth	133
Overview of cleat fastening methods	133
6.5 Cast Cleats and Base Belts, optibelt ALPHA SRP	134
Production, casting process	134
Shapes and shaping	136
Design guidelines, position and dimension tolerances	137
6.6 Adjustment through Mechanical Processing	138
Transport drives with mechanically processed belts	138
Manufacturing processes	139

7 DESIGN AIDS, DIMENSIONS, TOLERANCES

7.1 Belt Tension: Measuring Methods and Adjustment	142
Conditions and instructions	142
Measuring methods, applications and measuring instruments	144
Belt tension adjustment through frequency measurement	144
Belt tension adjustment through measurement of the elongation	146
7.2 Shaft/Hub Connections	148
7.3 Design Aids	149
Timing belt pulleys	149
Timing belt pulley tolerances	149
Minimum diameter	150
Idlers	151
Flanges, lateral guide	152
Clamping plates	153
7.4 Belt Tolerances	154
Length measurement conditions	154
Length tolerances	155
Width tolerances	155
7.5 Allowances	155
7.6 Resistance against chemical influences	156
7.7 Influences during Operation, Installation and Maintenance, Storage and Transport	159
Safety instructions for operation	159
Influences of substances, chemicals and temperatures during operation	159
Installation of the drive	159
Timing belt sets	161
Maintenance and inspection	161
Storage and transport	162
General condition	162
Storage	162
Cleaning	162
7.8 Damage Patterns, Causes and Action	163

1 PRODUCT DESCRIPTION

1.1 DRIVE TYPES AND GENERAL FEATURES



1.1 Drive Types and General Features

The application range of the polyurethane timing belts covers power drives, linear drives and transport drives. For each of these applications, the timing belt product groups, described in the introduction, have been developed respectively, which partly supplement each other.

The assignments of the individual product groups to the drive types are indicated in Table 1.1.1. The product groups can be applied alternatively depending on the feature and requirements profile also in other fields of application.

Table 1.1.1: Drive types and applications

Power drives		Linear drives	Transport drives	
ALPHA TORQUE ALPHA POWER	ALPHA FLEX	ALPHA LINEAR	ALPHA V	ALPHA V SPECIAL ALPHA SRP
endless		open-ended	welded endless	welded endless endless
Application examples		Application examples	Application examples	
Machine tools Textile machines Printing machines Packaging machines Office equipment Medical appliances Robots Handling devices		Positioning devices Lifting drives Handling devices Door and gate drives Wash stations Plotters Packaging machines Portal robots	Parallel or synchronous conveyors Inclined conveyors Accumulating conveyors Vacuum conveyors Withdrawal facilities Separators or workpiece positioners	
alternatively		alternatively	alternatively	
ALPHA V¹		ALPHA TORQUE ALPHA POWER ALPHA FLEX	ALPHA TORQUE SPECIAL ALPHA POWER SPECIAL ALPHA FLEX SPECIAL	

¹ For example, in exceptional cases a quickly available optibelt ALPHA V, if required, can replace a more powerful optibelt ALPHA FLEX to cover downtimes.

1 PRODUCT DESCRIPTION

1.1 DRIVE TYPES AND GENERAL FEATURES



Since the introduction of the first timing belt in the mid 40s, this drive element has continuously gained importance for synchronous force, torque and power transmission. The slip-free timing belt has proven successful in many applications and enabled economic solutions in all fields of mechanical engineering.

Today's significance of timing belts is attributable to, among other factors, continuously improved tooth profiles and belt designs. One result of this progress is the Optibelt timing belt and double profile timing belt made of polyurethane. The material-specific features of polyurethane lead to the following benefits:

- High abrasive resistance
- Good to very good resistance to oils, greases and a number of aggressive chemicals, partly EU food compliance / FDA
- Non staining
- Very good welding capability of thermoplastic polyurethanes
- High tooth shear strength
- Wide operating temperature range from -30 °C to $+80\text{ °C}$, is possible.
Other thermoplastic polyurethane designs more particularly suited to the temperature ranges of -30 °C to -20 °C or $+60\text{ °C}$ to $+80\text{ °C}$ are available on request.
- High electrical insulation capability of polyurethane in conjunction with aramid tensile reinforcement
- Good ageing resistance
- High ozone and UV resistance

In addition, all typical benefits of a drive with form-fit timing belts in a technical standard design can also be brought to bear for polyurethane timing belts:

- Synchronous speed transmission, high angular and positioning accuracy through low-stretch tensile reinforcements and form fit, further optimised in the ALPHA tooth profiles AT or ATL
- Counter-rotating synchronous operation for multi-pulley drive through double profile teeth
- Large speed ratio and small space due to high flexibility
- High circumferential speed due to low weight
- Maintenance-free due to extremely low-stretch steel tensile reinforcement, also applicable to a limited extent for aramid cord
- High efficiency due to slip-free design and high flexibility
- Cost-efficient bearing dimensioning due to low belt tension

The Optibelt polyurethane timing belt is consequently suitable, in addition to the synchronous standard operation, as an economic solution within the indicated functional benefits of the base material polyurethane.

1 PRODUCT DESCRIPTION

1.2 PRODUCTION PROCESSES AND FEATURES OF THE BASE BELTS



1.2 Production Processes and Features of the Base Belts

Optibelt timing belts

- ALPHA TORQUE, ALPHA POWER and ALPHA SRP of cast polyurethane or
 - ALPHA FLEX, ALPHA LINEAR and ALPHA V of thermoplastic polyurethane
- are basically also abrasion-resistant and shear-resistant. In addition, they feature an above-average resistance to chemicals and e.g. oils and greases and are highly ageing-resistant due to their resistance to ozone and UV light. Moreover thermoplastic polyurethane exhibits the benefit of welding capability as opposed to cast polyurethane.

The production processes

- Casting,
 - Extrusion and
 - Optional welding,
- assigned to product groups, are explained below.

The potential adjustment of base belts to transport tasks with the required production processes is described in Chapter 6 "Coatings, Cleats and Adjustments".

Production process: Casting

optibelt ALPHA TORQUE, ALPHA POWER and ALPHA SRP timing belts

Endless optibelt ALPHA TORQUE, ALPHA POWER and ALPHA SRP timing belts are manufactured from cast polyurethane and, in most cases, a tensile reinforcement in cylindrical cast moulds. Prior to the casting of the timing belt sleeve, usually a high-strength, flexible steel tensile reinforcement is helically wound around the interior mould core, see Fig. 1.2.1. The tensile reinforcement lies on the narrow production noses so that this takes on a defined position in the timing belt. The cast polyurethane is cast between the mould core and the cylindrical exterior mould. In the case of a double profile tooth system or the optibelt ALPHA SRP timing belt with cleats or a coating, the exterior shape is adjusted in terms of dimensions and geometry, see also Chapters 6.3 and 6.5. The timing belts are cut to width from the produced demoulded sleeve. The uncut steel tensile reinforcements protruding at the sides are separated manually so that the two ends lie in the frame without protruding at the sides. In the web region between the teeth, a small sleeve nose remains visible.

The polyamide fabric widely used for extruded timing belts cannot be integrated if casting is used as production process. This is only subsequently possible on the belt back. Subsequent welding of a cleat directly on the belt top surface is not possible with the cast polyurethane. Cast polyurethane does not have an EU food compliance / FDA approval for food contact.

Endless, cast polyurethane timing belts have the following features:

- High pitch precision
- optibelt ALPHA POWER with a 30 % higher performance
- Useful sleeve widths of up to 380 mm
- Belt lengths up to 2250 mm
- Fine contouring of e.g. cast cleats
- Free colour selection from two sleeves
- Cast double profile design
- Position of the tolerance field slightly variable, e.g. for firm axis distances
- No direct welding of cleats
- No optional polyamide fabric on tooth and top surfaces
- Polyamide fabric only subsequently on the top surface
- No EU food compliance / FDA

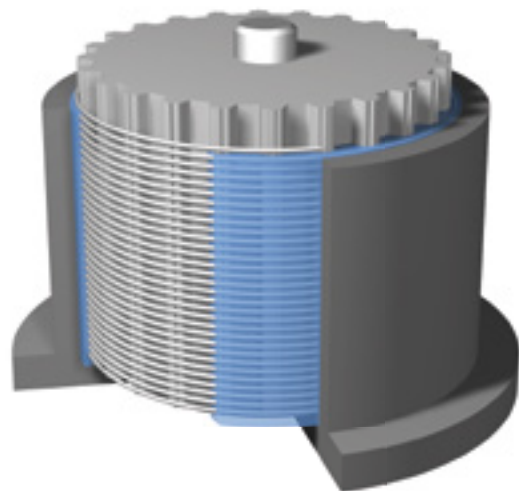

Figure 1.2.1: Moulding in a casting process with helically wound tensile reinforcement

1 PRODUCT DESCRIPTION

1.2 PRODUCTION PROCESSES AND FEATURES OF THE BASE BELTS



Production process: Extrusion

For the extruded timing belts optibelt ALPHA FLEX and ALPHA LINEAR, thermoplastic polyurethane is used which, due to its increased hardness, may exhibit a slightly smaller deformation compared to the standard cast polyurethane. Thermoplastic polyurethane can be welded as opposed to cast polyurethane.

On request, optibelt ALPHA LINEAR timing belts, and ALPHA V timing belts welded together from these, can be provided on the tooth side and the top surface with a polyamide fabric layer. On the tooth side this is also possible for optibelt ALPHA FLEX endless timing belts.

optibelt ALPHA FLEX timing belts

Endless optibelt ALPHA FLEX timing belts are produced according to the customer's length specification in an extrusion process of thermoplastic polyurethane without interrupting the tensile reinforcement.

Prior to the moulding process, two steel tensile reinforcements are wound on the production noses of two moulding wheels so that these have a defined position in the timing belt. After that, the thermoplastic polyurethane is extruded and moulded, see Fig. 1.2.2. Moulding occurs additionally through simultaneously running outer rolls or a steel strip which are not shown on Fig. 1.2.2. For a reinforced back, the extruded polyurethane amount is increased and the position of the outer rollers or the steel strip is adjusted. After cooling, the top surface is completely reground due to the material accumulation at the joint. In the web area between the teeth, a sleeve nose remains visible as in the casting process.

From the produced sleeve, the timing belts are cut to width. The uncut steel tensile reinforcements protruding at the sides are separated manually so that the two ends lie in the frame without protruding at the sides.

Top surface tooth systems of a double toothed belt are integrated step by step mechanically in a reinforced top surface. No sleeve nose occurs.

Endless extruded polyurethane timing belts have the following features:

- Lengths in separation stages of approx. 1 100 to 22 000 mm
- Fabrication widths 100 mm, 115 mm or 150 mm
- Double winding with one S+Z cord
- Double profile design available
- PAZ, polyamide fabric possible on tooth system
- Polyamide fabric only subsequently on the top surface
- Direct welding of cleats and V-guides
- For profiles T10, AT10, AT20 and 8M available as standard, PU analogue with EU food conformity / FDA

optibelt ALPHA LINEAR timing belts

Open-ended optibelt ALPHA LINEAR timing belts consist of extruded thermoplastic polyurethane and steel or aramid tensile reinforcements parallel to the edges.

In contrast to the optibelt ALPHA FLEX timing belt, single tensile reinforcements are laid step by step on a moulding wheel in parallel to the subsequent belt edges prior to the moulding process. After that, the thermoplastic polyurethane is extruded and moulded, see Fig. 1.2.3. Moulding occurs additionally through a simultaneously running steel strip which is not shown on Fig. 1.2.3. For a reinforced top surface, the extruded polyurethane amount is increased and the position of the steel strip is changed. The top surface of the belt is not ground. As opposed to the optibelt ALPHA FLEX, polyamide fabric cannot only run in on the tooth side, but also on the top surface.

Depending on the width, the belts are cut to width in the zones without tensile reinforcement and wound on 50 m or 100 m rolls after the cooling process.

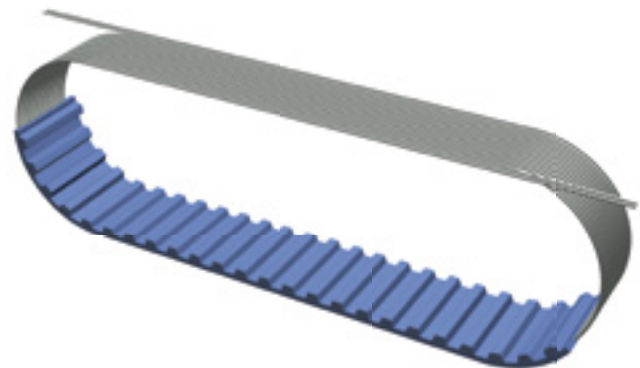

Figure 1.2.2: Extruded and moulded polyurethane with helically wound tensile reinforcements

1 PRODUCT DESCRIPTION

1.2 PRODUCTION PROCESSES AND FEATURES OF THE BASE BELTS



In an additional subsequent extrusion process, transparent polyurethane of the hardness 85 Shore A with the designation T2 or PU-Smart and further materials and designs such as PVC foil can be directly applied to the belt as an alternative to the design with a reinforced top surface.

As in the previous processes, the tensile reinforcements rest on narrow production noses so that the cord layer is defined in the belt. For applications e.g. in the food industry or in the wet area of washing lines, a continuous web without a sleeve nose can be manufactured to cover the cords on a special moulding wheel for the T10 profile.

Open-ended, extruded polyurethane timing belts have the following features:

- High tensile forces with low elongation
- High positioning accuracy
- S+Z tensile reinforcements parallel to the edges
- Base belt without sleeve nose in profile T10
- Also as flat belt in the F profile
- PAZ/PAR, polyamide fabric possible on tooth side and top surface
- Optional PU with EU Declaration of Compliance / FDA, see www.optibelt.com
- Designs such as reinforced top surface, T2, PU-Smart and others available
- Roll length 50 m or 100 m

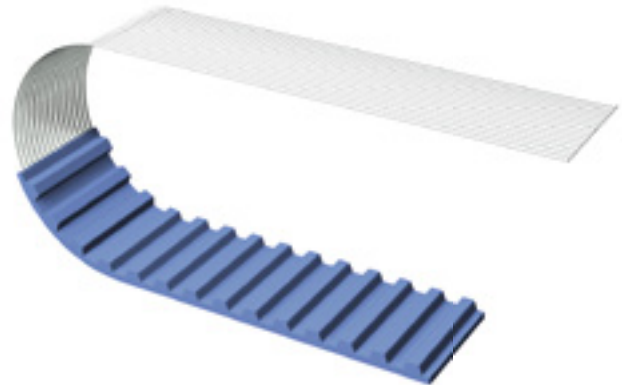

Figure 1.2.3: Extruded and moulded polyurethane with tensile reinforcements parallel to the edges

Production process: Welding

optibelt ALPHA V timing belts

Thermoplastic polyurethane timing belts optibelt ALPHA V are produced by endlessly welding open-ended, extruded optibelt ALPHA LINEAR timing belts.

As shown in Fig. 1.2.4, the two belt ends of the optibelt ALPHA LINEAR are, prior to welding, punched out in the shape of a finger or cut by a water jet in the shape of a finger. The belt ends are laid in a smooth and a toothed mould, depending on profile and width. Under pressure and temperature, the belt ends are welded together in the mould. Once the thermoplastic polyurethane has spread, the mould is cooled and the endlessly connected optibelt ALPHA V is withdrawn.

Due to the high strength of the thermoplastic polyurethane, welded timing belts exhibit, despite the interrupted tensile reinforcement, a permissible connection tensile force in the finger-shaped connection point, which reaches at least 50 % of the permissible tensile reinforcement of a belt with uninterrupted cords.

The PU coatings of the base belt designs reinforced top surface, T2, PU-Smart and APL plus are welded in conjunction with the base belt joint-free.

Open-ended, cast polyurethane timing belts have the following features:

- Minimum lengths depending on profiles and widths as of 400 mm
- Also very large lengths producible in partition stages
- Can be delivered on a short-term basis
- Ideal for transport drives
- PAZ/PAR, polyamide fabric possible on tooth side and top surface
- Optional PU EU food compliant / FDA
- Designs reinforced top surface, T2, PU-Smart and APL plus weldable when used together
- Direct welding of cleats and V-guides
- Without sleeve nose, profile-dependent in profile T10
- Also available as welded flat belt in the F profile



Figure 1.2.4: Punched out belt ends in finger shape and welded ALPHA V timing belt

1 PRODUCT DESCRIPTION

1.2 PRODUCTION PROCESSES AND FEATURES OF THE BASE BELTS



Overview of production processes and features

Table 1.2.1: Production processes, material, hardness, colour, product groups, lengths, polyamide fabric

Production process Material	Casting Cast polyurethane	Extrusion Thermoplastic polyurethane		
Standard hardness	84 Shore A 86 Shore A	92 Shore A		
Standard colour	transparent ¹ grey ¹	white		
PU (FDA): hardness, colour	–	85 Shore A, blue, optional transparent, ALPHA LINEAR: with EU Declaration of Compliance / FDA, see www.optibelt.com		
Special hardness	60-95 Shore A	85, 98 Shore A		
Special colour	on request according to RAL No.	e. g. black, blue or on request according to RAL No.		
Minimum quantity for special hardness, colour	two sleeves	from 200 m with maximum production width		
Product group	ALPHA TORQUE ALPHA POWER ALPHA SRP endless	ALPHA FLEX endless	ALPHA LINEAR open-ended	ALPHA V welded endless
Minimum length	Length ranges, partly depending on profile, width			
Non standard lengths	53 mm ² , 60.96 mm ³	1100 mm, with PAZ from 1500 mm	in indexing steps	400 -1000 mm for self-tracking timing belts ⁴
Largest length	see product range 900 mm ⁵ , 2250 mm	in indexing steps 22 000 mm	in indexing steps 50 m, 100 m rolls, longer ⁶	in indexing steps weldable in any arrangement
Load bearing capacity	Drive design			
Number of teeth in gear ⁸	100 %, 130 % ⁷	100 %	100 %	50 %
	12	12	12	6
	Base belt optionally with polyamide fabric: PAZ / PAR			
on tooth system, PAZ ⁹	–	+	+	+
on top surface, PAR	–	–	+	+

¹ optibelt ALPHA TORQUE, 84 Shore A, transparent; optibelt ALPHA POWER, 86 Shore A, grey; ± 4 Shore A each

² For example splined optibelt ALPHA POWER timing belt, pitch 1.5 mm, e. g. for car mirror adjustment

³ Profile MXL, pitch 2.032 mm; profile T5 from 120 mm

⁴ Minimum length: depending on profile and width, see Technical Data Sheets

⁵ optibelt SRP in SpinCast; optibelt ALPHA TORQUE, ALPHA POWER, ALPHA SRP up to 2250 mm

⁶ Roll length bigger than 100 m on request; limited by roll handling

⁷ optibelt ALPHA TORQUE 100 %; optibelt ALPHA POWER 130 %; optibelt ALPHA SRP 100 % or 130 %

⁸ Maximum calculated number of teeth

⁹ Double profile optibelt ALPHA LINEAR / V with PA fabric on one side only

1 PRODUCT DESCRIPTION

1.3 STRUCTURE, COATINGS, CLEATS AND PROFILES OF THE BASE BELTS



1.3 Structure, Coatings, Cleats and Profiles of the Base Belts

Timing belt structure, single profile design

Top surface

The belt top surface of polyurethane has to accommodate and support the tension cords on the top surface. The abrasion-resistant, thin and therefore flexible top layer also protects the tension cords against exterior influences and wear e.g. by a top surface roller running simultaneously.

Tension cords

The tension cord of the endless optibelt ALPHA TORQUE, ALPHA POWER, ALPHA SRP and ALPHA FLEX timing belts consists of a steel cord that runs helically in the belt. The top surface together with the teeth and webs are one unit so that the tension cord is embedded in polyurethane.

Due to the small cross profile and the design of the tension cord, it is highly flexible. Despite this, it is highly stretch-resistant due to its high specific tensile strength.

In contrast to this, the open-ended optibelt ALPHA LINEAR bulk stock exhibits steel cords or aramid tension cords in parallel to the edges. This applies also to the endless welded optibelt ALPHA V timing belts.

Teeth and webs

The belt teeth of polyurethane serve for the force transmission between the tension cord and the tooth flank of the timing belt pulleys, whereas the polyurethane webs, depending on the profile, support the tension cords against the tooth crests of the pulley, see e.g. T profile in Fig. 1.6.1.

The shear-resistant and strong teeth are formed and arranged in such a way that they gear into the tooth spaces of the pertaining pulley. If, for the optibelt ALPHA V timing belt six teeth or for the optibelt ALPHA TORQUE, ALPHA POWER, ALPHA SRP, ALPHA FLEX and ALPHA LINEAR timing belt twelve teeth and more are in gear on the small pulley, the maximum permissible circumferential force of the timing belt can be fully transmitted.

Timing belt structure, teeth on both sides

The double profile timing belt is used for speed reversal in power drives. The structure of the double profile timing belt is basically similar to that of the described single tooth belt. In the T profile, the tooth system is arranged on the upper and lower side offset to each other and with an identical pitch, see Figure 1.3.2. In the AT and HTD profiles, the tooth system is arranged opposite to each other so that in this case the flexibility of the single profile belt is retained.

The type of the tension cord and its location to the web and tooth in the belt are not distinguished between the two designs. The permissible overall power of the double profile timing belt is not doubled, but corresponds to that of the single profile timing belt. The transmitted power can be freely distributed on both tooth sides depending on the number of teeth in gear on the driven side.

The different profiles, features, dimensions and standards are described in Chapter 1.4.

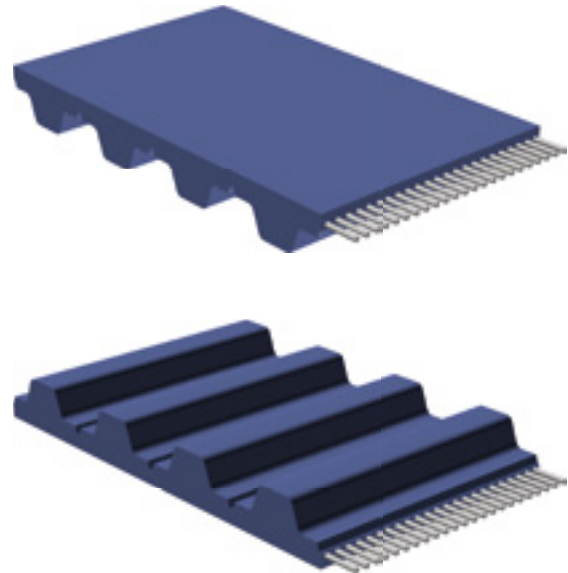

Figure 1.3.1: Polyurethane timing belt, single profile

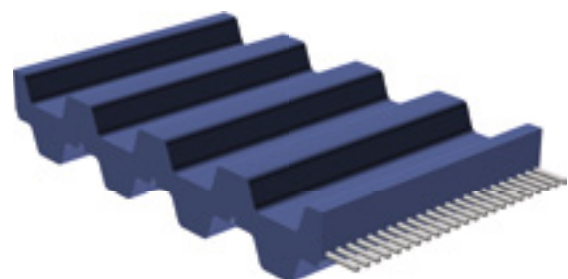

Figure 1.3.2: Polyurethane timing belt, teeth on both sides

1 PRODUCT DESCRIPTION

1.3 STRUCTURE, COATINGS, CLEATS AND PROFILES OF THE BASE BELTS



Profile variations, teeth on one side

Track timing belts with notched V-ledge

The side guidance of an optibelt ALPHA V conveyor belt can be achieved by a notched V-ledge on the tooth side as an alternative to flanges and U-shaped support rails. Track timing belts require correspondingly adjusted timing belt pulleys and support rails with keyway. A subsequent grooving and welding-in of a full-profile V-ledge – which is not notched – is not necessary. For this reason, optibelt ALPHA V track timing belts with a central notched V-guide and a standard 100 mm width can be offered at a comparatively lower price than timing belts with a subsequently welded V-guide.

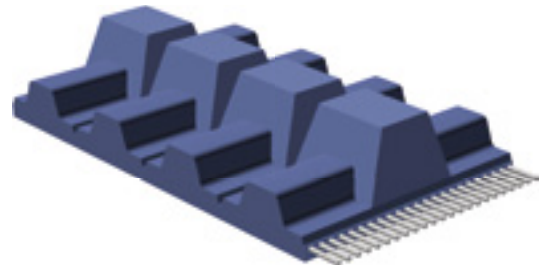

Figure 1.3.3: Polyurethane track timing belt with moulded V-ledge

1 PRODUCT DESCRIPTION

1.3 STRUCTURE, COATINGS, CLEATS AND PROFILES OF THE BASE BELTS



Coating variations as part of the base belt

Polyamide fabric PAZ, PAR, PAZ / PAR

Polyamide (PA) fabric serves for the friction and noise minimisation in the case of thermoplastic timing belts optibelt ALPHA LINEAR / V and optibelt ALPHA FLEX.

As part of the timing belt, the polyamide fabric in these product groups can run in as well during the moulding on the teeth of the shaping wheel. Green polyamide fabric is shown on Figure 1.3.4 on the teeth. This design is called PAZ.

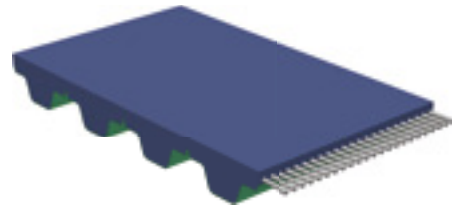
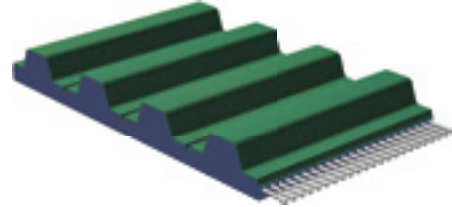

Figure 1.3.4: Polyamide fabric on the tooth system, PAZ

In Figure 1.3.5, green polyamide fabric is shown on the smooth top surface – called PAR – of an optibelt ALPHA LINEAR timing belt. This polyamide fabric also runs in during the moulding process, however, here on the top surface.

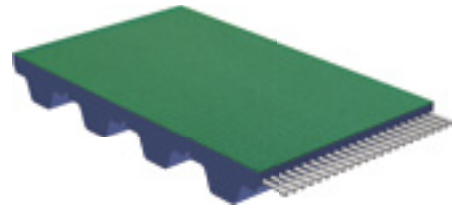

Figure 1.3.5: Polyamide fabric on the top surface, PAR

Accordingly, the optibelt ALPHA LINEAR / V timing belts can also be manufactured with polyamide fabric on both sides – abbreviation PAZ / PAR – see Figure 1.3.6.

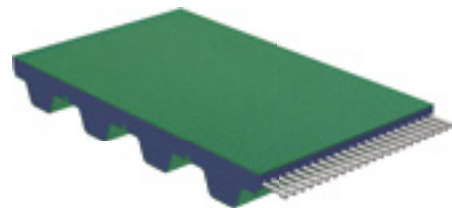

Figure 1.3.6: Polyamide fabric on the tooth system and on the top surface, PAZ / PAR

The smooth top surface of an optibelt ALPHA FLEX cannot be equipped with polyamide fabric during production. This generally applies also to teeth on the top surface. Double profile, thermoplastic timing belts can be delivered as shown in Figure 1.3.7 only in the PAZ design.

The polyamide fabric is addressed in detail in Chapter 6.1.

Table 1.2.1 shows an overview of the production possibilities of polyamide fabric as an integral part of the base belt depending on the product groups.

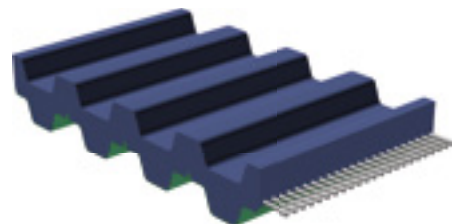

Figure 1.3.7: Polyamide fabric on one toothed side of a double toothed belt

1 PRODUCT DESCRIPTION

1.3 STRUCTURE, COATINGS, CLEATS AND PROFILES OF THE BASE BELTS



Reinforced top surface

For conveying purposes, optibelt ALPHA V, ALPHA FLEX and ALPHA SRP can be directly produced with a reinforced top surface of polyurethane, see Figure 1.3.8. This is the simplest and hence the most cost-efficient variation among the coated belt designs of the thermoplastic polyurethane timing belts.

In the case of the cast optibelt ALPHA SRP, which is described in Chapter 6.3, the reinforced polyurethane top surface can also have hardnesses that differ from the hardness of the base belt.

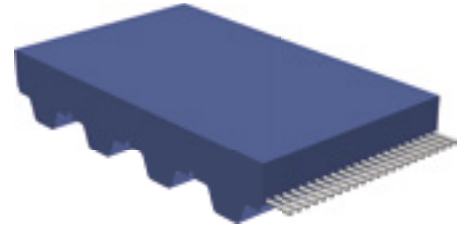

Figure 1.3.8: Polyurethane timing belt of the reinforced top surface design

T2, PU-Smart and APL plus

Open-ended optibelt ALPHA LINEAR timing belts can be equipped on the top surface during production directly with the

- smooth polyurethane coating T2, see Figure 1.3.9 or the
- profiled PU coating, longitudinal groove fine, see Figure in Subchapter 6.2,
- foamed coating PU-Smart, see Figure 1.3.10,
- smooth polyvinyl chloride coating APL plus, see Figure 5.2.5,

and further materials and designs and welded together with the coating to an endless optibelt ALPHA V.

Subsequent coating is hence not necessary. As a result, these belt designs can generally be offered at a lower price than subsequently coated ALPHA V SPECIAL timing belts.

The coatings mentioned here and the large number of subsequently applied coatings for any base belt group beyond polyurethane timing belts are described in Chapter 6.2.

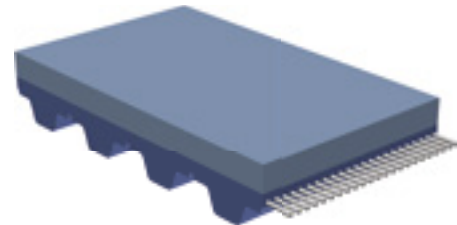

Figure 1.3.9: Polyurethane timing belt with T2 coating

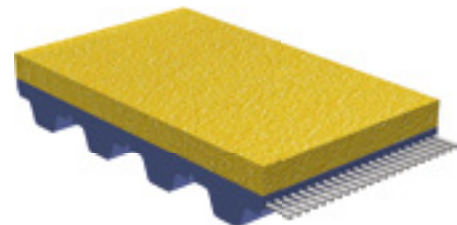

Figure 1.3.10: Polyurethane timing belt with coating PU-Smart

Cleats as integral part of the base belt

In the same way as the tooth design on the top surface of double profile, cast ALPHA TORQUE timing belts and ALPHA POWER, individually designed cleats can be moulded together with the belt teeth on the top surface in the case of the optibelt ALPHA SRP. The Figure 1.3.11 shows the example of a possible cleat design.

In the case of the optibelt ALPHA SRP, the polyurethane cleat can alternatively also be manufactured in hardnesses that differ from the hardness of the base belt. Further details are given in Chapter 6.5.

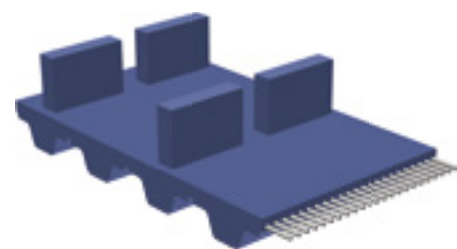

Figure 1.3.11: Polyurethane timing belt with cleats of polyurethane

1 PRODUCT DESCRIPTION

1.4 PROFILES, FEATURES, DIMENSIONS AND STANDARDS



1.4 Profiles, Features, Dimensions and Standards

The first timing belts had a trapezoidal shape with imperial pitch and were designed for synchronous power drives. The trapezoidal shape is likewise suitable for conveyor drives with a support rail which the flat tooth head can rest on. This does not only apply to round profiles with a too small contact area on the support rail. The improved round HTD profile is especially suitable for power drives and linear drives thanks to its higher skip protection and reduced operating noise. Nevertheless, the further developed trapezoidal AT profile is to be preferred for linear drives of high requirements for the positioning accuracy – especially due to the reduced backlash between belt and pulley.

For reversing the sense of rotation, double profile timing belts are possible in addition to single profile timing belts. Like the single profile timing belts, they exhibit a sleeve nose generally on one side only. The top tooth widths given in the following table may differ slightly depending on the product group, and profile.

Imperial profile

Today, the imperial, trapezoidal profile is hardly used any more in new designs, particularly in the European area. An exemption is e.g. the H pitch as a standby solution for transport chains. Optibelt polyurethane timing belts with an imperial pitch replace chloroprene timing belts with the same pitch where the requirements for chemical resistance are high.

Table 1.4.1: Dimensions of imperial profile

Profile	Pitch	Overall height	Tooth height	Tooth width	Flank angle
	t [mm]	h [mm]	h_t [mm]	s [mm]	β [°]
MXL	2.032	1.14	0.51	0.77	40
XL	5.080	2.30	1.27	1.39	50
L	9.525	3.60	1.91	3.26	40
H	12.700	4.30	2.29	4.45	40
XH	22.225	11.20	6.35	7.95	40

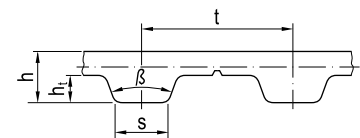

Figure 1.4.1: Imperial profile

Bottom tooth width [mm]: MXL: 1.14; XL: 2.57; L: 4.65; H: 6.12; XH: 12.57

T profile

The most common metric T profile has a trapezoidal shape as the imperial profile. In new designs, this profile is selected for drives that are specifically exposed to low loads. Due to the thinner tension cord diameters and the smaller teeth compared to the AT and HTD profiles, the belt is more flexible and can be used on smaller timing belt pulley diameters.

The backlash and the belt elongation under load are bigger than at the AT timing belt of the same pitch. The belt web between the teeth rests on the tooth heads of the pulley tooth system. In e.g. strongly dust-loaded environments, the larger backlash or the larger clearance between belt and pulley can minimize the tendency to build up accumulations as opposed to the AT profile.

1 PRODUCT DESCRIPTION

1.4 PROFILES, FEATURES, DIMENSIONS AND STANDARDS



Table 1.4.2: Dimensions of T profile

Profile	Pitch	Overall height	Tooth height	Tooth width	Flank angle
	t [mm]	h [mm]	h_t [mm]	s [mm]	β [°]
T2.5	2.5	1.3	0.7	0.99	40
T5	5.0	2.2	1.2	1.78	40
T10	10.0	4.5	2.5	3.48	40
T20	20.0	8.0	5.0	6.51	40

Bottom tooth width [mm]: T2.5: 1.50; T5: 2.65; T10: 5.30; T20: 10.15

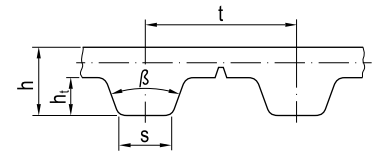

Figure 1.4.2: T profile

Table 1.4.3: Dimensions of DT profile, double profile

Profile	Pitch	Overall height	Tooth height	Tooth width	Flank angle
	t [mm]	h [mm]	h_t [mm]	s [mm]	β [°]
DT5	5.0	3.4	1.2	1.78	40
DT10	10.0	7.0	2.5	3.48	40
DT20	20.0	13.0	5.0	6.51	40

Bottom tooth width [mm]: see table 1.4.2

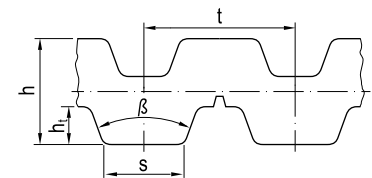

Figure 1.4.3: DT profile

TK profile with notched V-guide

The described T profile is produced with the pitches of 5 mm and 10 mm for transport drives, alternatively also with a V-guide in the TK profile. The central V-guide provides a lateral guidance of the conveyor timing belt in the groove of the timing belt pulley and the support rail. To achieve a reduced minimum pulley diameter as opposed to track timing belts with full-profile wedge, the V-guide is notched.

In applications with e.g. eccentric guide groove, a full-profile V-guide can be welded subsequently into an accordingly longitudinally grooved tooth system.

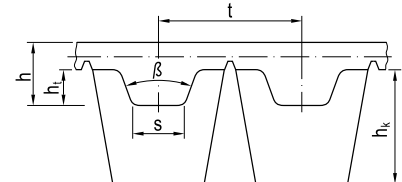

Figure 1.4.4: TK profile with notched V-guide viewed from the side

Table 1.4.4: Dimensions of TK profile

Profile	Profile dimensions	Wedge width	Wedge height	Wedge angle
	see	b_k [mm]	h_k [mm]	β_k [°]
T5K6	T5	6	4	38
T10K6	T10	6	4	38
T10K13	T10	13	6.5	38

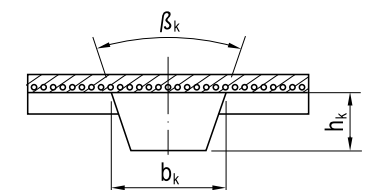

Figure 1.4.5: TK profile with notched V-guide in cross profile

1 PRODUCT DESCRIPTION

1.4 PROFILES, FEATURES, DIMENSIONS AND STANDARDS



AT profile

The AT profile was developed on the basis of the proven trapezoidal T profile and is generally preferred in new designs not only for power drives. The designation AT stands for advanced T profile.

The AT timing belt has the biggest tooth widths and hence the highest tooth shear resistance or the highest permissible specific tooth force of all trapezoidal profiles. Due to the low tooth deformation of the AT profile, the comparably strong cords and the comparably low backlash, high positioning accuracies under load are achieved in linear drives.

In contrast to the other trapezoidal profiles, the AT tooth rests on the tooth head area in the tooth gaps of the tooth system of the pulleys. A further benefit of the large tooth head of the AT tooth system is the low tooth wear or the higher load bearing capacity of the tooth in conveyor drives due to the reduced surface pressure between belt and supporting rail.

Table 1.4.5: Dimensions of AT profile

Profile	Pitch	Overall height	Tooth height	Tooth width	Flank angle
	t [mm]	h [mm]	h_t [mm]	s [mm]	β [°]
AT5	5.0	2.7	1.2	2.5	50
AT10	10.0	4,5*	2.5	5.0	50
AT20	20.0	8.0	5.0	10.0	50

Bottom tooth width [mm]: AT5: 3.62; AT10: 7.33; AT20: 14.66

* For ALPHA TORQUE and ALPHA POWER timing belts: 5.0 mm

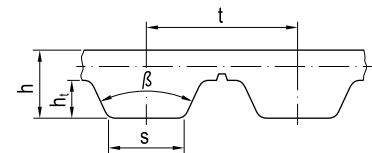

Figure 1.4.6: AT profile

ATK profile with notched V-guide

The described AT profile is produced in the pitches 5 mm and 10 mm for transport drives alternatively also with a V-guide in the ATK profile. The central V-guide provides a lateral guidance of the conveyor timing belt in the groove of the timing belt pulley and the support rail. To achieve a reduced minimum pulley diameter as opposed to track timing belts with full-profile wedge, the V-guide is notched.

In applications with belt widths of 75 mm and a smaller and/or e.g. eccentric guide groove, and with a belt width of 100 mm, a full-profile V-guide can be welded subsequently into a corresponding longitudinally grooved tooth system.

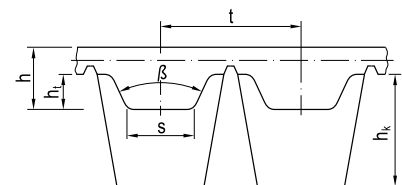

Figure 1.4.7: ATK profile with notched V-guide viewed from the side

Table 1.4.6: Dimensions of ATK profile

Profile	Profile dimensions	Wedge width	Wedge height	Wedge angle
	see	b_k [mm]	h_k [mm]	β_k [°]
AT5K6	AT5	6	4	38
AT10K6	AT10	6	4	38
AT10K13	AT10	13	6.5	38

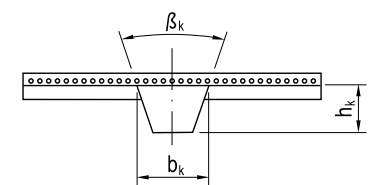

Figure 1.4.8: ATK profile with notched V-guide in cross profile

1 PRODUCT DESCRIPTION

1.4 PROFILES, FEATURES, DIMENSIONS AND STANDARDS



ATL profile

For a more accurate positioning in the linear technology, reinforced tension cords which are more flexible due to an increased cord diameter are included in belts with ATL profile. The specific shapes of the ATL profile with a reduced height of the production nose enable an identical position of the tension cord centre of the reinforced cords as opposed to the AT profiles and, as a result, their use in AT pulleys. Consequently, no deviating, in the effective diameter adjusted special timing belt pulleys are required.

In addition, the belts are produced to balance the higher pre-tension in a slight negative tolerance. The data indicated to the AT profile apply accordingly, see Table 1.4.5.

HTD profile

The HTD profile is a round curved profile that features a smoother run in comparison to the trapezoidal tooth and a higher skip protection due to the larger tooth height. The profile designation stands for "high torque drive". It was developed for the highly loaded drives in today's new designs primarily used in power drives which cannot be equipped with chloroprene timing belts in the HTD or OMEGA profile e.g. due to chemical loads. The HTD profile has a large tooth width at the tooth basis and features therefore a high tooth shear resistance and a high permissible specific tooth force. In addition, timing belts with HTD profile are applied, despite the slightly increased tooth clearance for power drives, in linear drives of increased requirements regarding the running noise. The belt webs between the teeth rest on the tooth heads of the tooth system of the pulleys. Double profile timing belts in the D5M and D8M profiles are available depending on the product group.

Due to the round tooth shape and the very small contact area, a high surface pressure is produced at the contact with a support rail in transport applications. As a result, for conveyor drives with a high transport load, the HTD profile cannot be recommended, due to the unfavourable wear behaviour at the tooth head.

Table 1.4.7: Dimensions of HTD profile

Profile	Pitch	Overall height	Tooth height	Tooth width	Flank angle
	t [mm]	h [mm]	h_t [mm]	s [mm]	β [°]
5M	5.0	3.6	2.06	—	—
8M	8.0	5.6	3.38	—	—
S8M	8.0	5.3	3.05	—	—
14M/ML	14.0	10.0	6.00	—	—

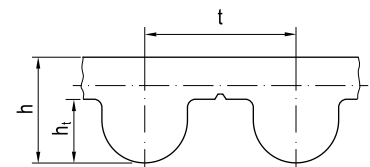

Figure 1.4.9: HTD profile

F profile

The F profile is a flat belt profile that is used on cylindrical shapes with production noses with a pitch of 10 mm similar to the timing belts.

Table 1.4.8: Dimensions of F profile

Profile	Pitch	Overall height	Tooth height	Tooth width	Flank angle
	t [mm]	h [mm]	h_t [mm]	s [mm]	β [°]
F2	—	2	—	—	—
F2.5	—	2.5	—	—	—
F3, FL3	—	3	—	—	—

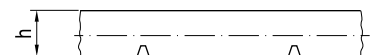

Figure 1.4.10: F profile

1 PRODUCT DESCRIPTION

1.4 PROFILES, FEATURES, DIMENSIONS AND STANDARDS



Standards

Table 1.4.9: Standards

Standard	AT profile	T profile	Imperial profile	HTD profile
Timing belt standard	ISO 17396	ISO 17396	DIN ISO 5296 Part 1	ISO 13050
Timing belt pulley standard	ISO 17396	ISO 17396	DIN ISO 5294	ISO 13050

Product groups, base profiles, profiles and cords

Table 1.4.10 provides an overview of the product groups with the pertaining profiles together with the superordinated base profiles and cords.

In the product group optibelt ALPHA TORQUE, ALPHA POWER and ALPHA SRP, further pitches of the T and AT profiles such as e.g. T2, T20, AT3, AT20 or the notched timing profiles TR10, TR15 with the pitches 1.0 mm and 1.5 mm can be delivered on request.

1 PRODUCT DESCRIPTION

1.4 PROFILES, FEATURES, DIMENSIONS AND STANDARDS



Table 1.4.10: Product groups, base profiles, profiles and cords

	Product groups			
	ALPHA TORQUE ALPHA POWER ALPHA SRP cast, endless	ALPHA FLEX extruded, endless	ALPHA LINEAR extruded, open-ended	ALPHA V welded, endless
Base profiles	Profiles			
Imperial profile	MXL, XL, L (ALPHA TORQUE)	H	XL, L, H, XH	L, H, XH
T profile	T2.5, T5, T10, DT5, DT10	T5, T10, T20, DT5, DT10	T5, T10, T20 T10 groove-free	T5, T10, T20, TT5, DT5 ¹ , DT10 ¹
TK profile, V-guide				T5K6, T10K6, T10K13
AT profile	AT5, AT10	AT5, AT10, AT20, DAT5, DAT10	AT5, AT10, AT20	AT5, AT10, AT20, DAT5 ¹ , DAT10 ¹
ATK profile, V-guide				AT5K6, AT10K6, AT10K13
ATL profile			ATL5, ATL10, ATL20	
HTD profile S8M		5M, 8M, 14M, D5M, D8M	5M, 8M, S8M, 14M, 14ML, 14 MLP	5M, 8M, 14M, D5M ¹ , D8M ¹
F profile, flat belts			F2, F2.5, F3, FL3	F2, F2.5, F3, FL3
Standard tension cord ²	Steel	Steel	Steel Aramid	
Special tension cord ² see Chapter 1.5	Aramid Highly flexible steel Stainless steel Vectran Polyester	Aramid Highly flexible steel Stainless steel	Highly flexible steel Stainless steel	
Optional without sleeve nose	—	—	+ ³	

¹ Double toothed profiles on request

² Aramid and special cords per profile on request

³ T10 profile available without sleeve nose, other profiles on request

1 PRODUCT DESCRIPTION

1.5 TENSION CORD MATERIALS AND DESIGNS, PULLEY TOOTH SYSTEM



1.5 Tension Cord Materials and Designs, Pulley Tooth System

Polyurethane timing belts of all product groups are generally provided with a galvanized steel tension cord. With the steel tension cord in standard design, almost all applications from power drives through to linear and conveyor drives are covered.

Depending on the product group, aramid tension cords or highly flexible and stainless steel tension cords are also offered.

A tension cord diameter is assigned to every single timing belt profile, according to which the corresponding production mould and the pertaining timing belt pulleys are designed. In the case of stronger cords with a larger diameter, usually an adjustment of the mould geometry is necessary for the use of standard pulleys. If stronger cords are used on moulds which are designed for a standard tension cord diameter, the timing belt pulleys diameters must be corrected mostly. Here, special pulleys are often required where in turn no timing belts with standard profiles can be used.

All profiles presented in Subchapter 1.4 of the Optibelt polyurethane timing belts run with a standard tooth system regarding the tooth system in timing belt pulleys. In this case, there is generally no special tooth system required.

Tension cord material: Steel in standard design, ST

Steel tension cords generally consist of thin, galvanized filaments that are twisted to strands. These strands are further twisted to form tension cords. Flexibility and strength mainly depend on the metallic cross profile and thus on the cord diameter.

Figure 1.5.1 shows an example of a steel cord cross profile in standard design with the diameter 0.9 mm e.g. for the AT10 profile, consisting of seven strands with three filaments each, i.e. 21 filaments in total.

The galvanized coating does not durably protect the steel so that corrosion particularly occurs at high humidity with increasing operating time.

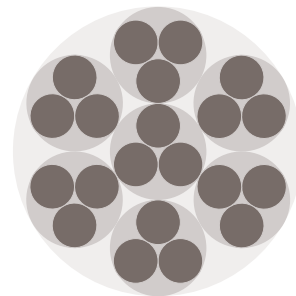

Figure 1.5.1: Tensile reinforcement structure 7 x 3 in cross profile

Tension cord material: Stainless steel, RF

In order to prevent corrosion on the tension cords in a wet or moist environment, the use of tension cords of stainless steel is recommended. Rust-free tension cords are applied, for example, in the food and pharmaceutical industry. The structure of a rust-free tension cord is identical with the standard steel tension cords. Tension cords of stainless steels feature a lower strength compared to steel tension cords of standard design. For the drive design, larger minimum pulley diameters and reduced permissible tension forces are to be taken into account.

Tension cord material: Steel of highly flexible structure, HF

Through the use of thinner filaments compared to the standard steel tension cords and an adjusted cord structure, the loads acting on the filaments can be clearly reduced.

Figure 1.5.2 shows a highly flexible steel cord with the diameter 0.9 mm e.g. for the AT10 profile, consisting of a centrally arranged strand of three filaments and five strands of seven filaments each.

The diameter of the cords with a highly flexible structure approximately correspond to the respective standard tension cords. Due to the larger metallic cross profile, an increased strength is achieved additionally.

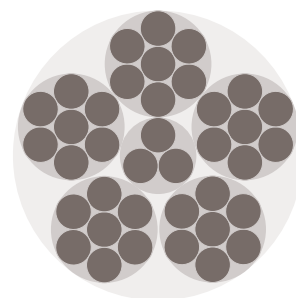

Figure 1.5.2: Tensile reinforcement structure 3 + 5 x 7 in cross profile

1 PRODUCT DESCRIPTION

1.6 MODE OF ACTION



Due to the higher bending flexibility, approximately 20 % smaller minimum timing belt pulley diameters can be implemented with these tension cords. An ideal application would be a drive with a back idler. In comparison to the standard steel tension cords, there is no durable corrosion protection in this case due to the galvanized coating.

Tension cord material: Aramid, AR

Aramid tension cords are less sensitive to impact loads than steel tension cords and are consequently primarily applied in drives exposed to impact loads. In addition, aramid cord is used in the food and pharmaceutical industries.

The bending flexibility of aramid cord is high so that very small timing belt pulley diameters are possible. At the same time, the reverse bending strength of aramid is reduced.

In comparison, aramid cord exhibits an elongation remaining at a higher level. Timing belts with aramid tension cords are hence not maintenance-free and not suitable for drives with a fixed drive centre distance. Aramid tends to swell and to an increasing belt tension at high moisture and contact with water.

Tensile reinforcement material: Polyester, PES

In a corrosive environment, e.g. water with a high chlorine content, tensile reinforcements of polyester can be used. The high elastic elongation of polyester cords, compared to the above tensile reinforcement materials, allows only a low specific load and requires an accordingly large sizing.

1.6 Mode of Action

Tooth engagement and pitch, simplified determination

The tooth systems of the timing belt and pulley are adjusted to each other and engage in the area of contact, see Figure 1.6.1.

The engaging teeth of the driving pulley transmit forces to the teeth of the belt which in turn transmit forces tooth by tooth to the tensile reinforcements. Between the pulleys, the teeth of the straight belt spans are relieved. The tensile reinforcements are only loaded with tensile forces, which these transmit in power drives, see Figure 2.1.1, at the driven pulley inversely tooth by tooth to its tooth system. In the case of linear drives, the tensile forces are transmitted to the tooth system of the tension plates instead.

Only in straight position, the pitch t is identical beyond the height of the belt. For a simple measurement of the pitch of the straight timing belt, e.g. two left or right edges of two neighbouring teeth are used in the trapezoidal tooth profile. A more precise measurement can be made over several teeth, e.g. over ten tooth pitches and eleven teeth. The measurement result is then divided by ten accordingly.

A precise measurement of pitch and length of the optibelt ALPHA LINEAR / V and partly of the ALPHA

FLEX timing belt is taken by a measuring instrument. An exact measurement of the pitch and length of the optibelt ALPHA TORQUE and ALPHA POWER requires a two-pulley measuring machine according to standard. The standards are indicated in Table 1.4.9. The tolerances to belt and pulley are indicated in Chapter 7.

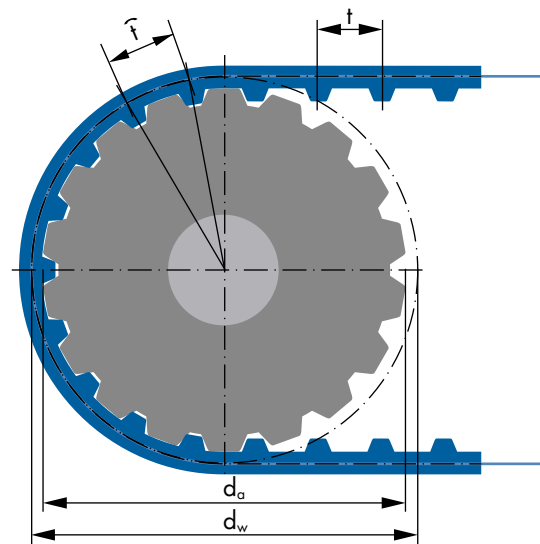

Figure 1.6.1: Timing belt in gear with the timing belt pulley

1 PRODUCT DESCRIPTION

1.6 MODE OF ACTION



In bent belt position, the pitch t is the arc length e.g. from tooth centre to tooth centre at the level of the effective line. This level is at the height of the tensile reinforcement central line. The pitches of the timing belt and timing belt pulleys are identical on the level of the effective diameter d_w . The effective diameter d_w of the timing belt pulley is therefore outside the pulley and hence bigger than the outside diameter d_o of the pulley.

$$d_w > d_o \quad \text{with } d_w [\text{mm}], d_o [\text{mm}]$$

The effective diameter d_w and the pitch or the arc length can generally not be measured directly, e.g. with a calliper. If the pitch of a timing belt pulley is nevertheless measured, in a strongly simplified way, directly at its teeth, the straight measurement of the pitch always leads to somewhat smaller values than the value of the real, curved pitch length. A further reason for a too small value is that the measurement must be taken underneath the effective line. The closer the measurement is taken towards the pulley centre, the smaller become the arc lengths. As shown in Figure 1.6.1, the pitch between belt and pulley on the level of the effective line must be identical as far as possible on the level of the effective line. This ensures that the belt tooth can enter and leave the tooth system of the pulley under minimum friction and deformation. This requires low-stretch tensile reinforcements, which distribute the circumferential force to as many engaging teeth as possible. In addition, the central line of the tension cord must always be exactly on the level of the defined effective line for a high pitch accuracy. As already mentioned in Subchapter 1.5, this is the case in all profiles of the Optibelt polyurethane timing belts presented under Subchapter 1.4 so that, related to the tooth system, basically all timing belts of the standard assortment can be used.

In the Optibelt assortment list, standard timing belt pulleys with tooth number z , outside diameter d_o and effective diameter d_w are indicated for many profiles. Subchapter 7.3 includes the pertaining outside diameter tolerances. A rough pitch determination of the timing belt pulley, as described above, should be verified and completed with a measurement of the outside diameter and the comparison with the respective outside diameter indicated in the assortment list.

1 PRODUCT DESCRIPTION

1.6 MODE OF ACTION



Forces in the two-pulley power drive

Representing all drive types, the forces in a timing belt drive are described for a power drive. Details about power, linear and transport drives are given in Chapter 2 and Chapters 3 to 5 for the respective drive type.

Figure 1.6.2 shows the tensile force distribution in the timing belt of a service drive with two pulleys. The area height corresponds to the size of the acting tensile force that is composed of the forces indicated below. The transmitted circumferential force at an identical span length is distributed in equal shares to the loading and unloading span.

Circumferential force

The circumferential force F_U transmitted by the timing belt mainly depends on the load bearing capacity of the teeth and the tensile reinforcements.

The power rating P_N or the rated tensile force F_N or alternatively the rated torque M_N , which can be derived from the load bearing capacity of the tooth, are all indicated in the respective Technical Data Sheet of the timing belt.

The same applies to the permissible tensile force F_{allowed} of the tensile reinforcements or the cords.

The rated load bearing capacity primarily depends on the diameter and the speed of the small or, depending on the drive type, the driving pulley. In addition, the type of the external loads and the drive geometry of each individual drive must be taken into account.

Belt tension

The static belt tension F_T of a timing belt is calculated and adjusted such that in the unloaded span a small residual belt tension is always maintained, even if the load increases. The centrifugal force portion of the static pre-tension force is not considered in timing belts generally and for simplification, as they are lighter compared to e.g. V-belts. The circumferential force to be transmitted is distributed, at equal span lengths and uniform run, in equal shares to the loading and unloading span. The remaining belt tension force prevents the timing belt from skipping teeth. The shaft forces are then almost constant even at low load variations.

Centrifugal forces

Growing speeds increase the centrifugal forces of the belt, with the shaft forces decreasing accordingly. As described above, centrifugal forces are not considered in timing belts for reasons of simplification.

Tooth forces

Engaging belt teeth transmit the circumferential force from the teeth of the pulley proportionally to the tension cords and vice versa. The load bearing capacity of a tooth is determined by its abrasion and shear strength. The performance of the timing belt can be primarily derived through its width b and the sum of the engaging teeth z_e , which is limited for the calculation to a maximum of twelve or for welded optibelt ALPHA V timing belts to six teeth.

Tension forces

The tension cord takes up the circumferential force tooth for tooth at the drive pulley and transmits it. At the driven pulley, the cord releases this circumferential force again through the tooth engagement. In addition, belt tension forces are applied to the tension cord that act in the same way in the spans as well as the areas in contact without an external load as static belt tension.

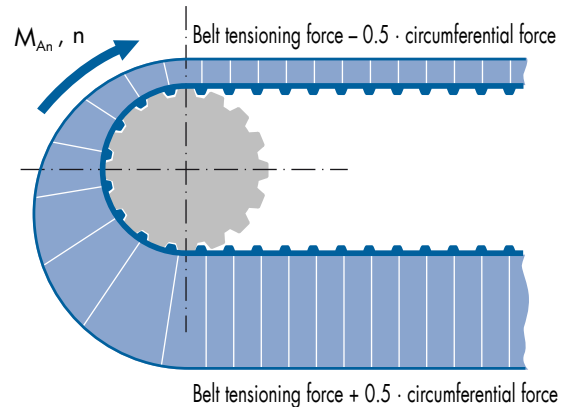

Figure 1.6.2: Tensile force distribution in timing belts

2 BASICS OF DRIVE DESIGN

2.1 GEAR DRIVE GEOMETRY, IMPORTANT PARAMETERS AND FORMULAS



2.1 Gear Drive Geometry, Important Parameters and Formulas

Belt geometry, important parameters

Figure 2.1.1 shows the main geometric parameters of a timing belt drive for power transmission with a speed ratio $i > 1$, consisting of a timing belt and two timing belt pulleys of the same tooth pitch t each and the suitable tooth profile.

In this speed ratio i , the small pulley with the tooth number z_k is the driving pulley on the shaft – with the diameter d – of the driving motor with the power P_{An} and the speed n_1 . These and the geometric parameters with the respective indices are assigned in Table 2.1.1 to the drive, belt and driven side.

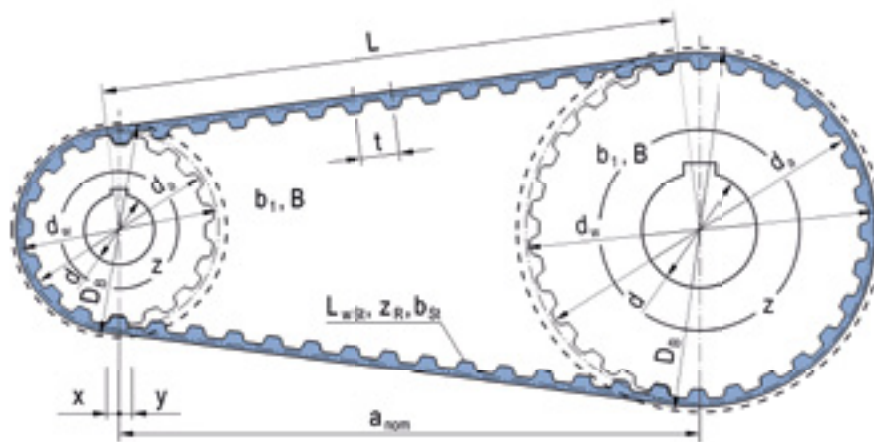

Figure 2.1.1: Gear drive geometry: Belts and pulleys

The parameters in Table 2.1.1 basically also apply, with the exception of P_{output} , M_{output} , to linear and conveyor drives.

Table 2.1.1: Assignment of basic parameters with physical units to the above power drive

Timing belt drive power drive with $i > 1$		
Drive Driving machine, pulley Indices: Input, 1, ...	Belt Indices: St, R, nom, ...	Driven side Driven machine, pulley Indices: Output, 2, ...
P_{input} [kW], M_{input} [Nm]	F_U [N], v [m/s]	P_{output} [kW], M_{output} [Nm]
P_N [kW], M_N [Nm], F_N [N]	$P_{N\ spec}$ [W/mm], $M_{N\ spec}$ [Nm/mm], $F_{N\ spec}$ [N/mm]	P_N [kW], M_N [Nm], F_N [N]
$F_{a\ st}$ [N], $F_{a\ dyn}$ [N]	F_T [N]	$F_{a\ st}$ [N], $F_{a\ dyn}$ [N]
n_1 [1/mm], d_{w1} [mm] and t [mm]	i , t [mm]	n_2 [1/mm], d_{w2} [mm] and t [mm]
z_1 , z_k with z_e (or z_g at $i < 1$)	L [mm], L_{wSt} [mm], z_R , a_{nom} [mm]	z_2 , z_g (or z_k with z_e at $i < 1$)
d_1 [mm], d_{a1} [mm], D_{B1} [mm]		d_2 [mm], d_{a2} [mm], D_{B2} [mm]
b_{11} [mm], B_1 [mm]	b_{St} [mm]	b_{12} [mm], B_2 [mm]
x [mm], y [mm]		or x [mm], y [mm]

here also $d_{w1} = d_{wk}$ and $d_{w2} = d_{wg}$ b_1 width of teeth, B total width = hub length (N hub length only ZRS with TB)

2 BASICS OF DRIVE DESIGN

2.1 GEAR DRIVE GEOMETRY, IMPORTANT PARAMETERS AND FORMULAS



In the case of a transmission ratio $i < 1$, where the driven speed n_2 exceeds the drive speed n_1 – transmission to a faster speed –, the drive speed n_1 refers to the large pulley z_g in deviation to Figure 2.1.1 and Table 2.1.1.

Pulley functions, terms and number of teeth

In power drives, the smaller pulley z_k is always crucial for the drive design and the determination of the engaging number of teeth z_e . Figure 2.1.1 shows a drive pulley with 16 teeth:

$z_1 = z_k = 16$. With $i = 1$ and $z_1 = z_2$, eight teeth would be engaged: $z_e = 8$.

Through the selected second larger pulley shown in Figure 2.1.1 $z_2 = z_g = 32$, the contact and hence the number of engaged teeth are slightly reduced at the smaller pulley, also depending on the existing drive centre distance a_{nom} : $z_e = 7$.

For drives with polyurethane timing belts, the number of teeth that is allowed to be considered for the calculation as a maximum is limited to twelve teeth and for welded optibelt ALPHA V timing belts to only six, see Table 2.1.2.

In contrast to the power drives, the drive pulley z_1 and the number of teeth engaged there z_e are always considered for the drive design in linear and conveyor drives. The second pulley serves here primarily as an idler to reverse the timing belt and does not take up any circumferential forces. In almost all cases, the second pulley z_2 features, in the function as an idler, the same dimensions as the drive pulley: $z_1 = z_2$.

Table 2.1.2: Engaging, maximum considered or calculation tooth numbers z_e , z_{emax} , z_{eB}

Power drives ALPHA TORQUE ALPHA POWER ALPHA FLEX		Linear drives ALPHA LINEAR		Transport drives ALPHA V	
$z_{emax} = 12$		$z_{emax} = 12$		$z_{emax} = 6$	
Timing belt pulley functions		Timing belt pulley functions		Timing belt pulley functions	
Drive Motor	Output Machine	Drive Motor	Idler Reverse	Drive Motor	Idler Reverse
$z_e = f(z_k, z_g, a_{nom})$	-	$z_e = z_1 / 2$	-	$z_e = z_1 / 2$	-
Output Machine	Drive Motor	Idler Reverse	Drive Motor	Idler Reverse	Drive Motor
$z_e = f(z_k, z_g, a_{nom})$	-	-	$z_e = z_1 / 2$	-	$z_e = z_1 / 2$
1. $z_{eB} = z_e$ $i = 1: z_e = z_k / 2$ 2. $z_{eB} \leq z_{emax}$		1. $z_{eB} = z_e$ 2. $z_{eB} \leq z_{emax}$		1. $z_{eB} = z_e$ 2. $z_{eB} \leq z_{emax}$	
$f(z_k, z_g, a_{nom})$ see Chapter 3.2		very rarely $z_1 \neq z_2$, if $z_1 = z_k$ z_e see Chapter 3.5 if $z_1 = z_g$ simplified $z_e = z_g / 2$			

2 BASICS OF DRIVE DESIGN

2.1 GEAR DRIVE GEOMETRY, IMPORTANT PARAMETERS AND FORMULAS



General formulas for external loads, rated capacity and geometry

Belt drives are often designed on the drive side through the motor as external load. This data is usually available. In general, the belt drive is safely dimensioned, if further special features are also taken into account, which are described in Chapter 2.2.

For a known load on the driven side, a design of the belt drive and the selection of the motor could be made through the drive. This optimisation is particularly economically feasible for large quantities.

Table 2.1.3: Formulas for external loads and rated capacity of the belt drive

Power P [kW]	Torque M [Nm]	Circumferential force F_u [N]
External loads		
Assignment to driving and driven side see also Tables 2.1.1 – 2.1.6		
$P = \frac{M \cdot n}{9.55 \cdot 10^3}$	$M = \frac{P \cdot 9.55 \cdot 10^3}{n}$	
$P = \frac{2 \cdot M \cdot v}{d}$	$M = \frac{P \cdot d}{2 \cdot v}$	
$P = \frac{F_u \cdot d \cdot n}{19.1 \cdot 10^6}$		$F_u = \frac{P \cdot 19.1 \cdot 10^6}{d \cdot n}$
$P = \frac{F_u \cdot v}{10^3}$		$F_u = \frac{P \cdot 10^3}{v}$
	$M = \frac{F_u \cdot d}{2 \cdot 10^3}$	$F_u = \frac{M \cdot 2 \cdot 10^3}{d}$
Rated capacity Linear, transport drive $z_k \rightarrow z_1$		
Formulas and specific parameters $P_{N \text{ spec}}$ and $F_{N \text{ spec}}$ also see data sheets about product groups and profiles		
$P_N = \frac{P_{N \text{ spec}} \cdot z_k \cdot z_{eB} \cdot b}{10^3}$	$M_N = \frac{P_N \cdot 9.55 \cdot 10^3}{n_k}$	$F_N = F_{N \text{ spec}} \cdot z_{eB} \cdot b$
$P_{N \text{ spec}} = \frac{F_{N \text{ spec}} \cdot n_k \cdot t}{6 \cdot 10^4}$	$M_N = \frac{F_N \cdot d_k}{2 \cdot 10^3}$	$F_{N \text{ spec}} = \frac{P_N \text{ spec} \cdot 6 \cdot 10^4}{n_k \cdot t}$

with b [mm], d [mm], d_k [mm], F [N], F_N [N], $F_{N \text{ spec}}$ [N/mm], F_u [N], M [Nm], M_N [Nm], n [min^{-1}], n_k [min^{-1}], P [kW], P_N [kW], $P_{N \text{ spec}}$ [W/mm], t [mm], v [m/s], z_1 [-], z_k [-], z_{eB} [-], see also Table 2.3.1: Formula symbols

Table 2.1.4: Formulas for effective diameter d_w , effective transmission i_{eff} , belt/pulley speed v

Timing belt drive		
Drive pulley	Belt	Driven pulley/idler
$d_{w1} = \frac{z_1 \cdot t}{\pi} \quad z_1 = \frac{d_{w1} \cdot \pi}{t}$	$i_{\text{eff}} = \frac{d_{w2}}{d_{w1}} = \frac{z_2}{z_1}$	$d_{w2} = \frac{z_2 \cdot t}{\pi} \quad z_2 = \frac{d_{w2} \cdot \pi}{t}$
	$i_{\text{eff}} = \frac{n_1}{n_{2\text{eff}}}$	
$v = \frac{d_{w1} \cdot n_1}{19.1 \cdot 10^3} = \frac{z_1 \cdot t \cdot n_1}{6 \cdot 10^4} \quad v = \frac{d_{w2} \cdot n_{2\text{eff}}}{19.1 \cdot 10^3} = \frac{z_2 \cdot t \cdot n_{2\text{eff}}}{6 \cdot 10^4}$		

with d_{w1} [mm], d_{w2} [mm], i_{eff} [-], n_1 [min^{-1}], $n_{2\text{eff}}$ [min^{-1}], t [mm], v [m/s], z_1 [-], z_2 [-], see also Table 2.3.1: Formula symbols

The index w indicates the effective line which is defined by the position of the tension cord.

2 BASICS OF DRIVE DESIGN

2.1 GEAR DRIVE GEOMETRY, IMPORTANT PARAMETERS AND FORMULAS



Circumferential forces and movement types

The following text explains Table 2.1.5, with the respective drive being indicated on the left side for simplification. Belt drives transmit a tensile force from the motor to different driven outputs and are therefore also referred to as traction drives.

This tensile force or circumferential force F_U basically overcomes

- the output torque M_{output} , **in power drives**,
- the acceleration force F_a **in horizontal linear drives** and
- the friction force F_R in horizontal transport drives.

In power drives, the rotary movement of the drive shaft generates a rotary movement of the driven shaft.

In contrast to this, the rotary movement of the drive shafts in linear and transport drives generates a straight movement over the distance s . In transport drives, the maximum conveying distance s can correspond to the span length L or the nominal drive centre distance a_{nom} .

The distance s of the linear slide of a linear drive is arranged underneath due to the spatial extent of the slide or the clamping plates which connect it with the belt ends.

Table 2.1.5: Assignment of external loads, parameters mass m , acceleration a , friction coefficient μ

Power drives		Linear drives		Transport drives	
Drive motor	Output machine	Drive motor	Linear slide	Drive motor	Goods conveyed
Rotary movement	Rotary movement	Rotary movement	Straight movement	Rotary movement	Straight movement
mostly in one direction and uniformly/constant		always in changing direction and non-uniformly/start – stop		mostly in one direction and uniformly/constant	
$F_U = \frac{M_{\text{output}} \cdot 2 \cdot 10^3}{d_{w2}}$		$F_{U1} = F_{a1} = m \cdot a_1$ $F_{U2} = F_{a2} = m \cdot a_2$		$F_U = F_R = (\mu_1 + \mu_2) \cdot m \cdot g$	
$P_{\text{input}} (P_N)$ $M_{\text{input}} (M_N), n_1$	P_{output} M_{output}, n_2	$P_{\text{input}} (P_N)$ $M_{\text{input}} (M_N), n_1$	m a_1, a_2	$P_{\text{input}} (P_N)$ $M_{\text{input}} (M_N), n_1$	m μ_1, μ_2
For start – stop and start under load: Observe M_A		Slide guidance: mostly $\mu \approx 0$		Acceleration: mostly $a \approx 0$ without accumulating conveyor $\mu_1 = 0$	

with a [m/s^2], a_1 [m/s^2], a_2 [m/s^2], d_{w2} [mm], F_{a1} [N], F_{a2} [N], F_U [N], F_{U1} [N], F_{U2} [N], m [kg], M_A [Nm], M_{output} [Nm], M_{input} [Nm], M_N [Nm], n_1 [min^{-1}], n_2 [min^{-1}], P_{output} [kW], P_{input} [kW], P_N [kW], s [mm], v [m/s], μ [-], μ_1 [-], μ_2 [-], see also Table 2.3.1: Formula symbols

2 BASICS OF DRIVE DESIGN

2.1 GEAR DRIVE GEOMETRY, IMPORTANT PARAMETERS AND FORMULAS



Power drives and transport drives are mostly driven at constant speeds n and belt or conveying speeds v after the start. Consequently, inertia forces or moments of inertia play no or only a minor role for the external load and can usually be covered in a simplified way with the base load factor c_0 , see Chapter 2.2.

In power drives, the output torque M_{output} that was taken on and the size of the lever arm determine the external load in correspondence with the radius of the driven pulley. The smaller the pulley, the larger the required circumferential force at a constant output moment.

In transport drives, the mass of the conveyed goods determines the external load through the friction coefficient μ_2 between belt and support rail using the friction force F_R . For accumulation conveyors, the friction coefficient μ_1 between conveyed goods and belt must be added.

In linear drives, the external load is predetermined through the continuous acceleration a_1 on the speed v and the subsequent deceleration a_2 up to the standstill of the moved mass m . For simplification, the mass of the linear slide and the payload is considered here. Moments of inertia of the pulleys and the belt mass can be represented in a simplified way through the base drive service factor c_0 . Low friction coefficients μ between linear slide and guidance can then likewise be ignored.

Linear and transport drives: Inclined conveyors and lifting drives

Table 2.1.6: Mass, friction forces for horizontal, inclined and vertical movements

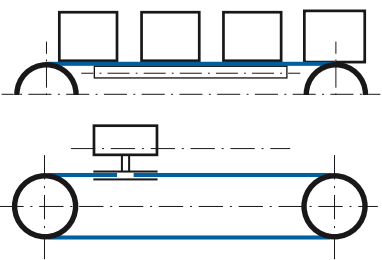
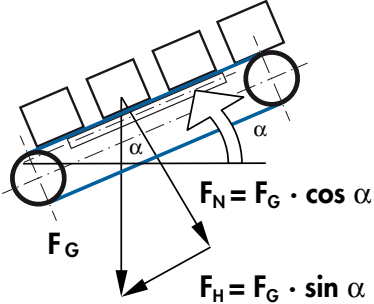
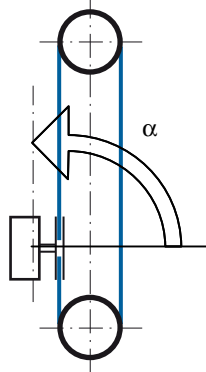
Horizontal movement	Inclined movement	Vertical (lifting) movement
 $\alpha = 0^\circ$	 $0^\circ < \alpha < 90^\circ$	 $\alpha = 90^\circ$
Linear drives $\mu \approx 0$		
$F_U = F_{U1} = m \cdot a_1$ with $\sin 0^\circ = 0$ for $a_1 > a_2$	$F_U = F_{U1} = m \cdot (a_1 + g \cdot \sin \alpha)$ for $a_2 < 2g + a_1$	$F_U = F_{U1} = m \cdot (a_1 + g)$ with $\sin 90^\circ = 1$ for $a_2 < 2g + a_1$
Transport drives $a \approx 0$		
$F_U = (\mu_1 + \mu_2) m \cdot g$ with $\sin 0^\circ = 0, \cos 0^\circ = 1$	$F_U = m \cdot g \cdot \sin \alpha + (\mu_1 + \mu_2) m \cdot g \cdot \cos \alpha$ for start - stop also see above a_1, F_{U1}	$F_U = m \cdot g$ with $\sin 90^\circ = 1, \cos 90^\circ = 0$

For parameters and units refer to Table 2.1.5 and Table 2.3.1: Formula symbols

2 BASICS OF DRIVE DESIGN

2.1 GEAR DRIVE GEOMETRY, IMPORTANT PARAMETERS AND FORMULAS



In transport drives, a distinction is made between horizontal, inclined and vertical conveyors. Vertical linear drives are called lifting drives.

In linear and transport drives that overcome a height difference, an additional acting force is the downward force F_H . With an increasing angle of inclination α the downward force F_H rises, until the full weight force F_G acts up to an inclination angle of 90° .

$$F_H = F_G \cdot \sin\alpha = m \cdot g \cdot \sin\alpha \quad \text{with } \sin(0^\circ \dots 90^\circ) = 0 \dots 1, \text{ see Fig. in Table 2.1.6}$$

With an increasing angle of gradient α the friction force F_R is reduced through the decreasing normal force F_N , see Table 2.1.6.

$$F_N = F_G \cdot \cos\alpha = m \cdot g \cdot \cos\alpha \quad \text{with } \cos(0^\circ \dots 90^\circ) = 1 \dots 0, \text{ see Fig. in Table 2.1.6}$$

$$F_R = \mu \cdot F_N = (\mu_1 + \mu_2) \cdot m \cdot g \cdot \cos\alpha$$

The triangle of forces is shown in Table 2.1.6 using the example of a transport drive and represented here in a simplified way for the sum of masses for only one single transport piece.

Static belt tensions of loaded and relieved drives, recommended belt tension force

Table 2.1.7 shows in the top and middle row of pictures, the distribution of forces in the belt drive under load for power, linear and transport drives. Here, the different force distributions are clearly shown and which are expressed at the bottom of the table in correspondingly differing static belt tension recommendations for the respective static belt tension F_T .

In Table 2.1.7, the circular arrow is placed at the drive pulley and indicates only the direction of movement. During starting and uniform movement, the direction of movement of the drive pulley corresponds with the acting drive torque of the motor.

During deceleration, however, the braking torque counteracts the direction of movement. In this case, here a deceleration a_2 , is shown in Table 2.1.7 only for the linear drive in the middle picture where this load condition occurs permanently. For power and transport drives, it is not necessary to consider the mostly low braking torque separately and it can be ignored. For braking torques higher than the drive torque, but especially in the case of stringent emergency off specifications and a minimum overrun time, this must be additionally taken into account at least in the final consideration of the drive design.

2 BASICS OF DRIVE DESIGN

2.1 GEAR DRIVE GEOMETRY, IMPORTANT PARAMETERS AND FORMULAS



For a perfectly safe operation of the belt drive and a maximum utilisation of the possible lifetime, the unloaded span must always exhibit a residual force. As a result, as many of the engaging teeth as possible are always involved in the force transmission and skipping under high load is reliably prevented. The so-called slack side should never be completely unloaded, after it has taken up the elongation of the tight side. This has also the purpose to prevent or reduce rapping of this side. The static belt tension force is higher in proportion to the circumferential force, the shorter the unloaded side is in proportion to the loaded side.

The loaded side, also called tight side, has generally only the same length as the unloaded side in two-pulley power drives. This applies irrespective of the selection of the drive pulley, see top and middle pictures, and irrespective of the respective sense of rotation.

In linear drives, the length of the loaded and unloaded sides changes continuously. In addition, the sides continuously alternate in their functions of loaded or unloaded. Compared to power transport drives linear drives sometimes exhibit the shortest unloaded side. Therefore the highest recommended belt tension force should be in proportion to the circumferential force.

In transport drives, the length of the loaded and unloaded sides depends on the load distribution on the belt. But the arrangement of the drive pulley is crucial. The top picture shows a long loaded side and a comparably short unloaded side. This arrangement of the drive pulley is called rear drive. In contrast, the middle picture shows a comparably short loaded side and a comparably long unloaded side. This arrangement of the drive pulley is called front drive.

With a clear over-dimensioning and selected drive service factors $c_2 \geq 2.5$, a moderate belt tension force increase due to the additional belt tension factor c_v is recommended, as the calculation of the static belt tension force is generally not oriented at the possible power potential of the selected wider timing belt or the larger timing belt profile, but only at the external load or the resulting circumferential force F_U . This is to ensure that under practical conditions, sufficient belt tension forces for a safe start are ensured, i.e. the belt is not under-tensioned related to its potential. In the case of e.g. a five-fold over-dimensioning ($c_2 = 5$) the belt tension factor c_v may theoretically be increased far beyond the simplified formula in Table 2.1.7 with $c_v = 1.4$ to the factor $c_v = 5$. According to experience, a permissible increase, related to the timing belt, to e.g. $c_v = c_2 / 2$ for large or very large drive centre distances may be suitable, if this is permitted by the shaft and bearing dimensions.

The recommended static belt tension should only be adjusted when the motor is switched off and must be performed without external loads. Only in this case, the produced static belt tension force is distributed equally on all sides during a standstill, as shown in the bottom row of pictures in Table 2.1.7. Tensioning between the pulleys in power drives and between a drive pulley and a conveyed item or a linear slide will automatically lead to measurement errors and to belt tension forces that are too high or too low. Before every control measurement, the timing belt should, if possible, be moved additionally to support the uniform force distribution and enable a first setting in the pulleys, especially with new belts.

2 BASICS OF DRIVE DESIGN

2.1 GEAR DRIVE GEOMETRY, IMPORTANT PARAMETERS AND FORMULAS



Table 2.1.7: Static belt tensions of loaded and relieved drives, recommendation for static belt tensions

Power drives	Linear drives	Transport drives
Belt tensions of loaded drives		
<p>Slack side</p> <p>Tight side</p>	<p>Slack side</p> <p>Tight sides</p> <p>a_1</p>	<p>Tight side, increasingly slack</p> <p>Rear drive</p> <p>Tight side</p>
<p>New drive, change of drive pulley and retaining the sense of rotation</p> <p>Tight side</p> <p>Slack side</p>	<p>Same drive, change from start a_1 to stop / braking a_2, still retaining the sense of rotation</p> <p>Tight side</p> <p>Slack sides</p> <p>a_2</p>	<p>New drive, change of drive pulley and retaining the sense of rotation</p> <p>Tight side, increasingly slack</p> <p>Front drive</p> <p>Slack side</p>
Static belt tension forces F_T unloaded, tensioned drives		
<p>$F_T = 0.55 \cdot c_v \cdot F_U$</p> <p>Always same span lengths, see top and middle pictures</p>	<p>$F_T = 1.0 \cdot c_v \cdot F_U$</p> <p>Partly very short unloaded span lengths, see example for movement to the right, top picture</p>	<p>$F_T = 0.75 \cdot c_v \cdot F_U$ $F_T = 0.5 \cdot c_v \cdot F_U$</p> <p>Short unloaded span length, see top picture Long unloaded span length, see middle picture</p>
<p>General with belt tension factor $c_v = 1.0$. With clear over-dimensioning, e. g. $c_2 \geq 2.5$, a belt tension increase is recommended. This generally applies also to very large drive centre distances.</p> <p style="text-align: center;">$c_v \geq \frac{c_2 - 1}{10} + 1$</p>		

2 BASICS OF DRIVE DESIGN

2.2 DRIVE SERVICE FACTORS, ALLOWANCES AND FORMULAS



2.2 Drive Service Factors, Allowances and Formulas

Total drive service factor c_2

The total drive service factor c_2 is composed of the base drive service factor c_0 and two further allowances c_6 and c_8 .

$$c_2 = c_0 + c_6 + c_8 \quad [-]$$

$$c_2 \geq \frac{M_A}{M_N}, \quad c_2 \geq \frac{M_{Br}}{M_N} \quad [-] \quad \text{At drive} \quad \text{with } M_A \text{ [Nm]}, M_N \text{ [Nm]} \text{ and } M_{Br} \text{ [Nm]}$$

$$c_2 \geq \frac{M_{Br}}{M_N \cdot i} \quad [-] \quad \text{At output} \quad \text{with } M_N \text{ [Nm]}, M_{Br} \text{ [Nm]} \text{ and } i \text{ [-]}$$

The total drive service factor c_2 should also consider a high starting load M_A and a high braking load M_{Br} at the drive or a high braking load at the output in proportion to the rated load M_N of the driving machine.

With frequent switching operations and high starting or braking loads, which thus become the main load – the power transmission itself steps into the background – an additional safety allowance must be added to the maximum determined quotient.

Table 2.2.1: Base drive service factor c_0

<div style="text-align: center; font-size: 2em; font-weight: bold;">c₀</div>	Load type and examples of driving machines			
	Constantly running Electric motor Fast-moving turbine Piston machine with high number of cylinders		Intermittent running Hydraulic motor Slow-moving turbine Piston machine with low number of cylinders	
	Base drive service factor c_0 for daily operating time			
Type of base load and examples of a driven machine	up to 16 h	above 16 h	up to 16 h	above 16 h
Light drives, joint-free and uniform running Measuring instruments Film cameras Office equipment Belt conveyors (light goods)	1.3	1.4	1.4	1.5
Medium drives, temporary operation with small to medium impact loading Mixing machines Food processors Printing machines Textile machines Packaging machines Belt conveyors (heavy goods)	1.6	1.7	1.8	1.9
Heavy drives, temporary operation with medium to strong impact load Machine tools Wood processing machines Eccentric drive Conveying systems (heavy goods)	1.8	1.9	2.0	2.1
Very heavy drives, continuous operation with strong shock loading Mills Calender Extruder Piston pumps and compressors Lifting gear	2.0	2.1	2.2	2.3

2 BASICS OF DRIVE DESIGN

2.2 DRIVE SERVICE FACTORS, ALLOWANCES AND FORMULAS



Base drive service factor c_0

The base drive service factor c_0 considers the daily operating hours and the type of driving and driven machine based on general experience values. The values indicated in Table 2.2.1 are to be understood accordingly as simplified guide values.

The value of the base drive service factor c_0 selected for the application must be higher the

- higher the masses or moments of inertia,
- lower the running regularities or the higher the non-uniformity of the drive,
- lower the running regularities or the higher the non-uniformity of the output,
- longer the daily operating times

are.

Depending on the ambient conditions of low or high temperatures and the influence of gaseous, liquid and solid substances, an additional increase of the base drive service factor c_0 may be required. Particularly under special ambient conditions that act directly on the belt drive, a practical test is advisable.

Pulley and idler allowance c_6 and start frequency allowance c_8

The pulley and idler allowance c_6 and the allowance for the start frequency under load c_8 , see Table 2.2.2, are simplified guide values as the base drive service factor c_0 and are added to it, if required.

The allowance c_6 also applies to the use of further driven pulleys, which have to be checked separately, if required, depending on their output parameters of the design. Particularly for multi-pulley drives, it is recommended to perform the design with the optibelt CAP program.

Table 2.2.2: Pulley and idler allowance, start frequency allowance

Type of operating conditions	Designation and guide value of the allowance	Comment
Use of tension and idler pulleys	$c_6 = 0.2$	0.2 per idler a total of maximum 1.0
Operations (on/off) and/or reversing operation under load	$c_8 = 0.1 \dots 0.3$	depending on frequency at low starting load to approx. 1.5 times normal running load (e.g. star-delta start)
	$c_8 = 0.3 \dots 0.5$	depending on frequency with high starting load over approx. 1.5 times normal running load

Length factor c_3

The guide values of the length factor c_3 are indicated in Table 2.2.3 and apply only to rotationally highly loaded power drives which are mostly equipped with optibelt ALPHA TORQUE, ALPHA POWER or ALPHA FLEX timing belts.

The length factor c_3 considers the comparatively increasing or decreasing number of bending changes or tooth loads by using relatively short or long timing belts.

Table 2.2.3: Belt length correction factor

Profile	Effective length L_w [mm]	Length factor c_3
MXL, T2.5	≤ 190	0.8
	$> 190 \leq 260$	0.9
	$> 260 \leq 400$	1.0
	> 400	1.1
XL, T5, AT5	≤ 440	0.8
	$> 440 \leq 555$	0.9
	$> 555 \leq 800$	1.0
	> 800	1.1
L, T10, AT10	≤ 600	0.8
	$> 600 \leq 920$	0.9
	$> 920 \leq 1500$	1.0
	> 1500	1.1
T20, AT20	≤ 1260	0.8
	$> 1260 \leq 1880$	0.9
	$> 1880 \leq 3000$	1.0
	> 3000	1.1

2 BASICS OF DRIVE DESIGN

2.3 FORMULA SYMBOLS



2.3 Formula Symbols

Table 2.3.1 defines the basic parameters and the associated units which are used in the formulas of this Technical Manual.

Table 2.3.1: Formula symbols

Formula symbol	Explanation	Unit	Formula symbol	Explanation	Unit
a	Intended drive centre distance	[mm]	L_{wSt}	Standard effective length of the endless timing belt ALPHA TORQUE / POWER	[mm]
a_{nom}	Drive centre distance with selected belt length	[mm]	L_{wth}	Preliminary theoretical effective length	[mm]
a_1, a_2	Acceleration, deceleration	[m/s ²]	m	Mass	[kg]
B_1, B_2	Hub length of timing belt pulleys	[mm]	M_A	Starting load	[Nm]
b_{11}, b_{12}	Width of timing belt pulleys at tooth system	[mm]	M_{output}	Belt output load	[Nm]
b	Timing belt width	[mm]	M_{input}	Drive torque	[Nm]
b_{St}	Standard timing belt width	[mm]	M_{BN}	Calculation drive torque including c_2	[Nm]
b_B	Required (calculation) timing belt width	[mm]	M_N	Normal running load of the timing belt/drive	[Nm]
c	Spring rate	[N]	n_k	Speed of the small timing belt pulley	[min ⁻¹]
c_0	Base drive service factor	[-]	n_1	Speed of the driving timing belt pulley	[min ⁻¹]
c_2	Total drive service factor	[-]	n_2	Intended speed of the driven timing belt pulley	[min ⁻¹]
$c_{2actual}$	Existing total drive service factor	[-]	n_{2eff}	Speed of the driven pulley according to number of teeth of pulley	[min ⁻¹]
c_3	Length factor	[-]	P_{input}	Drive power	[kW]
c_6	Pulley and idler allowance	[-]	P_{output}	Output power	[kW]
c_8	Allowance for the starting frequency under load	[-]	P_B	Design power including total drive service factor	[kW]
c_{spec}	Specific spring stiffness of the timing belt	[N]	P_N	Rated power of the timing belt/drive	[kW]
c_v	Belt tension factor	[-]	$P_{N spec}$	Specific rated power of the timing belt transferable per tooth	[W/mm]
d_a	Outside diameter of pulley	[mm]	s	Drive span length	[mm]
D_B	Flange outside diameter	[mm]	s_v	Drive span length at constant velocity	[mm]
d_{wg}	Effective diameter of the large timing belt pulley	[mm]	s_b	Acceleration/deceleration length	[mm]
d_{wk}	Effective diameter of the small timing belt pulley	[mm]	t	Tooth pitch	[mm]
d_{w1}	Effective diameter of the driving pulley	[mm]	t_v	Drive span time at constant velocity	[s]
$d_{w1 th}$	Preliminary effective diameter, driving pulley	[mm]	t_b	Acceleration/deceleration time	[s]
d_{w2}	Effective diameter of the driven pulley	[mm]	v	Intended velocity of the belt	[m/s]
f	Frequency of the oscillating span side	[1/s]	v_{eff}	Effective velocity	[m/s]
F_a	Acceleration force	[N]	x, x_{cp}	Allowance for tensioning a shaft, a clamping plate	[mm]
$F_{a sta}$	Static shaft loading with static belt tension	[N]	x_v, x_{vcp}	Tension length for correct belt tension	[mm]
F_{Br}	Breaking load of the cords of the timing belt	[N]	y	Allowance for fitting	[mm]
F_H	Lifting or downward force	[N]	z_e	Number of teeth in engagement with the small pulley	[-]
F_N	Rated tensile force of the timing belt	[N]	z_{eB}	Number of engaged teeth to be considered for calculation, small pulley	[-]
$F_{N spec}$	Specific rated tensile force of the timing belt transferable per tooth	[N/mm]	z_{eBmax}	Maximum number of engaged teeth to be considered for calculation, small pulley	[-]
F_R	Friction force	[N]	z_k	Number of teeth of the small pulley	[-]
F_T	Static tension force	[N]	z_g	Number of teeth of the large pulley	[-]
F_U	Circumferential force or also output force	[N]	z_R	Number of teeth of the timing belt	[-]
F_{BU}	design circumferential force including c_2	[N]	z_1	Number of teeth of the driving pulley	[-]
$F_{allowed}$	Permissible tensile force of the belt cords	[N]	z_2	Number of teeth of the driven pulley	[-]
i	Intended speed ratio	[-]			
i_{eff}	Speed ratio according to number of teeth of the pulley	[-]			
L	Span length	[mm]			
L_v	Marked base length of the unloaded timing belt	[mm]			
ΔL_v	Elongation with correct belt tension	[mm]			
L_w	Effective length of the timing belt	[mm]			

3 POWER DRIVES

3.1 GENERAL



3.1 General

Chapters 1.1 to 1.3 contain, for example, the applications, characteristics, production processes and structures of all product groups of the polyurethane timing belts. These are summarised in this chapter for power drives and the pertaining product groups optibelt ALPHA TORQUE, ALPHA POWER and ALPHA FLEX.

The product groups optibelt ALPHA TORQUE, ALPHA POWER and ALPHA FLEX are equipped with polyurethane of the hardnesses 84 Shore A, 86 Shore A and 92 Shore A and can therefore safely transmit the power without an additional tooth-side fabric – see Figure 3.1.1. The optibelt ALPHA FLEX timing belt can be provided with a thin tooth-side fabric for friction and noise minimisation if required see Figure 1.3.4. In general, however, the mentioned polyurethane timing belts do not reach the performance level of high-performance rubber timing belts such as optibelt OMEGA HP or HL. The main benefits of the timing belts of polyurethane in comparison to rubber timing belts are:

- High abrasive resistance
- Good to very good resistance to oils, greases and a number of aggressive chemicals
- Non staining
- High ozone and UV resistance

The product group optibelt ALPHA FLEX extends the application spectrum to large drives which are additionally available in the HTD profile:

- Length range from approx. 1 100 to 22 000 mm
- Length range producible in separation stages

Up to a length of 2250 mm the cast optibelt ALPHA TORQUE and ALPHA POWER timing belts can be produced in a more economic manner than optibelt ALPHA FLEX timing belts. Since with the optibelt ALPHA POWER it is possible to offer a 30 % performance-increased design as opposed to optibelt ALPHA TORQUE and ALPHA FLEX, narrow and lower-priced drives can be implemented with it.

Product group	Performance
ALPHA POWER	130 %
ALPHA TORQUE ALPHA FLEX	100 %

Due to the very good mouldability of cast polyurethane, also small profiles such as T2, AT3 are available in addition to the large profiles such as T20 and AT20, but also very small notched tooth profiles such as TR10, TR15 with the pitches 1.0 mm and 1.5 mm on request. If a drive is to be operated with frequently changing speeds, the standard aluminium pulleys which are lighter than imperial and HTD cast pulleys can be used in the profiles T and AT and which can even further reduce the overall drive weight.

Table 3.1.1: Product groups and applications

Power drives	
ALPHA TORQUE ALPHA POWER	ALPHA FLEX
endless	
Application examples	
Machine tools Textile machines Printing machines Packaging machines Office equipment Medical appliances Robots Handling devices	

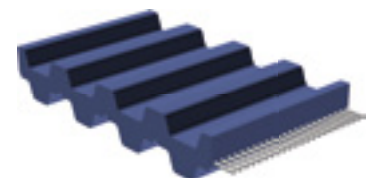

Figure 3.1.1: optibelt ALPHA TORQUE / POWER and ALPHA FLEX, single profile and double profile

3 POWER DRIVES

3.1 GENERAL



The optibelt ALPHA TORQUE and ALPHA POWER timing belts feature the following characteristics:

- Moulding in casting process, mostly a helically wound tension cord of steel
- High separation precision
- Strong attachment of polyurethane to tension cord
- optibelt ALPHA POWER with improved mechanical properties
- Useful sleeve widths of up to 380 mm
- Belt lengths up to 2250 mm
- Fine contouring, e.g. cast cleat
- Free colour selection possible from two sleeves
- Double profile design available
- Position of tolerance field slightly variable, e.g. for fix drive centre distances
- No direct welding of cleats
- No optional polyamide fabric on tooth and top surfaces
- No EU food compliance / FDA

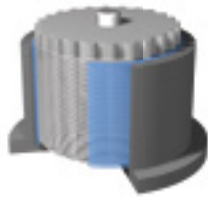

Figure 3.1.2: Moulding in a casting process with helically wound tensile reinforcement

The optibelt ALPHA FLEX belts feature the following characteristics:

- Extruded and moulded polyurethane with helically wound tensile reinforcements of steel
- Double winding with one S+Z cord
- Length range from approx. 1100 to 22 000 mm
- Length range producible in separation stages
- Production widths 100 mm or 150 mm
- Double profile design available
- PAZ, polyamide fabric possible on tooth system
- No polyamide fabric on top surface
- Direct welding of cleats and V-guides
- Optional PU with EU Declaration of Compliance / FDA, see www.optibelt.com
- Design etc. possible with highly flexible tension cords

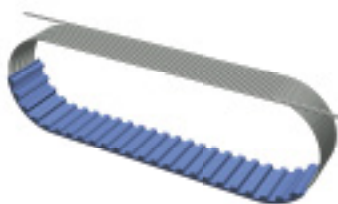

Figure 3.1.3: Extruded and moulded polyurethane with helically wound tensile reinforcements

Table 3.1.2: Product groups, lengths, profiles and features

	Product lines	
	ALPHA TORQUE ALPHA POWER	ALPHA FLEX
	cast, endless	extruded, endless
Largest length	2250 mm	22 000 mm
Intermediate lengths	see Assortment List	in indexing steps
Base profiles	Profiles	
Imperial profile	MXL, XL, L (ALPHA TORQUE)	H
T profile	T2.5, T5, T10 DT5, DT10	T5, T10, T20 DT5, DT10
AT profile	AT5, AT10	AT5, AT10, AT20, DAT5, DAT10
HTD profile		5M, 8M, 14M, D5M, D8M
Standard colour	transparent ¹ grey ¹	white
Standard hardness	84 Shore A ¹ 86 Shore A ¹	92 Shore A
Standard tension cord	steel	steel
PAZ, on tooth system	–	+ optional
PAR, on top surface	–	–
Special hardness	60-95 Shore A	85 Shore A
Special colour	on request according to RAL No.	e.g. black, blue, on request according to RAL No.
Minimum quantity for special hardness, colour	two sleeves	from 200 m with max. production width
Special tension cord on request see Chapter 1.6	aramid highly flexible steel stainless steel vectran polyester	aramid highly flexible steel stainless steel
Without sleeve nose	–	–
PU (FDA): Hardness, colour	–	85 Shore A, blue, optionally transparent

¹ optibelt ALPHA TORQUE, 84 Shore A, transparent;
optibelt ALPHA POWER, 86 Shore A, grey; ± 4 Shore A each

3 POWER DRIVES

3.2 VARIANTS



3.2 Variants

The main application of the polyurethane timing belts of the product groups optibelt ALPHA TORQUE / POWER and ALPHA FLEX is the synchronous transmission of power and speed in many areas of mechanical engineering and beyond. Due to the described various features, polyurethane timing belts can be used to implement drives, which cannot be designed at all or only under high costs with other drive elements or rubber timing belts.

The major portion of power drives are two-pulley drives. Due to the small minimum pulley diameters, also large speed ratios can be implemented which are slip-free and maintenance-free. Here, a large Optibelt product range can be utilised for timing belts and timing belt pulleys. Figure 3.2.1 shows a two-pulley drive with a speed ratio $i \neq 1$, where the small timing belt pulley with flanges on both sides also takes over the generally required lateral guidance of the timing belt, also see Chapter 7.

It should be possible to tension timing belts by at least one adjustable shaft. However, drives can also be designed without the possibility for tensioning, which then have a reduced performance and restricted length tolerances.

Due to the high flexibility of the belt, multi-shafts or serpentine drives can be implemented, where contact with the pulleys can additionally be achieved or increased with idlers arranged inside or outside. For a smooth belt top surface, they are of cylindrical and smooth design. Inside idlers can also be cylindrical-smooth or designed for an AT profile – e.g. as a timing belt pulley on the tooth side.

If the speed needs to be reversed, the corresponding timing belt pulley must engage outside in a double profile timing belt, as represented for one or two pulleys in Figures 3.2.2 and 3.2.3.

Possible arrangements of tension, guide or idler pulleys can be seen in figs 3.2.1 to 3.2.3.

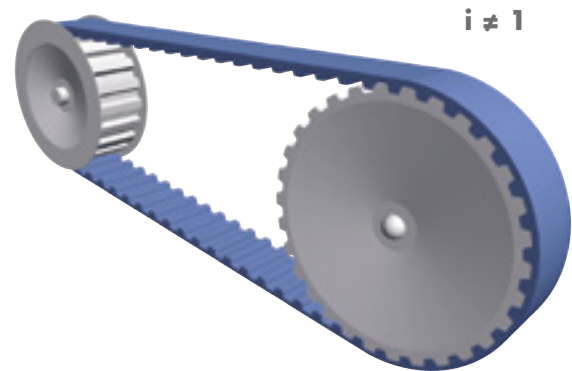

Figure 3.2.1: Two-pulley drive with $i \neq 1$



Figure 3.2.2: Multi-pulley drive with inside, smooth cylindrical pulley

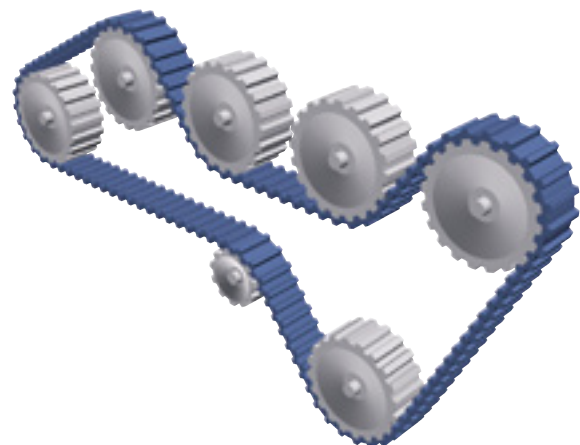

Figure 3.2.3: Multi-pulley drive with exterior timing belt pulley

3 POWER DRIVES

3.3 BASICS FOR DRIVE DESIGN

3.4 TIMING BELT PRE-SELECTION



3.3 Basics for Drive Design

The general formulas to the basic physical variables such as power P , torque M and circumferential force F_U are indicated in Subchapter 2.1.

Guide values for drive service factors and allowances are addressed in Subchapter 2.2.

General formula symbols are indicated in Subchapter 2.3.

For an application such as linear or transport drives, the subchapters for drive design 4.5 and 5.5 should be noted. In addition, formulas for physical variables such as velocity v and acceleration a are indicated in Subchapter 4.4.

3.4 Timing Belt Pre-selection

Selection of tooth system

All available profiles of the product groups optibelt ALPHA TORQUE / POWER and ALPHA FLEX timing belts are suitable for use in power drives.

The following overview summarises the basic characteristics of the tooth systems for these profiles

HTD profiles

- The HTD profile of the ALPHA FLEX timing belt is an arc profile that features a smoother run compared to a trapezoidal tooth.
- The largest tooth height leads to the highest skip protection in all tooth systems.
- The profile designation stands for "high torque drive". It was developed for highly loaded drives and is used today in new designs primarily for power drives.
- The HTD profile has a large width at the tooth base and exhibits hence a high shear strength and a high permissible specific tooth force. The belt webs between the teeth rest on the tooth heads of the tooth system of the pulleys.
- Standard timing belt pulleys of grey cast iron or steel are more wear-resistant than aluminium pulleys.

AT profiles

- The AT timing belt exhibits the highest tooth shear strength or the highest permissible specific tooth force of all trapezoidal profiles.
- In contrast to the other trapezoidal profiles, the tooth is supported on the tooth head area in the tooth gaps of the tooth system of the pulleys.
- Standard timing belt pulleys of aluminium feature a reduced service life compared to e.g. grey cast iron.

T profiles

- The most widely used metric T profile has a trapezoidal shape as the imperial profile. In new designs, this profile is selected for drives that are specifically exposed to low loads.
- Due to the thinner tension cord diameters and the smaller teeth compared to the AT and HTD profiles, the belt is more flexible and can be placed on smaller tooth pulley diameters.
- The belt web between the teeth is supported on the tooth heads of the tooth system of the pulleys. In e.g. heavily dust-loaded environments, the larger backlash or the larger clearance between belt and pulley can minimise the tendency to build up accumulations as opposed to the AT profile.
- Standard timing belt pulleys of aluminium feature a reduced service life compared to e.g. grey cast iron.

Imperial profiles

- Today, the imperial, trapezoidal profile is hardly used any more in new designs, particularly in the European area. The characteristics basically correspond to those of the T profiles.

3 POWER DRIVES

3.4 TIMING BELT PRE-SELECTION



Maximum belt speeds

The belt speeds indicated in Table 3.4.1 represent guide values which should not be exceeded depending on the drive design.

Table 3.4.1: Standard widths and maximum belt velocities

Profile	MXL	XL	L	H	XH	T2.5	T5	T10	T20	AT5, 5M	AT10, 8M	AT20, 14M
b ¹ [mm]	6.4	9.5	25.4	76.2	101.6	6	25	50	100	25	50	100
v _{max} [m/s]	80	80	60	60	40	80	80	60	40	80	60	40

¹ Largest width of standard timing belts and standard timing belt pulleys, see Optibelt product lists or simplified defined width

For belt velocities in the range of the guide values, a considerable running noise can be expected so that an enclosure may be required depending on the environment.

In addition, an increased static belt tension F_T may be necessary.

From approx. 30 m/s, a dynamic balance of the timing belt pulleys may be necessary, also see Subchapter 7.3.

Pre-selection of profile and width

The speed-dependent upper performance limits of the individual timing belt profiles in these diagrams are based on a timing belt pulley with 60 teeth for optibelt ALPHA TORQUE and ALPHA FLEX or a timing belt pulley with 46 teeth for optibelt ALPHA POWER. The optibelt ALPHA POWER transmits 30 % more power than the above mentioned product groups. This output increase is not separately entered due to the short logarithmic representation of Diagrams 3.4.1 and 3.4.2.

In addition, the respective maximum width of Table 3.4.1 of the combination of standard timing belt and standard timing belt pulley was used as a basis.

If special timing belt pulleys are used, the application of wider belts is possible. As a result, the power transmission can be increased accordingly.

For smaller pulley diameters, a lower number of teeth in gear than twelve or a lower timing belt width, the upper power limit is correspondingly higher.

3 POWER DRIVES

3.4 TIMING BELT PRESELECTION



Diagram 3.4.1: Power diagram, imperial profiles

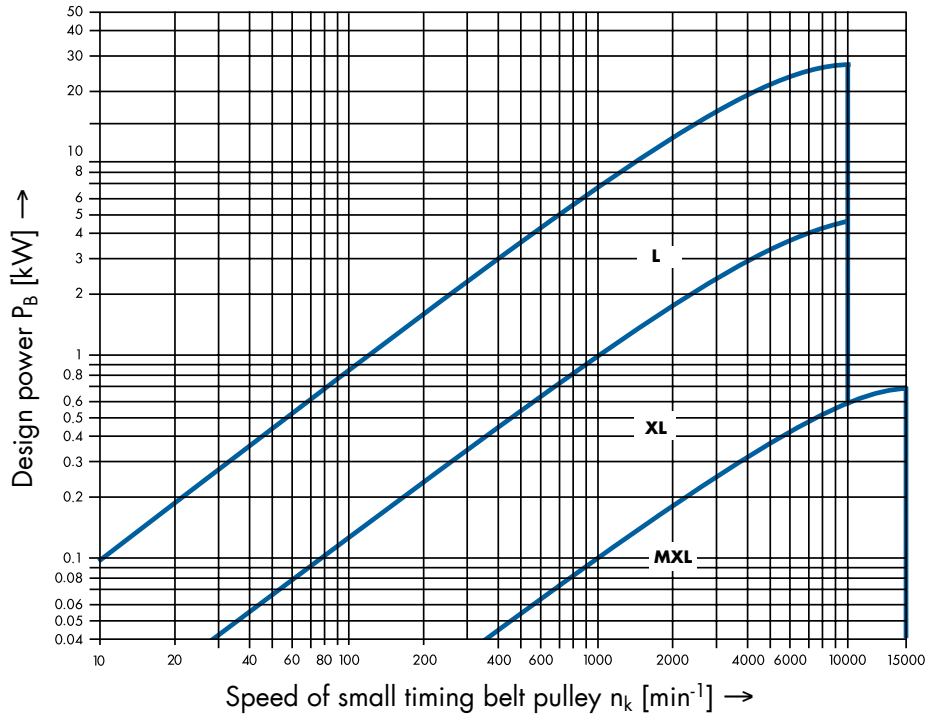
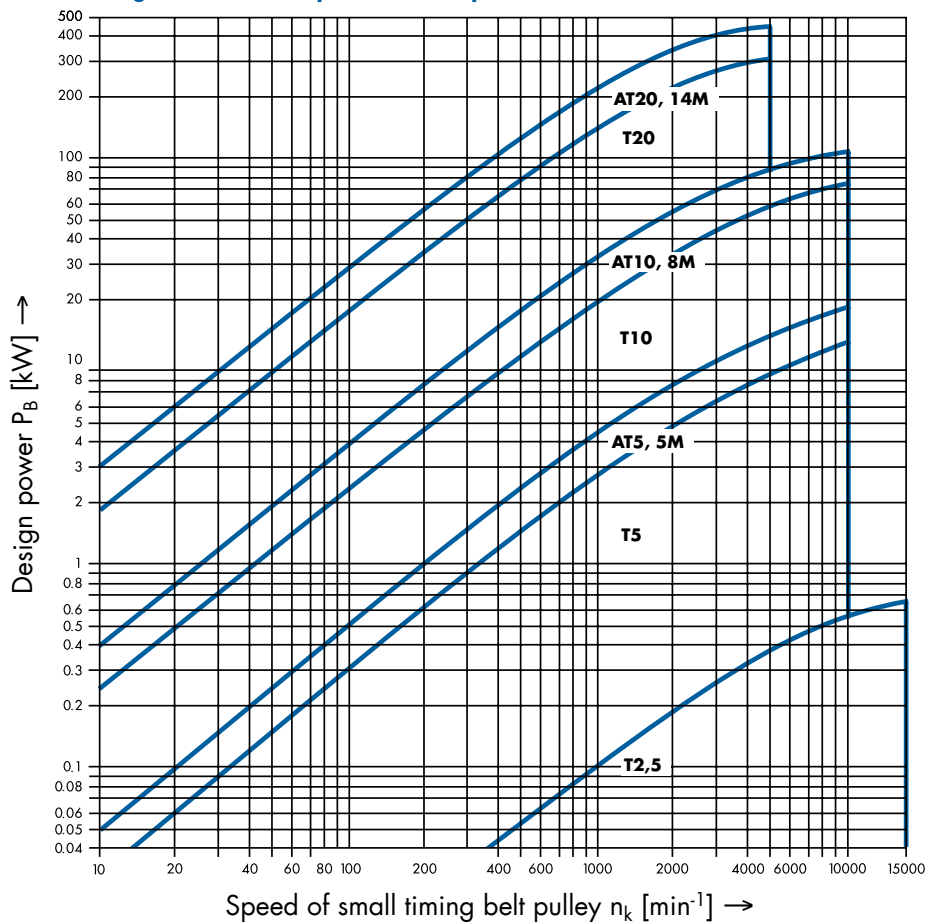

Diagram 3.4.2: Power diagram, T and AT profiles, HTD profiles



3 POWER DRIVES

3.5 DRIVE DESIGN



3.5 Drive Design

Requirement

In the following calculation example, a drilling machine is to be driven. Since the influence of drilling emulsion and friction-minimizing oils on the drive cannot be avoided here for design reasons, a polyurethane timing belt is intended for the drive.

Since a blockade cannot be excluded during operation, the maximum acting torque on the drive side is limited by a sliding clutch to three times the normal running load.

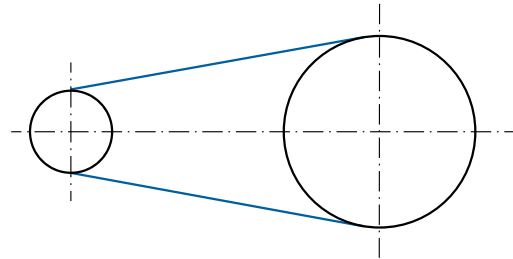

Figure 3.5.1: Two-pulley power drive

Prime mover		Drive conditions		Driven machine	
Drive:	electric motor	Operating time/day:	max. 16 hours	Output:	drilling machine
Power:	$P_{\text{input}} = P_N = 4.5 \text{ kW}$	Starts/day:	approx. 150	Power:	$P_{\text{output}} = ? \text{ kW}$
Speed:	$n_1 = 1450 \text{ min}^{-1}$	Ambient conditions:	room temperature, influence drilling emulsion, oils	Speed:	$n_2 = 600 \pm 10 \text{ min}^{-1}$
Starting torque:	$M_A = 2 \cdot M_N$	Load type:	medium impact load	Starting:	without load
Overall height:	freely selectable	Special feature:	blockade possible slide clutch: $3 \cdot M_N$	Overall height:	< 300 mm
Overall width:	$b_1, B < 100 \text{ mm}$	Drive centre distance:	$a = 410 \pm 20 \text{ mm}$	Overall width:	b_1, B freely selectable

Calculation methods

The drive design is performed by determining the design power. This is based on

- the drive power P_{input} of the driving machine or
- the drive power P_{output} of the driven machine or
- the maximum acting torques of driving or driven machine.

In most cases, the calculation is made through the drive power P_{input} , as this is known according to the motor selection in contrast to the output power. If the output power P_{output} is known, the calculation can basically also be made using this to achieve a more economic design of the timing belt drive.

High starting loads must be included in the design, since a short-term overloading in timing belts cannot be limited by an overload slip, but acts in its full extent without any reduction.

Total drive service factor c_2

The total drive service factor c_2 is composed of the type of the base drive service factor c_0 , the additional loads through pulleys c_6 and the starting frequency c_8 , see Subchapter 2.2.

$$c_2 = c_0 + c_6 + c_8 \quad \text{see Tables 2.2.1 and 2.2.2}$$

Without the blockade tendency of the driven machine the base drive service factor c_0 could be selected in a smaller value than 2.0, e. g. 1.7, see Table 2.2.1. The starting load which would justify a c_0 of 2.0 acts here during starting without load and the comparably few moments of inertia and can be ignored.

3 POWER DRIVES

3.5 DRIVE DESIGN



$$c_2 = 1.7 + 0 + 0 = 1.7 \quad c_0: \text{medium drive} \quad c_6: \text{no idlers} \quad c_8: \text{without load}$$

As occasional blockades of the drill have to be assumed, the base drive service factor c_0 must be increased clearly to ensure a durable function reliability. The slide clutch used limits the acting loads of the motor to three times the normal running load.

The base drive service factor c_0 and the total drive service factor c_2 can be equalised here, since for this operating condition of an occasional blockade influences through e.g. idlers have no significance.

$$c_2 = 3.0 + 0 + 0 = 3.0 \quad \text{The condition } c_2 \geq \frac{M_{Br}}{M_N} \text{ is consequently met.}$$

Design power P_B

The design power P_B can be derived from the output power and the total drive service factor c_2 . If the output power is not known, the drive power is used for the determination as in this example.

$$P_B = P_{\text{input}} \cdot c_2 \quad [\text{kW}] \quad \text{with } P_{\text{output}} [\text{kW}] = P_N [\text{kW}] \text{ and } c_2 [-]$$

$$P_B = 4.5 \text{ kW} \cdot 3.0 = 13.5 \text{ kW}$$

Selection of tooth system

The AT tooth profile should be selected which enables a comparably low overall height and width due to the high tooth loading capacity and the strong cords.

Belt pre-selection of profile and width – Based on the above calculation

According to the diagram 4.3.2, an optibelt ALPHA TORQUE 50 AT10 timing belt would be selected. The diagram is related to $z = 60$ teeth, i.e. a comparatively large timing belt pulley. In the case of higher requirements regarding the performance, an optibelt ALPHA POWER timing belt could likewise be used here.

Timing belt pulleys

The selection of the pulley diameter, related to maximum values, is primarily determined by the existing installation space. In addition, a sufficient space for the installation and dismantling of the belt must be provided. The belt height is shown e.g. on chapter 3.6's Technical Data Sheet and the outside diameter d_a of the selected timing belt pulley or the diameter of the existing flange D_B is shown e.g. on the Optibelt product range list. The associated hub and tooth widths or the timing belt pulley designs are shown as well.

The selection of the pulley diameter, related to minimum values, is determined by the required shaft diameter and the shaft/hub connection, see assortment list. The major features of the shaft/hub connections are detailed in Subchapter 7.2.

By selecting the belt profile and its technical design, the associated minimum number of teeth z_{min} and the minimum pulley diameter $d_{w\text{min}}$ of the timing belt pulley are defined, see Technical Data Sheet. The minimum pulley diameter for belts with steel cord are additionally indicated in Subchapter 7.3 and Table 7.3.4. For a first estimate, they can be seen in a simplified way in the Optibelt product range list.

The selected number of teeth of a standard pulley is indicated in the product range list. As an alternative and in special timing belt pulleys, the number of teeth z is calculated based on the profile of pitch t of the selected belt profile and the intended pulley diameter. The initial effective diameter of the driving pulley is defined in the following example with $d_w = 80$ mm.

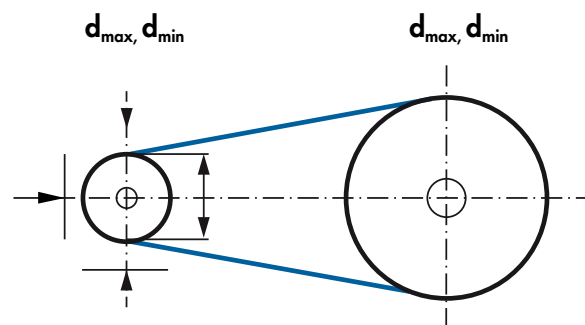

Figure 3.5.2: Geometric requirements determined e.g. by installation space and shaft/hub connection

3 POWER DRIVES

3.5 DRIVE DESIGN



$$z_1 = \frac{d_w \cdot \pi}{t} \quad [-] \quad \text{with } d_w \text{ [mm]} < d_{\max}, t \text{ [mm]} \text{ per profile}$$

$$z_1 = \frac{80 \text{ mm} \cdot \pi}{10 \text{ mm}} = 25.13 \quad \text{selected } z_1 = 25 \quad z_1 > z_{\min} = 15 \quad \text{also see Technical Data Sheet}$$

$$d_w + 2 \cdot h \text{ or } D_B + 2 \cdot h = 83 \text{ mm} + 2 \cdot 5.0 \text{ mm} = 93 \text{ mm} < 100 \text{ mm}$$

From the standard product range, the driving timing belt pulley with a number of teeth of $z = 25$, an effective diameter $d_w = 79.58 \text{ mm}$ and two flanges with a diameter $D_B = 83 \text{ mm}$ is selected.

$$z_2 = z_1 \cdot i = z_1 \cdot \frac{n_1}{n_2} \quad [-] \quad \text{with } z_1 \text{ [-]} \text{ and } i \text{ [-]} \quad i = \frac{n_1}{n_2} \text{ with } n_1 \text{ [min}^{-1}\text{]} \text{ and } n_2 \text{ [min}^{-1}\text{]}$$

$$z_2 = 25 \cdot 2.42 = 60.5 \text{ selected } z_2 = 60 \quad i = \frac{n_1}{n_2} = \frac{1450 \text{ min}^{-1}}{600 \text{ min}^{-1}} = 2.42$$

Effective output speed and transmission

$$n_{2\text{eff}} = n_1 \cdot \frac{1}{i_{\text{eff}}} = n_1 \cdot \frac{z_1}{z_2} \quad [\text{min}^{-1}] \quad \text{with } n_1 \text{ [min}^{-1}\text{]} \text{ and } i_{\text{eff}} \text{ [-]} \quad i_{\text{eff}} = \frac{z_2}{z_1} \quad [-] \quad \text{with } z_1 \text{ [-]} \text{ and } z_2 \text{ [-]}$$

$$n_{2\text{eff}} = 1450 \text{ min}^{-1} \cdot \frac{25}{60} = 604.16 \text{ min}^{-1} \quad i_{\text{eff}} = \frac{60}{25} = 2.4$$

For the output, a timing belt pulley without flanges with a number of teeth of $z = 60$ and an effective diameter $d_w = 190.98 \text{ mm}$ is selected. The prerequisite for the overall height $< 300 \text{ mm}$ is hence met.

The timing belt must be protected on both sides against off-track running from at least one timing belt pulley.

For drive centre distances $a > 8 d_w$, all timing belt pulleys must be equipped with flanges.

For a quick 'ball park' profile performance figure, go to the timing belt and pulley width calculation below.

Effective length

With the aid of the effective diameter d_{wg} and d_{wk} of the determined timing belt pulleys and the intended drive centre distance a , the theoretical effective length of the timing belt is determined. Using this, the closest standard effective length L_{wst} of the selected product group and the profile, here AT10, is determined.

$$L_{\text{wth}} = 2 \cdot a + \frac{\pi}{2} \cdot (d_{wg} + d_{wk}) + \frac{(d_{wg} - d_{wk})^2}{4a} \quad [\text{mm}] \quad \text{with } a \text{ [mm]}, d_{wg} \text{ [mm]} \text{ and } d_{wk} \text{ [mm]}$$

$$L_{\text{wth}} = 2 \cdot 410 \text{ mm} + \frac{\pi}{2} \cdot (190.98 \text{ mm} + 79.58 \text{ mm}) + \frac{(190.98 \text{ mm} - 79.58 \text{ mm})^2}{4 \cdot 410 \text{ mm}}$$

$$L_{\text{wth}} = 1252.60 \text{ mm} \quad \text{selected } L_{\text{wst}} = 1250 \text{ mm}$$

from Optibelt product range: Product group optibelt ALPHA TORQUE for AT10 profile

3 POWER DRIVES

3.5 DRIVE DESIGN



Drive centre distance

Based on the selected standard length and the pulley diameters, the exact drive centre distance a_{nom} of the drive can be derived. This must be within the specified tolerance limits of 390 mm to 430 mm. The allowances for fitting y and tensioning x must be included, if required, see figure with further details in the last profile of this subchapter.

$$a_{nom} = K + \sqrt{K^2 - \frac{(d_{wg} - d_{wk})^2}{8}} \quad [\text{mm}] \quad \text{with } K \text{ [mm], } d_{wg} \text{ [mm] and } d_{wk} \text{ [mm]}$$

$$a_{nom} = 206.25 \text{ mm} + \sqrt{206.25^2 \text{ mm}^2 - \frac{(190.98 \text{ mm} - 79.58 \text{ mm})^2}{8}} = 408.71 \text{ mm}$$

$$\text{with } K = \frac{L_{wSt}}{4} - \frac{\pi}{8} (d_{wg} + d_{wk}) \quad [\text{mm}] \quad \text{with } L_{wSt} \text{ [mm], } d_{wg} \text{ [mm] and } d_{wk} \text{ [mm]}$$

$$K = \frac{1250 \text{ mm}}{4} - \frac{\pi}{8} (190.98 \text{ mm} + 79.58 \text{ mm}) = 206.25 \text{ mm}$$

Recommended drive centre distances and collision check

A simplified recommendation, related to small drive centre distances with a given pulley diameter is:

$$0,7 \cdot (d_{wg} + d_{wk}) < a \quad [\text{mm}] \quad \text{with } d_{wg} \text{ [mm] and } d_{wk} \text{ [mm]}$$

$$0,7 \cdot (190.98 \text{ mm} + 79.58 \text{ mm}) = 189.4 \text{ mm} \quad \text{This condition is fulfilled with } a = a_{nom} = 408.71 \text{ mm.}$$

It has to be noted in general that with decreasing free span lengths and in proportion to the belt lengths that are in contact with the timing belt pulleys the requirements for the accuracy of all components and the installation grow. In addition, large pulley diameters are usually more expensive than wider, smaller pulley diameters.

Under restricted space conditions, a diameter smaller than the above recommendation can be selected. In this case, a collision check is necessary, with the drive centre distance a_{col} , where the pulleys collide, being dependant on the respective flange arrangements. The pulleys of a drive must not touch each other when they are slid on the shafts. In addition, it should be possible, when fitting the belt, to shift the shaft of a pulley to an extent that an unconstrained belt installation over the flanges is possible, see Figure 3.5.3.

$$a_{col} < a_{nom} \quad \text{with } a_{nom} \text{ [mm]}$$

The fitting distance y is also addressed in the last chapter of this subchapter. For the flange arrangement, the following can be derived usually and in this case:

$$a_{col} = 0.5 \cdot (D_{Bk} + d_{wg}) + y \quad [\text{mm}] \quad \text{with } D_{Bk} \text{ [mm], } d_{wg} \text{ [mm] and } y \text{ [mm], also see Chapter 7.5}$$

$$a_{col} = 0.5 \cdot (83 + 190.98) + 10 = 147 \text{ mm} \quad \text{This is met as above with } a = a_{nom} = 408.71 \text{ mm.}$$

In the case of a deviating flange arrangement, this formula has to be adjusted accordingly.

If the shifting distance for fitting the belt is likewise undercut, the installation of the pulleys on the shafts can be made together with the already fitted belt.

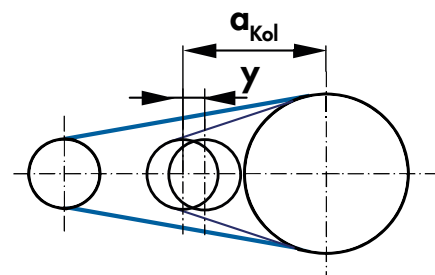

Figure 3.5.3: Collision check for restricted space

3 POWER DRIVES

3.5 DRIVE DESIGN



For a fixed drive centre distance without tensioner, the negative length tolerance a_{Ltol-} determined under measuring load must be noted, see also Subchapter 7.4. This should then usually be restricted. It is basically recommended to agree a corresponding special length tolerance at a fix drive centre distance.

$$a_{col} = 0.5 \cdot (D_{Bk} + d_{wg}) + a_{Ltol-} \quad [\text{mm}] \quad \text{with } D_{Bk} [\text{mm}], d_{wg} [\text{mm}] \text{ and } y [\text{mm}], \text{ see also Chapter 7.4}$$

In the case of a deviating flange arrangement, this formula has to be adjusted accordingly. Even more precise is the use of the smaller outside diameter d_a instead of the effective diameter d_w , which is used for simplification.

Related to the large drive centre distances, Figure 3.5.4 shows two drives with identical drive centre distances and transmission ratio, however, with pulley diameters that are smaller by a factor of 3. The drive with the large pulleys exhibits relatively large contact lengths in proportion to the drive centre distance in the example below:

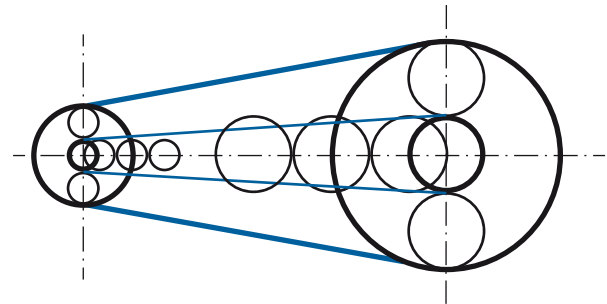

Figure 3.5.4: Pulley diameter with identical drive centre distance

$$a < 2 \cdot (d_{wg} + d_{wk}) \quad [\text{mm}] \quad \text{with } d_{wg} [\text{mm}] \text{ and } d_{wk} [\text{mm}]$$

E.g. the following dimensions conform to the above formula:

$$2 \cdot (190.98 \text{ mm} + 79.58 \text{ mm}) = 541 \text{ mm} \quad \text{This recommendation is met with } a = a_{nom} = 408.71 \text{ mm.}$$

The probability for a trouble-free, relatively smooth run of the span sides is accordingly high.

In contrast, the drive with the smaller pulleys in Figure 3.5.4 exhibits rather small contact lengths in comparison and guides the free span lengths between the pulleys consequently less safely. As can be seen between the small pulleys represented between the pulleys, this drive does not meet the recommendation. The drive centre distance reaches approx. $3.3 \cdot (d_{wg} + d_{wk})$.

However, in a smooth run or with only occasional impact loads, this drive may also function without rapping span sides. However, in general the probability rises here that the span sides rap and the drive consequently will not reach a satisfying service life.

Reliable statements about the vibration behaviour of the span sides, however, are only possible for any drive geometry, also within the recommendation, by verification in a test.

Timing belt and pulley width

For the calculation of the nominal power, the calculation tooth number z_{eB} has to consider both the engaged teeth of the small pulley z_e and the total number of pulley teeth z_k . See Table 2.1.2 for the maximum permissible calculation tooth number z_{eBmax} .

$$z_{eB} = z_e \text{ and } z_{eB} \leq z_{eBmax} \quad \text{with } z_{eBmax} = 12 \text{ for optibelt ALPHA TORQUE / POWER, ALPHA FLEX}$$

$$z_e = \frac{z_k}{6} \left(3 - \frac{d_{wg} - d_{wk}}{a_{nom}} \right) \quad [-]$$

$$z_e = \frac{25}{6} \left(3 - \frac{190.98 \text{ mm} - 79.58 \text{ mm}}{408.71 \text{ mm}} \right) = 11.36 \quad z_{eB} = z_e = 11$$

3 POWER DRIVES

3.5 DRIVE DESIGN



The theoretically required timing belt width b_{th} is calculated, among other factors, of the design power P_B , the specific rated power $P_{N\ spec}$, interpolated from the associated Technical Data Sheet and the length factor c_3 from Table 2.2.3.

$$b_{th} = \frac{P_B \cdot 10^3}{P_{N\ spec} \cdot z_k \cdot z_{dB} \cdot c_3} \quad [\text{mm}] \quad \text{with } P_B \text{ [kW], } P_{N\ spec} \text{ [W/mm], } z \text{ [-] and } c_3 \text{ [-]}$$

$$b_{th} = \frac{13.5 \text{ kW} \cdot 10^3}{1.082 \frac{\text{W}}{\text{mm}} \cdot 25 \cdot 11 \cdot 1.0} = 45.4 \text{ mm selected } b_{St} = 50 \text{ mm}$$

If the required width b_{th} is slightly higher than the next smaller standard width b_{St} , a reduction of the selected total drive service factor c_2 to a still acceptable smaller value has to be checked. This helps to avoid unnecessary costs, if applicable.

As an alternative, the required width – as far as this is permitted by e.g. the installation space – can be reduced by an increased pulley diameter.

The existing safety $c_{2\ actual}$ is:

$$c_{2\ actual} = c_2 \frac{b_{St}}{b_{th}} \quad c_{2\ actual} = 3 \frac{50 \text{ mm}}{45.4 \text{ mm}} = 3.3$$

If the existing safety factor for an optibelt ALPHA TORQUE timing belt is not sufficient, a substitution could be made to the product group optibelt ALPHA POWER.

Static belt tension and circumferential force

The formula for the static belt tension from the circumferential force F_U and the belt tension factor c_v , which usually has the value 1.0, can be taken from Table 2.1.7 in Chapter 2.1 for power drives.

Due to the high selected and existing base drive service factor, the static belt tension F_T can be increased here by the belt tension factor c_v . Additionally, for the drive service factor c_2 the slightly higher existing drive service factor $c_{2\ actual}$ is used in the formula.

Particularly in power drives with long optibelt ALPHA FLEX timing belts, a raising of the static belt tension may be required depending on the uniformity or non-uniformity of the run, e.g. of the driven machine.

The static belt tension F_T basically depends on the circumferential force F_U to be transmitted.

$$F_T = 0.55 \cdot c_v \cdot F_U \quad [\text{N}] \quad \text{with } c_v \text{ [-] and } F_U \text{ [N]} \quad c_v = \frac{c_{2\ actual} - 1}{10} + 1 \text{ [-]} \quad \text{with } c_{2\ actual} \text{ [-]}$$

$$F_T = 0.55 \cdot 1.23 \cdot 745 \text{ N} = 504 \text{ N} \quad c_v = \frac{3.3 - 1}{10} + 1 = 1.23$$

The circumferential force F_U to be transmitted is calculated from the power P , here the rated power P_N , and the effective circumferential speed v_{eff} or the drive speed n_1 and the effective diameter d_{w1} of the driving pulley.

$$F_U = \frac{P \cdot 1000}{v_{eff}} \quad [\text{N}] \quad \text{with } P \text{ [kW] here } P = P_N \quad v_{eff} = \frac{d_{w1} \cdot n_1}{19.1 \cdot 10^3} \left[\frac{\text{m}}{\text{s}} \right] \quad \text{with } d_w \text{ [mm] and } n \text{ [min}^{-1}\text{]}$$

$$F_U = \frac{4.5 \text{ kW} \cdot 1000}{6.04 \frac{\text{m}}{\text{s}}} = 745 \text{ N} \quad v_{eff} = \frac{79.58 \text{ mm} \cdot 1450 \text{ min}^{-1}}{19100} = 60.4 \frac{\text{m}}{\text{s}}$$

3 POWER DRIVES

3.5 DRIVE DESIGN



Static shaft loading

The static shaft loading F_a results from the double acting static belt tension F_T . With a speed ratio $i \neq 1$, the static shaft loading is reduced with decreasing drive centre distance and generally with a rising speed ratio.

$$F_a = 2 \cdot F_T \quad [\text{N}] \quad \text{for } i = 1 \text{ with } F_T \text{ [N]}$$

$$F_a = 2 \cdot 504 \text{ N} = 1008 \text{ N}$$

$$F_a = 2 \cdot F_T \cdot \frac{L}{a_{\text{nom}}} \quad [\text{N}] \quad \text{for } i \neq 1 \text{ with } F_T \text{ [N] and } a_{\text{nom}} \text{ [mm]}$$

$$F_a = 2 \cdot 504 \text{ N} \cdot \frac{401 \text{ mm}}{408.71 \text{ mm}} = 989 \text{ N}$$

The span length L results from the drive geometry. The larger the diameter difference of the pulleys, the smaller the span length L with a constant drive centre distance.

$$L = a_{\text{nom}} \quad [\text{mm}] \quad \text{for } i = 1$$

$$L = a_{\text{nom}} = 408.71 \text{ mm, see above}$$

$$L = \sqrt{a_{\text{nom}}^2 - \frac{(d_{\text{wg}} - d_{\text{wk}})^2}{4}} \quad [\text{mm}] \quad \text{for } i \neq 1$$

$$\text{with } a_{\text{nom}} \text{ [mm] and } d_w \text{ [mm], see above}$$

$$L = \sqrt{408.71^2 \text{ mm}^2 - \frac{(190.98 \text{ mm} - 79.58 \text{ mm})^2}{4}} = 401 \text{ mm}$$

The results of the precise calculation for $i \neq 1$ show that with medium speed ratios for a rough determination of the static shaft loading F_a the calculation method $i = 1$ is sufficient.

Order example

Timing belt and timing belt pulley designations

1 pc. optibelt ALPHA TORQUE 50 AT10/1250-ST

1 pc. optibelt ZRS 66 AT10/25-2

1 pc. optibelt ZRS 66 AT10/60-0

Depending on the shaft/hub connection of the timing belt pulleys these can also be ordered as special pulleys.

Belt tension adjustment through frequency measurement

The specification for the adjustment of the static belt tension F_T through frequency measurement can be calculated depending on the freely oscillating span length L and the weight per metre m_k of the selected belt. The weight per metre m_k can be seen in the relevant Technical Data Sheet.

Further information about frequency measurement is included in Chapter 7.1.

Figure 3.5.5 shows that with the same static belt tension F_T and the same span lengths L the respective natural frequency f of both span sides is equal.

Further information about frequency measurement is included in Chapter 7.1.

$$f = \sqrt{\frac{F_T \cdot 10^6}{4 \cdot m_k \cdot L^2}} \quad [\text{Hz}]$$

with F_T [N], m_k [kg/m] or [g/m] and L [mm]

$$f = \sqrt{\frac{504 \text{ N} \cdot 10^6}{4 \cdot 0.325 \frac{\text{kg}}{\text{m}} \cdot 401^2 \text{ mm}^2}} = 49.1 \text{ Hz}$$

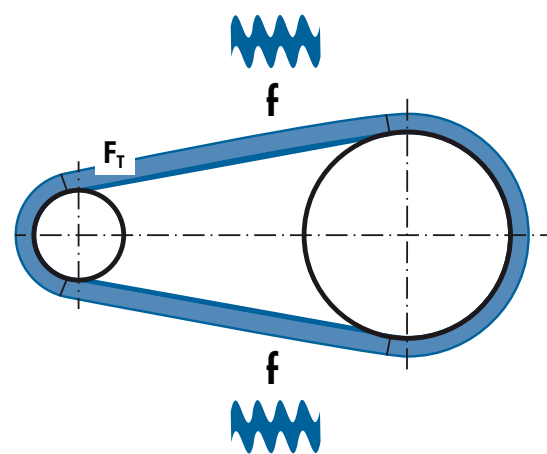

Figure 3.5.5: Static belt tension F_T , span lengths L and frequencies f

3 POWER DRIVES

3.5 DRIVE DESIGN



The result confirms the general recommendation of Table 7.1.2, according to which span lengths under 1000 mm are usually adjusted by frequency measurement.

Belt tension adjustment through measurement of the elongation

For large belt lengths, an optibelt ALPHA FLEX timing belt allows span lengths larger than 1000 mm. If no belt tension adjustment through frequency measurement is possible, the belt tension adjustment through the measurement of the elongation is recommended. This does generally not achieve the accuracy of the belt tension adjustment through the measurement of the natural frequency of a freely oscillating span side. The belt tension adjustment through the measurement of the elongation is described in Chapter 7.1.

The generally applicable, maximum guide value for the static span elongation ε_{FT} of power drives is:

Guide value $\varepsilon_{FT} \leq 0.2\%$

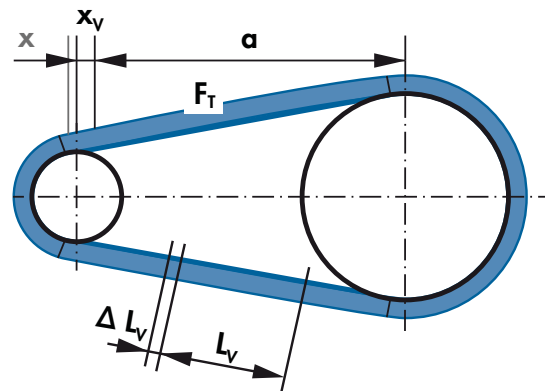

Figure 3.5.6: Belt tension length x_v and elongation ΔL_v

With an assumed drive centre distance $a = 1000$ mm, the unloaded shaft can be moved for tensioning by the tension length $x_v \leq 2$ mm, e.g. 1.3 mm, see Figure 3.5.6.

$$x_v \leq \varepsilon_{FT} \cdot L_v \quad [\text{mm}] \quad \text{with } \varepsilon_{FT} [\%], a [\text{mm}] \quad \text{here e.g. } x_v \leq 0.002 \cdot 1000 \text{ mm} = 2.0 \text{ mm}$$

Similarly, for a marked length of e.g. $L_v = 2000$ mm, the following applies for the precise elongation ΔL_v :

$$\Delta L_v \leq \varepsilon_{FT} \cdot L_v \quad [\text{mm}] \quad \text{with } \varepsilon_{FT} [\%], L_v [\text{mm}] \quad \text{here e.g. } \Delta L_v \leq 0.002 \cdot 2000 \text{ mm} = 4.0 \text{ mm}$$

In practice, a clearly lower value of e.g. $\Delta L_v = 2.6$ mm would be sufficient in most cases to protect bearings and shafts, since timing belts have usually been designed with a drive service factor of at least $c_2 = 1.6$ and higher.

Precise elongation values ε_{FT} can be determined through the static belt tension F_T of the drive and the specific spring rate c_{spec} depending on product group, profile, technical design and width.

$$\varepsilon_{FT} = \frac{F_T}{c_{\text{spec}}} = \frac{F_T}{F_{\text{allowed}}} \cdot \varepsilon_{\text{allowed}} \quad [\%] \quad \text{with } F_T [\text{N}] \text{ and } c_{\text{spec}} [\text{N}]$$

$$\text{with } c_{\text{spec}} = \frac{F_{\text{allowed}}}{\varepsilon_{FT}} \quad [\text{N}] \quad \text{with } F_{\text{allowed}} [\text{N}] \text{ from the Technical Data Sheet and } \varepsilon_{\text{allowed}} [\%], \text{ see Table 4.5.1}$$

The more precise value for the permissible elongation $\varepsilon_{\text{allowed}}$ is indicated in Table 4.5.1 and the relevant profile in the standard cord design ST of an optibelt ALPHA LINEAR timing belt, which can be used here. For simplification, all profiles and designs can be calculated with $\varepsilon_{\text{allowed}} = 0.5\%$.

The permissible circumferential forces F_{allowed} are listed, depending on the width, in the relevant Technical Data Sheet, e.g. optibelt ALPHA FLEX timing belts. An application example is described in Subchapter 4.5 for linear drives.

3 POWER DRIVES

3.5 DRIVE DESIGN



Allowances for tensioning and fitting

Subchapters 7.1 and 7.5 give general information about the allowances. In Tables 7.5.1 and 7.5.2, formula relations and supplementary guide values about the minimum allowances are listed. The allowance x of one individual shaft for tensioning of optibelt ALPHA TORQUE/POWER can be determined in a simplified manner, see Table 7.5.1:

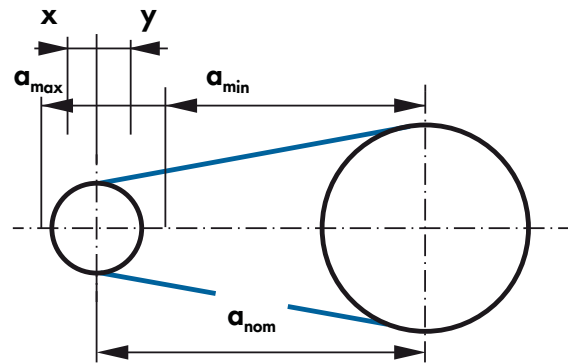

Figure 3.5.7: Allowances x for tensioning and y for fitting

$$x = a_{Ltol} + 0.0030 \cdot a_{nom} \quad [\text{mm}]$$

with a_{Ltol} [mm] from Table 7.4.3 and a_{nom} [mm]

$$x = 0.32 \text{ mm} + 0.0030 \cdot 408.71 \text{ mm} = 1.54 \text{ mm}$$

The allowance y for the fitting of optibelt ALPHA TORQUE/POWER timing belts can likewise be seen in Table 7.5.1:

$$y = 10 \text{ mm}$$

The corresponding information about optibelt ALPHA FLEX timing belts is listed in Table 7.5.2.

The specified range for the intended drive centre distance of a_{min} to a_{max} , see Figure 3.5.7, must be aligned with the determined nominal drive centre distance a_{nom} and the allowances $a_{n min}$ and $a_{n max}$.

$$a_{n min} = a_{nom} - y \quad [\text{mm}] \quad \text{with } a_{nom} [\text{mm}], y [\text{mm}]$$

$$a_{n max} = a_{nom} + x \quad [\text{mm}] \quad \text{with } a_{nom} [\text{mm}], x [\text{mm}]$$

$$a_{n min} = 408.71 \text{ mm} - 10 \text{ mm} = 398.71 \text{ mm} > 390 \text{ mm}$$

$$a_{n max} = 408.71 + 1.54 = 410.25 \text{ mm} < 430 \text{ mm}$$

If in contrast to the calculation example, one of the specifications for a_{min} or a_{max} cannot be met, a suitable solution can be found in the Optibelt product range, if applicable, by a different length or different numbers of teeth of the pulleys. As an alternative, special pulleys with different numbers of teeth can also be delivered, where the smaller pulley should always be designed as a special pulley for cost reasons.

If required, special lengths in the product groups ALPHA TORQUE/POWER timing belts can likewise be offered, depending on the selected length. For large quantities, it may be more cost effective to have your own casting die.

For lengths from 1000 mm, optibelt ALPHA FLEX timing belts can be offered in pitch steps, see Subchapter 3.1. If more precise allowances have to be determined, the formula connections of the previous chapter can be used, taking the relevant length tolerances into account.

The relevant chapters about linear and transport drives contain formulas and examples.

3 POWER DRIVES

3.6 TECHNICAL DATA SHEET



3.6 Technical Data Sheet

Power drives can be designed with the information in the Technical Data Sheets of the product groups optibelt ALPHA TORQUE, ALPHA POWER and ALPHA FLEX timing belts, further data in this Technical Manual and the current Optibelt product range list. In Subchapter 3.5, this is done generally and uses an optibelt ALPHA TORQUE timing belt with the AT10 profile of the ST standard design.

The relevant up-to-date Technical Data Sheets are available on the website www.optibelt.com. There, you can download the optibelt CAP software for drive design of power drives free of charge and obtain further current information about services and products.

Technical Data Sheet

optibelt ALPHA TORQUE AT10 - ST

PU Timing Belt, Cast Polyurethane, Endless



Dimensions, Tolerances

Profile:	AT10
Tooth pitch t:	10 mm
Total thickness:	5 mm
Tooth height:	2.5 mm
Tooth tip width:	5 mm
Tooth flank angle:	50°
Length tolerance:	See table
Width tolerance, b ≤ 50 mm:	± 0.5 mm
Thickness tolerance:	± 0.3 mm

Construction

Polyurethane:	Thermoset, 84 +/-4 Shore A, transparent
Tension cord:	Steel, Ø 0.9 mm

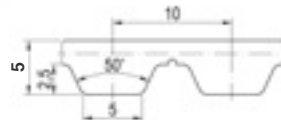

Specific nominal power transmittable per tooth

Speed, small pulley n _k [1/min]	Specific nom. power P _{N spez} [W/mm]	Speed, small pulley n _k [1/min]	Specific nom. power P _{N spez} [W/mm]	Speed, small pulley n _k [1/min]	Specific nom. power P _{N spez} [W/mm]
0 ¹	0.000	1200	0.947	3600	1.898
20	0.025	1300	1.002	3800	1.952
40 ²	0.048	1400	1.056	4000	2.003
60	0.072	1500	1.108	4500	2.119
80 ³	0.094	1600 ⁷	1.158	5000	2.220
100	0.116	1700	1.207	5500	2.308
200 ⁴	0.220	1800	1.253	6000	2.383
300	0.314	1900	1.299	6500	2.447
400 ⁵	0.401	2000	1.343	7000	2.500
500	0.482	2200	1.427	7500	2.545
600	0.559	2400	1.506	8000	2.580
700	0.631	2600	1.581	8500	2.606
800 ⁶	0.700	2800	1.652	9000	2.625
900	0.766	3000	1.718	9500	2.636
1000	0.828	3200 ⁸	1.782	10000	2.640
1100	0.889	3400	1.842	v _{max} = 60 m/s	

¹F_{N spez} [N/mm] 7.500 ²7.273 ³7.073 ⁴6.590 ⁵6.012 ⁶5.250 ⁷4.343 ⁸3.341

Nominal power P_N

$$P_N = P_{N\ spez} \cdot Z_k \cdot Z_{eB} \cdot b / 10^3 \quad [\text{kW}]$$

P _{N spez}	Specific nominal power transmittable per tooth [W/mm]
Z _k	Number of teeth, small pulley
Z _{eB}	Number of teeth in mesh, small pulley, limited to Z _{eB max}
Z _{eB max}	12, maximum allowable no. of teeth
b	Belt width [mm]

Nominal torque M_N

$$M_N = P_N \cdot 9.55 \cdot 10^3 / n_k \quad [\text{Nm}]$$

n _k	Speed, small pulley [1/min]
----------------	-----------------------------

Nominal tensile force F_N

$$F_N = F_{N\ spez} \cdot Z_{eB} \cdot b \quad [\text{N}]$$

$$F_{N\ spez} = P_{N\ spez} \cdot 6 \cdot 10^4 / (n_k \cdot t) \quad [\text{N/mm}]$$

F _{N spez}	Specific nominal tensile force transmittable per tooth [N/mm]
t	Tooth pitch [mm]

Cord tensile forces, belt weight

Belt width ¹ b [mm]	10	12	16	20	25	32	50	75	100
Breaking strength F _{Br} [N]	4760	5700	8560	10500	14300	18100	29500	45600	62000
Allowable tensile force ² F _{Zul} [N]	1190	1425	2140	2625	3575	4525	7375	11400	15500
Weight per metre [kg/m]	0.065	0.078	0.104	0.130	0.163	0.208	0.325	0.488	0.650

¹ Other and intermediate widths possible ² Allowable tensile force F_{Zul} equivalent to 25% breaking strength F_{Br} of the cords

Timing belt pulleys, inside and outside idlers



No. of teeth: z _{min}	= 15
Pitch-Ø: d _{w min}	= 47.75 mm
Plane, cylindrical idlers, Ø	
Inside idler: d _{min}	= 42 mm
Outside idler: d _{min}	= 100 mm

Length tolerances, shown as centre distance tolerances

Length L _w [mm]	Tolerance a _{L Tol} [mm]	Length L _w [mm]	Tolerance a _{L Tol} [mm]
≤ 305	± 0.14	> 780 ≤ 990	± 0.28
> 305 ≤ 390	± 0.16	> 990 ≤ 1250	± 0.32
> 390 ≤ 525	± 0.18	> 1250 ≤ 1560	± 0.38
> 525 ≤ 630	± 0.21	> 1560 ≤ 1960	± 0.44
> 630 ≤ 780	± 0.24	> 1960 ≤ 2350	± 0.52

We would be pleased to offer advice about technical characteristics and drive design as well as special requirements. Further information can be found in OPTIBELT documentation. © OPTIBELT GmbH 09/2015. Subject to technical modification and change, errors and omissions excepted.

4 LINEAR DRIVES

4.1 GENERAL



4.1 General

Chapters 1.1 to 1.3 contain, for example, the applications, characteristics, production processes and structures of all product groups of the polyurethane timing belts. These are summarised in this chapter for linear drives and the pertaining product group optibelt ALPHA LINEAR.

The product group optibelt ALPHA LINEAR includes an elastomer of 92 Shore A hard polyurethane in its standard version and is consequently able to reliably transmit the power without an additional fabric layer on the tooth side – see Figure 4.1.1. The optibelt ALPHA LINEAR timing belt can optionally be provided with a thin fabric on the tooth side for friction or noise minimisation, see Figure 4.1.2. Fabric on the top surface is likewise possible. Compared to the open-ended timing belts of rubber with a glass fibre tension cord, the optibelt ALPHA LINEAR timing belt is basically more stable in shape and more accurate in positioning.

The basic features or benefits of the timing belts of polyurethane are:

- High-strength steel or aramid tension cord
- Low tooth deformation
- High abrasive strength
- Large lengths can be implemented
- High ozone and UV resistance
- Good to very good resistance to oils, greases and a large number of aggressive chemicals
- Optional PU with EU Declaration of Compliance / FDA, see www.optibelt.com

The product group optibelt ALPHA LINEAR extends the application spectrum to drives with very long drive centre distances:

- Standard length on rolls for pitch smaller than 14 mm: 100 m
- Standard length on rolls for pitch from 14 mm: 50 m
- Clearly larger lengths than standard length possible on reel, e.g. 300 m in 8M profile and width 10 mm

Simple open-ended optibelt ALPHA LINEAR timing belts are used in linear drives with a high positioning and repetition accuracy.

The major single influencing factors for the total repetition and positioning accuracy are:

- Tension cord elongation
- Tooth deformation
- Tooth gap clearance

Further influencing factors are e.g. the length variations of the belt, the precision of shafts and pulleys, the overall rigidity and the bearing clearances of the linear unit.

Table 4.1.1: Product group and applications

Linear drives

optibelt ALPHA LINEAR
open-ended
Application examples
Positioning devices Lifting drives Handling devices Door and gate drives Wash stations Plotters Packaging machines Portal robots

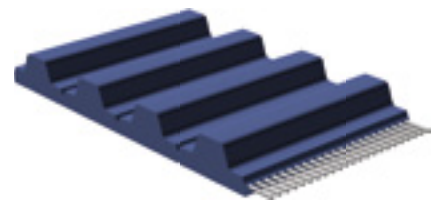

Figure 4.1.1: optibelt ALPHA LINEAR

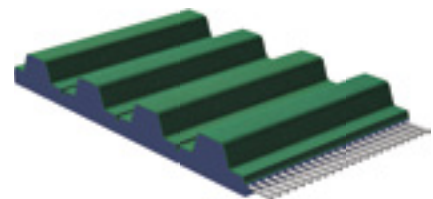

Figure 4.1.2: optibelt ALPHA LINEAR with polyamide fabric PAZ on the tooth side

4 LINEAR DRIVES

4.1 GENERAL



The use of high-strength steel or aramid tension cords with a low elasticity in combination with bending flexibility keeps the major portion of the overall deviation low.

Timing belts with the ATL profile for AT pulleys with standard tooth system are equipped with tension cords that are especially reinforced for the linear technology and a negative length tolerance. This combination enables an even more rigid timing belt system with an above-average positioning accuracy compared to timing belts in technical standard design.

The abrasion-resistant polyurethane with an already high standard hardness of 92 Shore A features a high stability in shape that decreases with a lower hardness and increases with a higher hardness. If applied as a tooth bar, the special hardness 98 Shore A can be used, which is not suitable for the circulation of the timing belt pulleys.

Timing belt pulleys with reduced tooth gaps for a limited tooth gap clearance or even tooth gaps which correspond in size and contour to the belt tooth, also called zero gap, increase the accuracy even further, if required; see also Subchapter 4.6.

The open-ended polyurethane timing belts of the product group ALPHA LINEAR can be provided on the tooth side and/or on the top surface during production with a polyamide fabric to minimise the noise development and reduce the force losses of the supporting span side in the case of long drive centre distances. The features of the PA fabric are described in Subchapter 6.1.

For the linear drives, basically the AT and HTD profiles are used which exhibit a higher shape rigidity than the smaller trapezoidal T profiles or imperial profile.

Open-ended, extruded polyurethane timing belts have the following features:

- High tensile forces with low elongation
- High positioning accuracy
- S+Z tensile reinforcements in parallel to the edges
- Design e.g. with highly flexible and/or reinforced tension cords possible
- Base belt without sleeve nose depending on profile, e.g. profile T10
- PAZ/PAR, polyamide fabric on tooth system and/or belt top surface possible
- Roll length 50 m or 100 m, intermediate lengths available on request

Table 4.1.2: Product groups, lengths, profiles and features

optibelt ALPHA LINEAR extruded, open-ended	
Length of the roll	50 m, 100 m
Intermediate lengths	in indexing steps
Imperial profile	XL, L, H, XH
T profile	T5, T10, T20
AT profile	AT5, AT10, AT20
ATL profile	ATL5, ATL10, ATL20
HTD profile	5M, 8M, S8M, 14M, 14ML, 14MLP
Flat belt	F2, F2.5, F3, FL3
Standard colour	white
Standard hardness	92 Shore A
Standard tension cord ¹	steel aramid
PA tooth side, PAZ	+ optional
PA top surface, PAR	+ optional
Special hardness	65, 85, 98 Shore A
Special colour	e.g. black, blue, on request according to RAL No.
Minimum quantity for special hardness, colour	from 200 metres with max. production width
Special tension cord ¹ see Chapter 1.6	highly flexible steel stainless steel
Without sleeve nose	T10, optional
PU (FDA): Hardness, colour	85 Shore A, blue, optionally transparent

¹ Aramid and special cords for each profile on request



Figure 4.1.3: Extruded and moulded polyurethane with tensile reinforcements parallel to the edges

4 LINEAR DRIVES

4.2 VARIATIONS



4.2 Variations

The main function of linear drives is to convert a rotary movement (rotation) into a straight movement (translation). In this context, two variations are distinguished to move the linear slide:

Linear drive, fixed motor

For linear drives with a fixed motor, the guided linear slide is fixed with the aid of two clamping plates to the timing belt.

The belt tension is produced by adjusting a drive centre or sliding a clamping plate. Backside idlers are not needed in this design so that no varying bending load acts on the belt.

In addition to the output load, basically only the slide is accelerated.

The timing belt ends are preferably fastened by means of clamping plates on the guided slide. The optibelt CP clamping bushings included in the standard product range ensure a safe clamping of the standard timing belts up to the respective breakage limit.

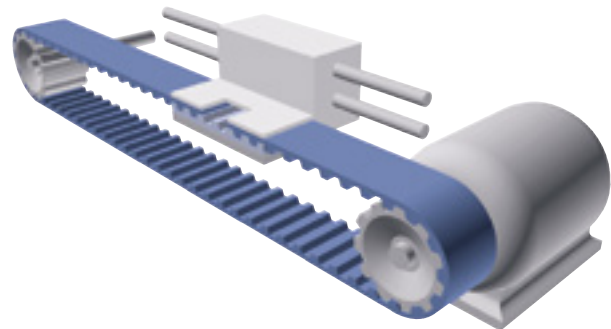

Figure 4.2.1: Linear drive, fixed motor

Due to the lower costs compared to linear drives combined with a larger possible acceleration, this drive variant has proven successful for small and medium linear drives.

Linear drive, moving motor

For linear drives with a moving motor, the guided linear slide is accelerated together with the driving motor. The linear slide is then also called a traveller. This variation of the linear drive is preferably used for very long distances and less widely applied than linear drives with a fixed motor.

The required contact of the timing belt with the drive pulley is ensured by two cylindrical pulleys on the top surface which are supported by the linear slide. For this reason, this variation is also called an Omega drive. The timing belt is subject to a flexible load. The timing belt ends are fixed with one clamping plate each.

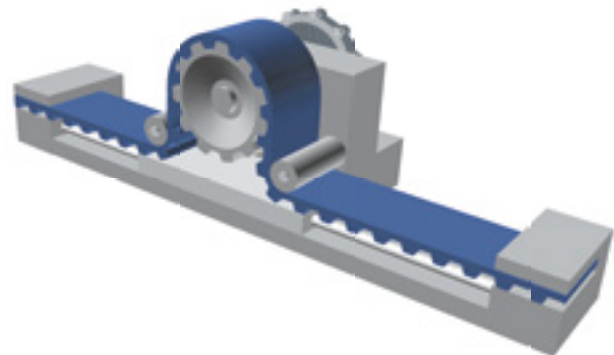

Figure 4.2.2: Linear drive, moving motor

In addition to the output load, the slide must be accelerated together with the comparably heavy motor. Benefits of this design are the safe support of the belt especially for large distances and the minimised length of the long tight side compared to drives with a fixed motor so that an increased rigidity and an improved positioning accuracy under load are possible.

The linear slide can alternatively be stationary so that the otherwise firm frame is moved e.g. in the function of a table.

4 LINEAR DRIVES

4.3 TIMING BELT PRE-SELECTION



4.3 Timing Belt Pre-selection

Selection of tooth system

All available profiles of the product group optibelt ALPHA LINEAR are suitable for application in linear drives. The following overview summarises the basic characteristics of the tooth systems for these profiles

AT profiles

- The AT timing belt exhibits the highest tooth shear strength or the highest permissible specific tooth force of all trapezoidal profiles.
- Due to the low tooth deformation of the AT profile, the comparatively strong cords and the comparatively low backlash, high positioning accuracies are achieved.
- In contrast to the other trapezoidal profiles, the tooth is supported on the tooth head area in the tooth gaps of the tooth system of the pulleys.
- ATL profiles feature even larger tension cord diameters and lower elongation values for the running capability in standard AT timing belts.
- Standard timing belt pulleys of aluminium reduce the moment of mass inertia acting at a constant acceleration.

HTD profiles

- The HTD profile is a round curved profile that features a smoother run in comparison with the trapezoidal tooth and a higher skip protection due to the larger tooth height.
- The profile designation stands for "high torque drive". It was developed for highly loaded drives and is used today in new designs primarily for power drives.
- The HTD profile has a large width at the tooth base and hence exhibits a high shear strength and a high permissible specific tooth force. The belt webs between the teeth rest on the tooth heads of the tooth system of the pulleys.
- The backlash is larger than in AT profiles and consequently reduces the positioning accuracy.
- 14ML profiles feature again larger tension cord diameters and lower elongation values with a running capability in standard 14M timing belt pulleys.
- Standard timing belt pulleys of grey cast iron or steel are more wear-resistant than aluminium pulleys, but increase the moment of mass inertia acting during continuous acceleration.

T profiles

- The most widely used metric T profile has a trapezoidal shape like the imperial profile. In new designs, this profile is selected for drives that are specifically exposed to low loads.
- Due to the smaller tension cord diameters and the smaller teeth compared to the AT and HDT profiles, the belt is more flexible and can be placed on smaller tooth pulley diameters.
- The backlash and the belt elongation are larger than on the AT timing belt of the same pitch.
- The belt web between the teeth is supported on the tooth heads of the tooth system of the pulleys. In e.g. strongly dust-loaded environments, the larger backlash or the larger clearance between belt and pulley can minimize the tendency to run off the pulley as opposed to the AT profile.

Imperial profiles

- Today, the imperial trapezoidal profile is hardly used any more in new designs, particularly in the European area. The characteristics basically correspond to those of the T profiles.

4 LINEAR DRIVES

4.3 TIMING BELT PRE-SELECTION



Pre-selection of profile and width

Depending on the selected tooth system, e.g. the AT profile, the following diagrams then enable an easy pre-selection of suitable profiles with associated belt widths. The indicated values refer to the maximum specified tensile forces of the belt cords.

The rated tensile force F_N , which is likewise crucial for an exact drive design of a timing belt and which can be calculated with the aid of the relevant Technical Data Sheet, refers in contrast to of the cords to the weaker belt tooth system, especially for high speeds.

Diagram 4.3.1: T and imperial profile, permitted tensile forces F_{allowed} depending on profile and width in a simplified representation

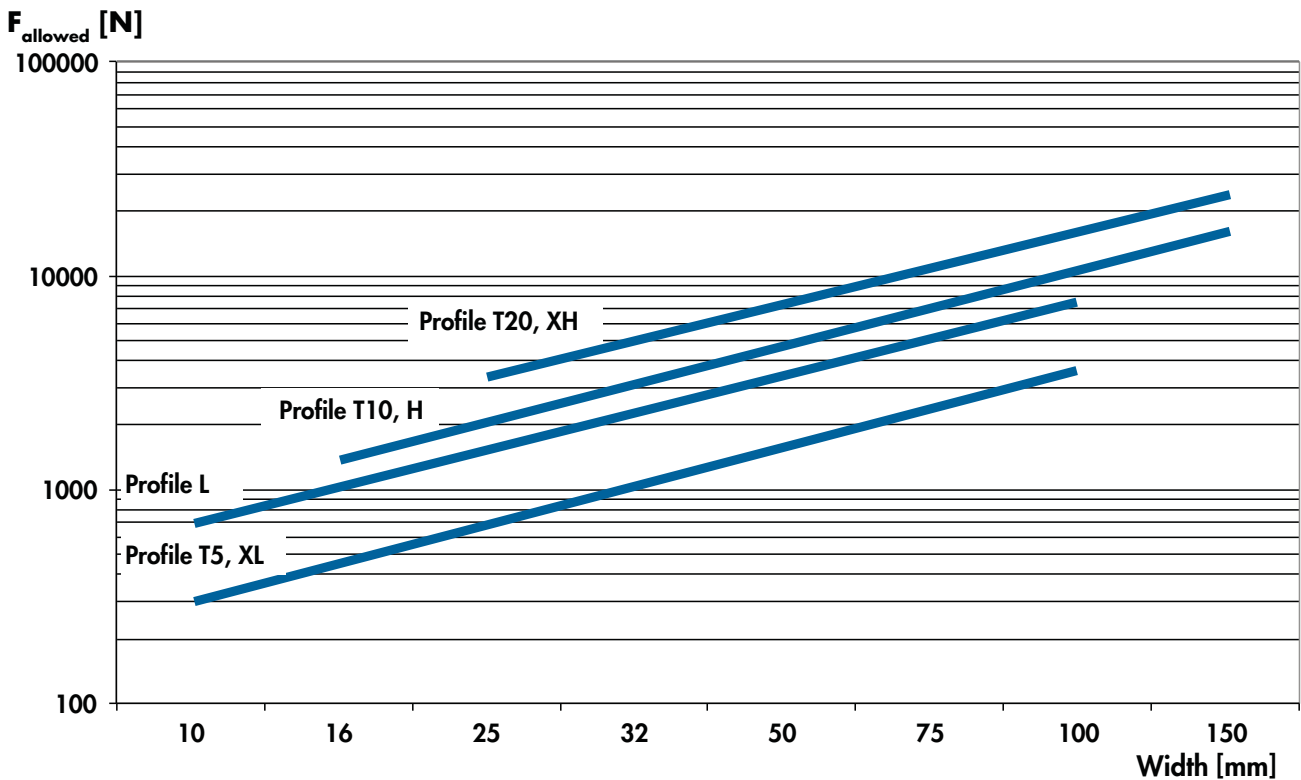

4 LINEAR DRIVES

4.3 TIMING BELT PRE-SELECTION



Diagram 4.3.2: AT and HTD profile, permissible tensile forces F_{allowed} depending on profile and width in a simplified representation

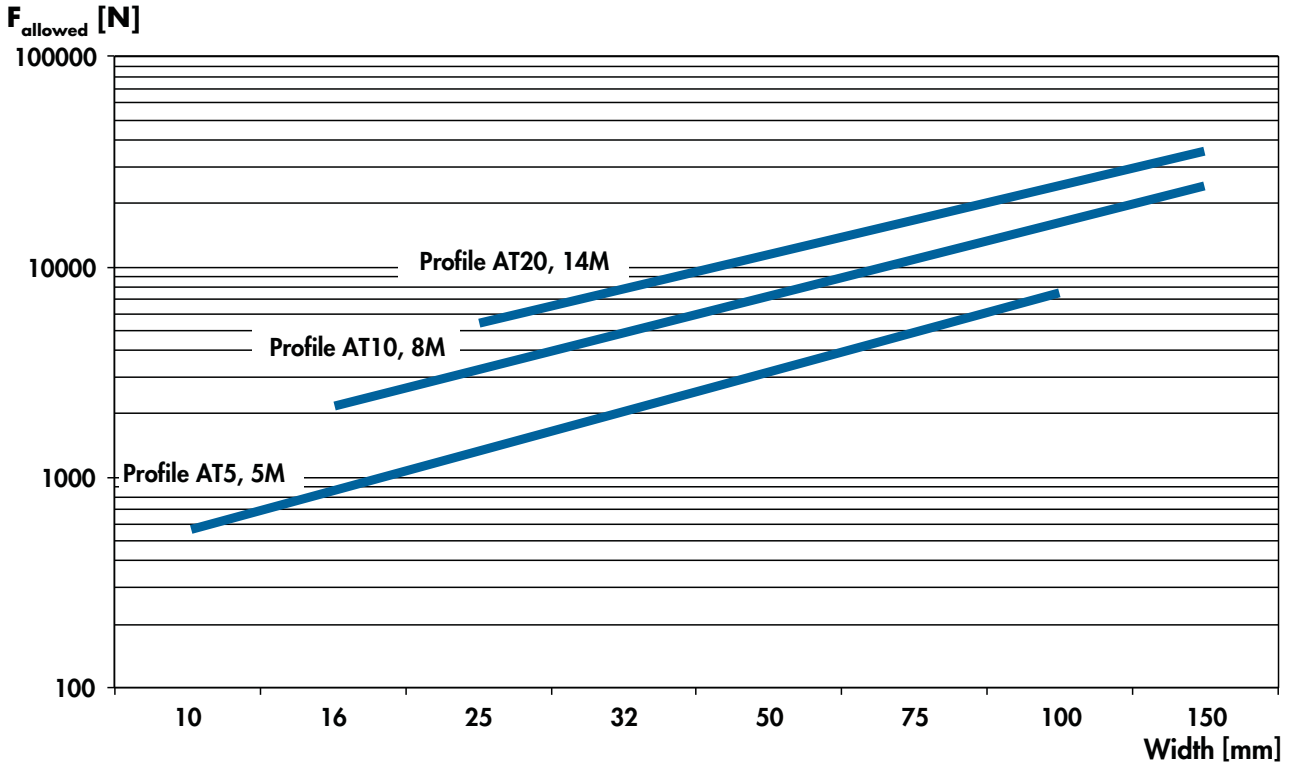
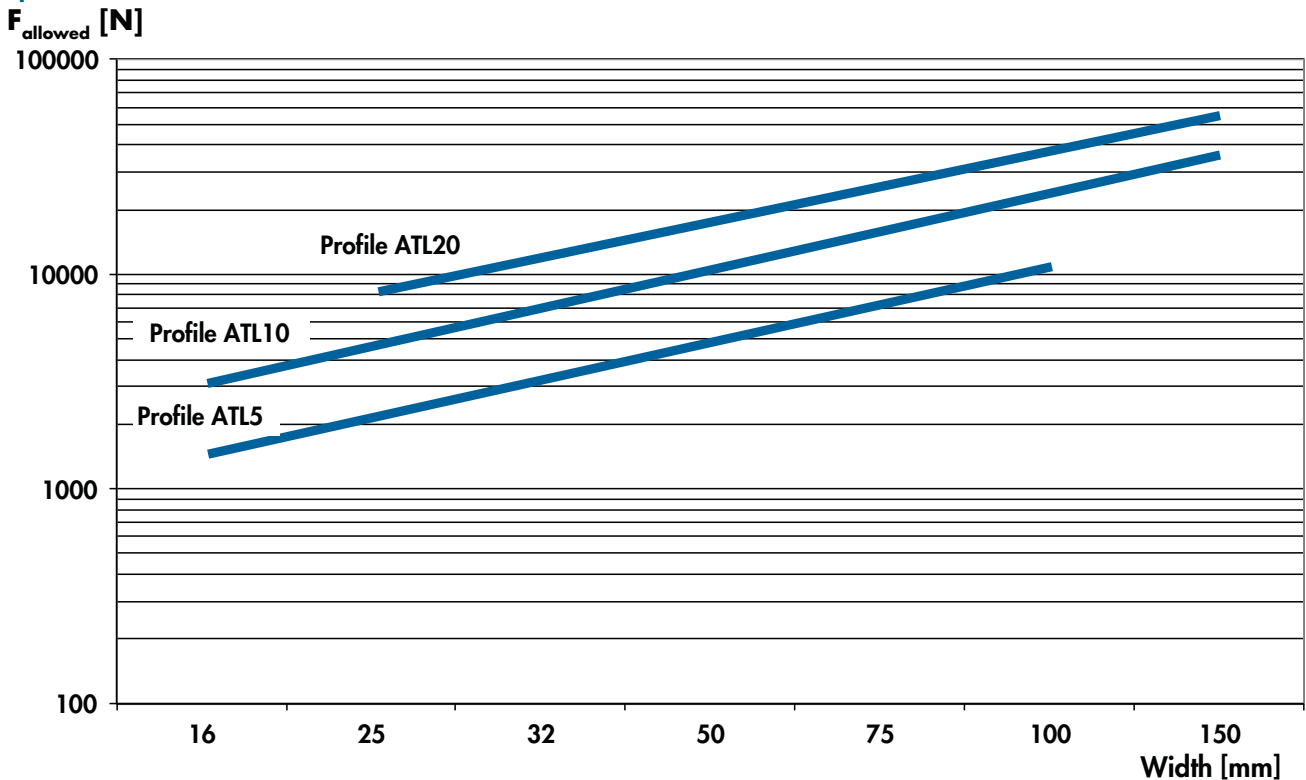

Diagram 4.3.3: ATL profile, permissible tensile forces F_{allowed} depending on profile and width in a simplified representation



4 LINEAR DRIVES

4.4 BASICS FOR DRIVE DESIGN



4.4 Basics for Drive Design

The general formulas to the basic physical variables such as power P, torque M and circumferential force F_U are indicated in Subchapter 2.1. Guide values for drive service factors and allowances are addressed in Subchapter 2.2. The formula symbols are described in Subchapter 2.3 and listed with their physical units.

Accelerations, speeds, distances and times

The largest load on the timing belt occurs during the acceleration and deceleration phase. During the movement at constant speed, the load on the belt is the lowest in the whole movement cycle. Here, the friction forces and depending on the arrangement, downward or lifting forces acting in linear drives are usually very low.

Diagram 4.4.1: Velocities and acceleration diagram

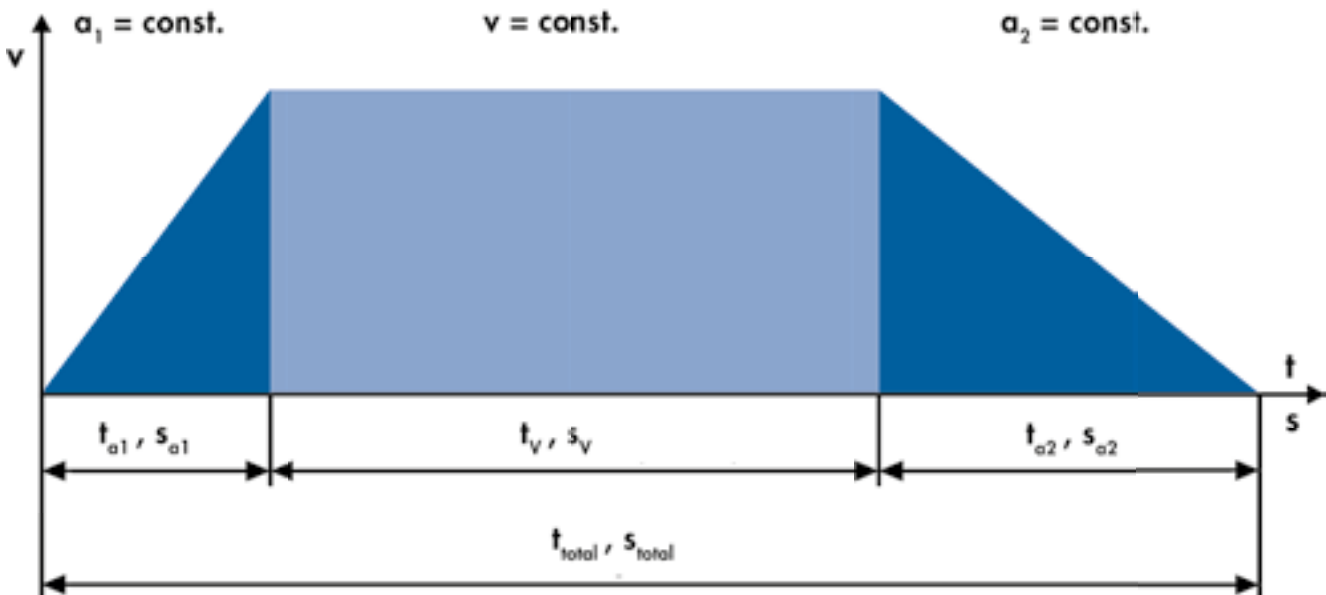

RPM n and velocity v

$$n = \frac{19.1 \cdot 10^3 \cdot v}{d_w} \quad \left[\frac{1}{\text{min}} \right] \quad \text{with } v \left[\frac{\text{m}}{\text{s}} \right], d_w [\text{mm}]$$

$$v = \frac{d_w \cdot n}{19.1 \cdot 10^3} \quad \left[\frac{\text{m}}{\text{s}} \right] \quad \text{with } d_w [\text{mm}], n \left[\frac{1}{\text{min}} \right]$$

$$v = \sqrt{\frac{2 \cdot s_a \cdot a}{10^3}} \quad \left[\frac{\text{m}}{\text{s}} \right] \quad \text{with } s_a [\text{mm}], a \left[\frac{\text{m}}{\text{s}^2} \right]$$

4 LINEAR DRIVES

4.4 BASICS FOR DRIVE DESIGN



Acceleration time t_a depending on acceleration a

$$t_a = \frac{v}{a} \quad [s] \quad \text{with } v \left[\frac{m}{s} \right], a \left[\frac{m}{s^2} \right]$$

$$v = \sqrt{\frac{2 \cdot s_a}{a \cdot 10^3}} \quad \left[\frac{m}{s} \right] \quad \text{with } s_a [mm], a \left[\frac{m}{s^2} \right]$$

Acceleration distance s_a depending on acceleration a

$$s_a = \frac{a \cdot t_a^2 \cdot 10^3}{2} \quad [mm] \quad \text{with } a \left[\frac{m}{s^2} \right], t_a [s]$$

$$s_a = \frac{v^2 \cdot 10^3}{2 \cdot a} \quad [mm] \quad \text{with } a \left[\frac{m}{s^2} \right], v \left[\frac{m}{s} \right]$$

Time of movement t_v at constant velocity v

$$t_v = \frac{s_v}{v \cdot 10^3} \quad [s] \quad \text{with } s_v [mm], v \left[\frac{m}{s} \right]$$

Distance of movement s_v at constant velocity v

$$s_v = v \cdot t_v \cdot 10^3 \quad [mm] \quad \text{with } t_v [s], v \left[\frac{m}{s} \right]$$

Total time t_{total}

$$t_{total} = t_{a1} + t_v + t_{a2} \quad [s] \quad \text{with } t_{a1} [s], t_v [s] \text{ and } t_{a2} [s]$$

Total distance s_{total}

$$s_{total} = s_{a1} + s_v + s_{a2} \quad [mm] \quad \text{with } s_{a1} [mm], s_v [mm], s_{a2} [mm]$$

4 LINEAR DRIVES

4.5 DRIVE DESIGN



4.5 Drive Design

Requirement

In the following calculation example, a mass m is moved back and forth under an angle of inclination α relative to the horizontal line. The downward force and the acceleration counteracting this during the upward movement or the deceleration during the downward movement result in the maximum load on the linear drive.

Depending on the available installation space, the suitable belt and pulley combination can be determined through the maximum load.

The following values are given:

Mass m_1 to be moved = 85 kg

Mass of the linear slide $m_2 = 15$ kg

Acceleration $a_1 = 3$ m/s²

Deceleration $a_2 = 11$ m/s²

Velocity of movement $v = 4$ m/s

Friction coefficient of slide guidance $\mu = 0.1$

Angle of inclination $\alpha = 30^\circ$

Intended drive centre distance $a = 2600$ mm

Distance of movement $s = 2100$ mm

Slide length $L_S = 200$ mm

Installation height: Diameter $d_{max} < 150$ mm, $d_{w1} = d_{w2}$

Installation width: Hub width b_1 and pulley width B unspecified

Shaft diameter d : unspecified

Starts per day in three-shift operation: approx. 300

Ambient conditions: Room temperature, no influence of harmful substances, chemicals and radiation

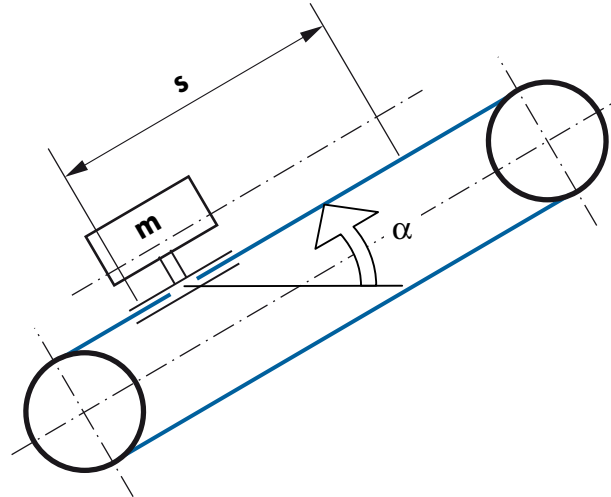

Figure 4.5.1: Linear drive, inclined arrangement

Calculation methods

The drive design is performed through the calculation of the circumferential force F_U . The basis for this is

- the drive torque M_N of the driving machine and
- the acceleration and friction forces.

If as in this example, the calculation method through the acceleration and friction forces is selected, the selected driving machine must subsequently be included in the drive design.

The calculation circumferential force F_{BU} and the calculation drive torque M_{BN} consider all loads acting on the belt.

Calculation circumferential force F_{BU} through the drive torque load M_N

The calculation method is shown here. An example can be seen in Subchapter 3.5 where concrete specifications for the drive torques of the motor are included.

The design can be made through the acting drive torque M_N and the calculation drive torque M_{BN} .

$$M_{BN} = \frac{c_2 \cdot M_N}{\text{Number of belts}} \quad [\text{Nm}] \quad \text{with } M_N [\text{Nm}]$$

The total drive service factor c_2 is composed of the type of base drive service factor, the additional loads by e.g. idlers and the starting frequency, see Subchapter 2.2.

Actual values to specific spring rate c_{spez} see 4.7 Technical Data Sheet.

4 LINEAR DRIVES

4.5 DRIVE DESIGN



The preliminary design circumferential force results from the intended and estimated diameter of the timing belt pulleys which can be derived e.g. from the specification for the installation space. In a recalculation, the precise diameter is inserted here, of course.

$$F_{BU} = M_{BN} \cdot \frac{2 \cdot 10^3}{d_w} \quad [\text{N}] \quad \text{with } M_{BN} [\text{Nm}], d_w [\text{mm}]$$

If the design circumferential force F_{BU} is already determined, the procedure can start directly with the pre-selection of the belt.

Design circumferential force F_{BU} through acceleration and friction forces

The mass m to be considered for the drive design is here composed of the mass to be moved m_1 and the mass of the linear slide m_2 .

The belt mass, the masses of the clamping plates and the moment of mass inertia of the concurrently moved second timing belt pulley represent additional loads. This is usually much smaller than the force to transport the mass and can therefore be ignored in most cases. The total drive service factor c_0 then also covers these subordinated forces. Only when very long distances of movement and large, heavy pulleys, are used, must this mass or moments of mass inertia be included precisely.

$$m = m_1 + m_2 \quad [\text{kg}] \quad \text{with } m_1 [\text{kg}] \text{ and } m_2 [\text{kg}]$$

$$m = 85 \text{ kg} + 15 \text{ kg} = 100 \text{ kg}$$

The basic formulas to determine the circumferential force F_U according to the external load are represented in Tables 2.1.4 and 2.1.5. The formula indicated there for F_U with acceleration force F_a and downward output force F_H is in the example below supplemented for completeness by the friction force F_R .

The largest load occurs in this example during the downward movement and simultaneous braking a_2 . The friction force acts generally against the direction of movement. During braking, the friction force hence supports the deceleration and relieves the belt. The circumferential force is reduced by this amount.

In summary, this results in a simplified way for acceleration and braking:

$$F_U = F_{U2} = F_{a2} + F_H + F_R \quad [\text{N}] \quad \text{with } F_{a2} [\text{N}], F_H [\text{N}] \text{ and } F_R [\text{N}]$$

$$F_U = 1100 \text{ N} + 491 \text{ N} + (-85 \text{ N}) = 1506 \text{ N}$$

$$F_U = m_{\text{total}} (a_2 + g \cdot \sin\alpha) + \mu \cdot m_{\text{total}} \cdot g \cdot \cos\alpha \quad [\text{N}]$$

$$F_U = 100 \text{ kg} \cdot \left(11 \frac{\text{m}}{\text{s}^2} + 9.81 \frac{\text{m}}{\text{s}^2} \cdot \sin 30^\circ \right) + (-0.1 \cdot 100 \text{ kg} \cdot 9.81 \frac{\text{m}}{\text{s}^2} \cdot \cos 30^\circ) = 1506 \text{ N}$$

The calculation circumferential force F_{BU} considers the total drive service factor c_2 and the external load for every single belt, if several ones work in parallel in contrast to this example.

The fact that the maximum load is always repeated at the same area of the belt tooth system should be taken into consideration when selecting total drive service factors. Lower loads, related to the remaining distance of movement, have no effect there.

4 LINEAR DRIVES

4.5 DRIVE DESIGN



The total drive service factor c_2 is composed of the type of the base drive service factor c_0 , the additional loads by the idlers c_6 and the starting frequency c_8 , see Subchapter 2.2.

$c_2 = c_0 + c_6 + c_8$ see Tables 2.2.1 and 2.2.2 where

$c_2 = 1.7 + 0 + 0.3 = 2.0$ c_0 : medium drive c_6 : no Omega drive c_8 : high frequency

$F_{BU} = \frac{c_2 \cdot F_U}{\text{Number of belts}}$ [N] with c_2 [-] and F_U [N]

$$F_{BU} = \frac{2.0 \cdot 1506 \text{ N}}{1} = 3012 \text{ N}$$

Selection of tooth system

The tooth system of the AT profile is selected which enables the maximum positioning accuracy due to the high tooth load bearing capacity and the smallest backlash. In addition, comparably light standard timing belt pulleys of aluminium, adjusted to the shaft/hub connection with a low moment of mass inertia can be used. The optional ATL profile enables an even higher positioning accuracy if the same timing belt pulleys are used.

Belt pre-selection of profile and width

With aid of Diagram 4.3.2 an optibelt ALPHA LINEAR 50 AT10 timing belt is selected here.

Calculation of the belt and pulley geometry

The selection of the pulley diameter is basically determined by the specified installation space. In addition, a sufficient space for the installation and dismantling of the belt must be provided. Open-ended belts for linear drives can be passed between the housing and the outside diameter of the pulley generally without dismantling the pulley. The outside diameter d_a of the timing belt pulley, the flange diameter D_B , the belt height can all be seen in the relevant Optibelt product range list, the pertaining Technical Data Sheet or Table 1.4.5 in Subchapter 1.4. The selection of the pulley diameter, relative to minimum values, is determined by the required shaft diameter and the shaft/hub connection, see product range list. The major features of the shaft/hub connections are detailed in Subchapter 7.2.

By selecting the belt profile and its technical design, the associated minimum number of teeth z_{\min} and the minimum pulley diameter $d_{w\min}$ of the timing belt pulley are defined, see Technical Data Sheet. The minimum pulley diameter for belts with steel cord are additionally indicated in Subchapter 7.3 and Table 7.3.4. For a first estimate, they can be seen in a simplified way in the Optibelt product range list.

The selected number of teeth of a standard pulley is included in the product range list. As an alternative and in the case of a special timing belt pulley, the number of teeth z is calculated based on the profile of pitch t of the selected belt and the intended pulley diameter.

4 LINEAR DRIVES

4.5 DRIVE DESIGN



The preliminary effective diameter is defined in this example with $d_w = 100$ mm.

$$z = \frac{d_w \cdot \pi}{t} = z_1 = z_2 \quad [-] \quad \text{with } d_w [\text{mm}] < d_{\max}, t [\text{mm}] \text{ depending on the profile}$$

$$z_1 = \frac{100 \text{ mm} \cdot \pi}{10 \text{ mm}} = 31.416 \text{ selected } z = 32 \quad z_1 > z_{\min} = 15 \text{ see e.g. Technical Data Sheet with } d_w + 2 h \text{ or } D_B < 150 \text{ mm}$$

From the standard product range, the timing belt pulley optibelt ZRS 66 AT10/32 - 2 with a number of teeth of $z = 32$, an effective diameter $d_w = 101.86$ mm and two flanges with a diameter $D_B = 106$ mm was selected. The timing belt must be protected on both sides against off-track running from at least one timing belt pulley. For drive centre distances $a > 8 d_w$ all timing belt pulleys should be equipped with flanges, see also Subchapter 7.3.

Rated tensile force

In the Technical Data Sheet of the selected belt, see Subchapter 4.7, the exact permissible tensile forces F_{allowed} for the individual widths from Diagrams 4.3.1 to 4.3.3 of the preselection for profile and width are included. The following applies:

$$F_{BU} < F_{\text{allowed}} \quad \text{For the open-ended timing belt optibelt ALPHA LINEAR 50 AT10 } F_{\text{allowed}} = 7350 \text{ N. The condition mentioned here is fulfilled with } F_{BU} = 3012 \text{ N.}$$

The rated tensile force F_N refers to the tooth system of the belt. The load bearing capacity of the tooth flanks is reduced with increasing speed n . This is shown in the table of the Technical Data Sheet with the title "Specific nominal tensile force transmittable per tooth". The rated tensile force F_N can be calculated, as indicated in the Technical Data Sheet or in Table 2.1.3, from the belt width b and the calculation tooth number z_{eB} . This results from the engaging number of teeth z_e , which is limited to $z_{eB \max} = 12$, also see Table 2.1.2:

$$F_N = F_{N \text{ spec}} \cdot z_{eB} \cdot b \quad [\text{N}] \quad \text{with } F_{N \text{ spec}} [\text{N/mm}] \text{ from Technical Data Sheet interpolated, } z_{eB} [-] \text{ and } b [\text{mm}]$$

$$F_N = 5.34 \frac{\text{N}}{\text{mm}} \cdot 12 \cdot 50 \text{ mm} = 3204 \text{ N}$$

$$n = \frac{19.1 \cdot 10^3 \cdot v}{d_w} \quad \left[\frac{1}{\text{min}} \right] \quad \text{with } v \left[\frac{\text{m}}{\text{s}} \right], d_w [\text{mm}]$$

$$n = \frac{19.1 \cdot 10^3 \cdot 4 \frac{\text{m}}{\text{s}}}{101.86 \text{ mm}} = 750 \frac{1}{\text{min}}$$

$$z_e = \frac{z_1}{2} \quad z_{eB} = z_e \text{ and } z_{eB} \leq z_{e \max} \quad \text{with } z_{e \max} = 12 \text{ for optibelt ALPHA LINEAR}$$

$$z_e = \frac{32}{2} = 16 \quad z_{eB} = 12$$

The existing safety factor $c_{2\text{actual}}$, related to the load on the tooth system, is:

$$c_{2\text{actual}} = \frac{F_N \cdot \text{number of belts}}{F_U} \quad [-] \quad \text{with } F_N [\text{N}], F_U [\text{N}] \text{ and } c_{2\text{actual}} \geq c_2$$

$$c_{2\text{actual}} = \frac{3204 \text{ N} \cdot 1}{1506 \text{ N}} = 2.12 \geq 2.0$$

4 LINEAR DRIVES

4.5 DRIVE DESIGN



Optionally the required width b_{th} can be determined.

$$b_{th} = b \cdot \frac{c_2}{c_{2actual}} \quad [\text{mm}] \quad \text{with } b \text{ [mm]}$$

$$b_{th} = 50 \text{ mm} \cdot \frac{2}{2.12} = 47 \text{ mm}$$

If the required width b_{th} is slightly higher than the next smallest standard width of the selected timing belts and timing belt pulleys, a reduction of the selected total drive service factor c_2 to a still acceptable smaller value should be considered. This helps to avoid unnecessary costs, if desirable. In slowly running linear drives with a correspondingly higher rated tensile force, the following subchapter, and for increased accuracy requirements, the subchapter about positioning accuracy should be considered for the decision on the width selection.

For a drive torque led design, the required width – as far as this is permitted e.g. by the installation space – can be reduced by an increased pulley diameter.

Static and maximum belt tension

The formula for the calculation of the static belt tension is indicated in Table 2.1.7 in Chapter 2.1, as it applies to linear drives up to medium-sized drive centre distances.

$$F_T = \frac{1.0 \cdot c_v \cdot F_U}{\text{Number of belts}} \quad [\text{N}] \quad \text{with } F_U \text{ [N] and } c_v \text{ [-]}$$

$$F_T = \frac{1.0 \cdot 1.0 \cdot 1506 \text{ N}}{1} = 1506 \text{ N}$$

For linear drives with large distances of movement and drive centre distances in proportion to the selected profile, an increase of the static belt tension can be obtained through the circumferential force F_U . Then the following applies: $F_T > F_U$

The cords used in the optibelt ALPHA LINEAR timing belts in technical standard designs are selected generally consistently with the tooth system and the maximum possible rated tensile force and do not therefore require any additional verification for the design of a linear drive through the determination of F_{max} and the alignment with $F_{allowed}$.

An exception is linear drives which are arranged vertically or almost vertically and equipped with an additional counterweight opposite the linear slide.

For the linear drives described in the above paragraph with long drive centre distances and $F_T > F_U$, a verification can be made. Here, a comparatively high belt tension, related to the cords – not to the tooth system – occurs, as the loaded span side is only very short and the maximum circumferential force F_U might act there at the same time. The static belt tension F_T and the circumferential force F_U are added together. In a simplified way, the following applies here:

$$F_{max} = F_T + \frac{F_U}{\text{Number of belts}} \quad [\text{N}] \quad \text{with } F_T \text{ [N], } F_U \text{ [N]}$$

Not required for the selected design example and only mentioned as an example:

$$F_{max} = 1506 \text{ N} + \frac{1506 \text{ N}}{1} = 3012 \text{ N}$$

The following applies:

$$F_{max} \leq F_{allowed} \quad \text{with } F_{allowed} = 7350 \text{ N for the 50 AT10, this condition is fulfilled.}$$

For high requirements regarding the positioning accuracy, this can be determined through the elastic elongation of the selected timing belt in a simplified way. The calculation method and further explanations about the positioning accuracy are indicated at the end of this subchapter.

4 LINEAR DRIVES

4.5 DRIVE DESIGN



Static shaft loading

$$F_{a\ sta} = 2 \cdot F_T \quad [\text{N}] \quad \text{per belt with } F_T [\text{N}]$$

$$F_{a\ sta} = 2 \cdot 1506 \text{ N} = 3012 \text{ N} \quad \text{per belt}$$

In the case described above for linear drives with large drive centre distances, the dynamic shaft loading can, temporarily be $2 \cdot F_T + F_U$.

Belt length and order designations

$$L_w = 2 \cdot a + z \cdot t \quad [\text{mm}] \quad \text{with } a [\text{mm}], t [\text{mm}]$$

$$L_w = 2 \cdot 2600 \text{ mm} + 32 \cdot 10 \text{ mm} = 5520 \text{ mm} \quad \text{selected } 5510 \text{ mm}$$

One pitch length can be deducted from the calculated belt length, if applicable, between the belt ends at the linear slide, here $t = 10 \text{ mm}$.

If in addition a potential requirement for the positioning accuracy is fulfilled, see Subchapter 4.6, the order designations for the belt, timing belt pulleys and clamping plates are:

1 pc. **optibelt ALPHA LINEAR 50 AT10/5510-ST**

2 pcs. **optibelt ZRS 66 AT10/32-2**

2 pcs. **optibelt CP - 50 AT10**

Depending on the shaft/hub connection of the drive pulley and the bearing of the guide pulley, the timing belt pulleys can also be ordered as special pulleys.

The minimum number of teeth $z_{cp\ min}$ of the timing belt in engagement with the clamping plate can be seen in the relevant Technical Data Sheet, also see Subchapter 7.3 for clamping plates.

Belt tension adjustment through frequency measurement

The specification for the adjustment of the static belt tension through frequency measurement can be calculated depending on the freely oscillating span length L and the weight per metre m_K of the selected belt. The weight per metre m_K can be seen in the relevant Technical Data Sheet. Figure 4.5.2 shows that with increasing span length L the natural frequency f drops.

Further information about frequency measurement are included in Chapter 7.1.

$$f = \sqrt{\frac{F_T \cdot 10^6}{4 \cdot m_K \cdot L^2}} \quad [\text{Hz}] \quad \text{with } F_T [\text{N}], m_K \left[\frac{\text{kg}}{\text{m}} \right] \text{ or } \left[\frac{\text{g}}{\text{mm}} \right], L [\text{mm}]$$

$$f = \sqrt{\frac{1506 \text{ N} \cdot 10^6}{4 \cdot 0.300 \frac{\text{kg}}{\text{m}} \cdot (1000 \text{ mm})^2}} = 35.4 \text{ Hz} \quad L = 1000 \text{ mm for movable linear slide}$$

For a linear drive and freely movable linear slide, any span length, above e.g. 1000 mm, can be adjusted between the clamping length of the slide and a timing belt pulley to achieve, for example, a specified value for the frequency $f \geq 10 \text{ Hz}$ (refer to the measuring range of the optibelt TT series measuring instrument).

The result of the calculation of the specification of the natural frequency of the long span side $L = a$, which is opposite the linear slide, shows in the example below a value smaller than 10 Hz. This long span side is here not suitable for the frequency measurement.

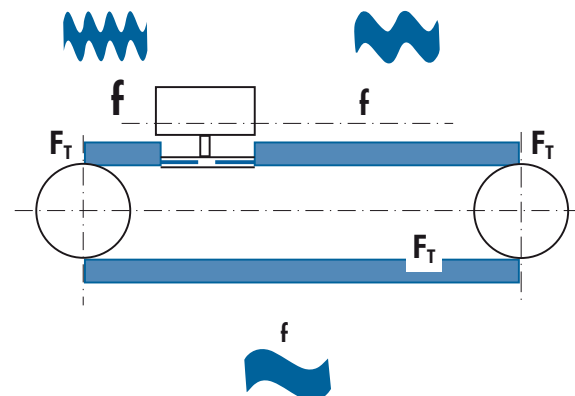

Figure 4.5.2: Frequency f depending on static belt tension F_T and span length L

4 LINEAR DRIVES

4.5 DRIVE DESIGN



$$f = \sqrt{\frac{1506 \text{ N} \cdot 10^6}{4 \cdot 0.300 \frac{\text{kg}}{\text{m}} \cdot (2600 \text{ mm})^2}} = 4.8 \text{ Hz} \quad L = a = 2600 \text{ mm}$$

For linear drives which perform inclined or vertical movements, the linear slide must be supported to adjust the static belt tension and released from further masses to be moved. Then the mass of the linear slide can be ignored, if it is small in proportion to the mass to be moved. If at all possible, the adjustment of the belt tension F_T should be made on a horizontal level.

Belt tension adjustment through measurement of the elongation

The belt tension adjustment through measurement of the elongation does generally not achieve the accuracy of the belt tension adjustment through the measurement of the natural frequency of a freely oscillating span side. The belt tension adjustment through the measurement of the elongation is described in Chapter 7.1.

The generally applicable maximum guide value for the static span elongation ϵ_{FT} of linear drives is:

Guide value $\epsilon_{FT} \leq 0.2 \%$

With an assumed drive centre distance $a = 1000 \text{ mm}$, a shaft can be moved from the unloaded side by the tension length $x_V \leq 2 \text{ mm}$ for tensioning.

A span side with a marked span length $L_V = 1000 \text{ mm}$ can alternatively be stretched by the elongation $\Delta L_V \leq 2 \text{ mm}$ from the unloaded side. For larger span lengths, it is recommended, to achieve a higher accuracy for the adjustment in the unloaded side, to mark a corresponding multiple of 1000 mm , e. g. 3000 mm , on an accessible span side and tension here by the elongation $\Delta L_V \leq 6 \text{ mm}$ to a maximum of 3006 mm . In practice, e.g. 3004 mm would be suitable.

The tension length x_{VCP} of a clamping plate, see Figure 4.5.3, would be 12 mm for an e.g. 3000 mm long belt.

The precise belt tension length x_V , related to the shafts, or the precise elongation ΔL_V , related to a marked length L_V of a previously unloaded span side under the static belt tension F_T , results from the particular spring rigidity of the timing belt. This also applies to the tension length x_{VCP} .

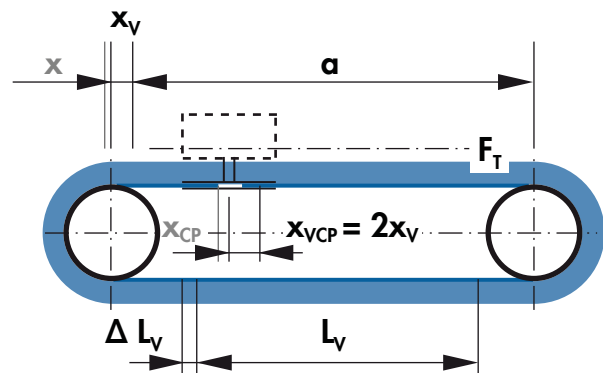

Figure 4.5.3: Belt tension adjustment through the measurement of the elongation ΔL_V

$$x_V = \epsilon_{FT} \cdot a \quad [\text{mm}] \quad \text{with } \epsilon_{FT} [\%], a [\text{mm}] \quad \text{here } x_V = 0.00113 \cdot 2600 \text{ mm} = 2.9 \text{ mm}$$

with

$$\epsilon_{FT} = \frac{F_T}{c_{\text{spec}}} \quad [\%] \quad \text{with } F_T [\text{N}], c_{\text{spec}} [\text{N}] \quad \text{here } \epsilon_{FT} = \frac{1506 \text{ N}}{1336364 \text{ N}} = 0.001127 = 0.113 \%$$

$$c_{\text{spec}} = \frac{F_{\text{allowed}}}{\epsilon_{\text{allowed}}} \quad [\text{N}] \quad \text{with } F_{\text{allowed}} [\text{N}], \epsilon_{\text{allowed}} [\%] \quad \text{here } c_{\text{spec}} = \frac{7350 \text{ N}}{0.55 \%} = 1336364 \text{ N}$$

More precise values for the permissible elongation $\epsilon_{\text{allowed}}$ are indicated in Table 4.5.1 and the respective profile, here the AT10 profile with $\epsilon_{\text{allowed}} = 0.55 \%$ in the standard cord design ST. For simplification, all profiles and designs can be calculated with $\epsilon_{\text{allowed}} = 0.5\%$. Actual values to specific spring rate c_{spez} see 4.7 Technical Data Sheet.

4 LINEAR DRIVES

4.5 DRIVE DESIGN



The tension length x_V can be determined even more precisely:

$$x_V = \varepsilon_{FT} \cdot \frac{L_1 + L_2}{2} \quad [\text{mm}] \quad \text{with } \varepsilon_{FT} [\%], L_1 [\text{mm}], L_2 [\text{mm}] \quad x_V = 0.00113 \cdot \frac{5320 \text{ mm}}{2} = 3.0 \text{ mm}$$

This sum of span lengths L_1 and L_2 is a result of the unshortened calculated belt length L_w minus the slide length L_s .

$$L_1 + L_2 = L_w - L_s \quad [\text{mm}] \quad \text{with } L_w [\text{mm}], L_s [\text{mm}] \quad L_1 + L_2 = 5520 \text{ mm} - 200 \text{ mm} = 5320 \text{ mm}$$

For a marked length of e.g. $L_V = 2000$ mm, the following applies to the exact elongation ΔL_V :

$$\Delta L_V = \varepsilon_{FT} \cdot L_V \quad [\text{mm}] \quad \text{with } \varepsilon_{FT} [\%], L_V [\text{mm}] \quad \Delta L_V = 0.00113 \cdot 2000 \text{ mm} = 2.3 \text{ mm}$$

For the belt tension length x_{CPV} of an adjustable optibelt CP clamping plate for non-movable shafts and the static belt tension F_T the above formula applies, however, refers to the total belt length and is hence larger by a factor 2. This formula applies in the same way without changes to linear drives with

- linear slide,
- traveller

or linear table variations. ε_{FT} see above or here below in with F_T , F_{allowed} and $\varepsilon_{\text{allowed}}$:

$$x_{CPV} = \varepsilon_{FT} \cdot (L_1 + L_2) = \frac{F_T}{F_{\text{allowed}}} \cdot \varepsilon_{\text{allowed}} \cdot (L_1 + L_2) \quad [\text{mm}] \quad \text{with } \varepsilon [\%], L [\text{mm}] \text{ and } F [\text{N}]$$

$$x_{CPV} = 0.00113 \cdot 5320 \text{ mm} = \frac{1506 \text{ N}}{7350 \text{ N}} \cdot 0.0055 \cdot 5320 \text{ mm} = 6.0 \text{ mm}$$

Allowances for tensioning and fitting

Subchapter 7.5 contains general information about the allowances and Table 7.5.2 contains formulas and supplementary guide values for the minimum allowances.

The allowance x of a single shaft for tensioning optibelt ALPHA LINEAR timing belts can be determined in a simplified way, if the optibelt CP clamping plates on the linear slide are non-movable.

$$x = 0.0035 \cdot a \quad [\text{mm}] \quad \text{with } a [\text{mm}]$$

$$x = 0.0035 \cdot 2600 \text{ mm} = 9.1 \text{ mm}$$

The allowance y of a single shaft for fitting an open-ended optibelt ALPHA LINEAR timing belt can be derived from the length tolerance as follows:

$$y = 0.0005 \cdot a \quad [\text{mm}] \quad \text{with } a [\text{mm}]$$

$$y = 0.0005 \cdot 2600 \text{ mm} = 1.3 \text{ mm}$$

Although the flanges are available here, the formula can be selected for the clearance space in Table 7.5.2, since the open-ended timing belt can be easily passed through and fitted here due to the sufficient space between the flanges.

Alternatively, the allowance of a movable optibelt CP clamping plate x_{CP} can be determined in a simplified way, also see Table 7.1.4:

$$x_{CP} = 2 \cdot x \quad [\text{mm}] \quad \text{with } x [\text{mm}] \text{ or slightly more precise } x_{CP} = 0.0035 \cdot L_w [\text{mm}] \quad \text{with } L_w [\text{mm}]$$

$$x_{CP} = 2 \cdot 9.1 \text{ mm} = 18.2 \text{ mm} \quad x_{CP} = 0.0035 \cdot 5510 \text{ mm} = 19.3 \text{ mm}$$

4 LINEAR DRIVES

4.5 DRIVE DESIGN



Likewise, the following applies to the allowance y_{CP} for fitting in a simplified way:

$$y_{CP} = 2 \cdot y \quad [\text{mm}] \quad \text{with } y \text{ [mm] or slightly more precise } y_{CP} = 0.0005 \cdot L_w \quad [\text{mm}] \quad \text{with } L_w \text{ [mm]}$$

$$y_{CP} = 2 \cdot 1.3 \text{ mm} = 2.6 \text{ mm} \qquad x_{CP} = 0.0005 \cdot 5510 \text{ mm} = 2.8 \text{ mm}$$

If required, it can be calculated even slightly more precisely by using, instead of the belt length L_w , the sum of L_1 and L_2 , see below.

If the allowance x or x_{CP} to be provided must be minimised, the following more precise formulas can be used. Using these, the allowance x_V , see above, and the allowance x_{Ltol+} , which considers the length tolerance per meter, are added. Information on ϵ_{FT} , L_1 , L_2 are also given in the profile above.

$$x = x_V + x_{Ltol+} = (\epsilon_{FT} + \epsilon_{Ltol+}) \cdot \frac{L_1 + L_2}{2} \quad [\text{mm}] \quad \text{with } \epsilon_{FT} \text{ [%], } \epsilon_{Ltol+} \text{ [%] – see below –, } L \text{ [mm]}$$

$$x = 3.0 \text{ mm} + 1.3 \text{ mm} = (0.00113 + 0.0005) \cdot \frac{5320 \text{ mm}}{2} = 4.3 \text{ mm}$$

The length tolerance can be seen on the relevant Technical Data Sheet or the Subchapter 7.4. For optibelt ALPHA LINEAR timing belts in technical standard design with standard steel cord ST this is consistently $\pm 0.5 \text{ mm/m}$ and accordingly in the positive range $L_{tol+} = 0.5 \text{ mm/m}$.

This then corresponds to an elongation $\epsilon_{Ltol+} = 0.0005$ or 0.05 %. Generally the following applies:

$$x_{Ltol+} = \epsilon_{Ltol+} \cdot \frac{L_w + L_s}{2} \quad [\text{mm}] \quad \text{with } \epsilon_{Ltol+} \text{ [%], } L_w \text{ [N], } L_s \text{ [N] here}$$

$$x_{Ltol+} = 0.0005 \cdot \frac{5320 \text{ mm}}{2} = 1.3 \text{ mm}$$

$$\epsilon_{Ltol+} = \frac{L_{tol+}}{1000} \quad [\%] \quad \text{with } L_{tol+} \text{ [mm/m]} \quad \text{here } \epsilon_{Ltol+} = \frac{0.5 \text{ mm/m}}{1000} = 0.0005 = 0.05 \%$$

If the formula connections are directly inserted for the elongations and span lengths, the following applies:

$$x = \left(\frac{F_T}{F_{allowed}} \cdot \epsilon_{allowed} + \frac{L_{tol+}}{1000} \right) \cdot \frac{L_w \cdot L_s}{2} \quad [\text{mm}]$$

$$x = \left(\frac{1506 \text{ N}}{7350 \text{ N}} \cdot 0.0055 + \frac{0.5 \text{ mm/m}}{1000} \right) \cdot \frac{5520 \text{ mm} - 200 \text{ mm}}{2} = 4.3 \text{ mm}$$

For the allowance x_{CP} of an adjustable optibelt CP clamping plate, the following applies to linear drives with linear slides, linear tables or with travellers and non-movable shafts in the same way:

$$x_{CP} = (\epsilon_{FT} + \epsilon_{Ltol+}) \cdot (L_1 + L_2) \quad [\text{mm}] \quad \text{with } \epsilon_{FT} \text{ [%], } \epsilon_{Ltol+} \text{ [%], } L_1 \text{ [mm], } L_2 \text{ [mm] see above}$$

$$x_{CP} = \left(\frac{F_T}{F_{allowed}} \cdot \epsilon_{allowed} + \frac{L_{tol+}}{1000} \right) \cdot (L_w - L_s) \quad [\text{mm}]$$

$$x_{CP} = \left(\frac{1506 \text{ N}}{7350 \text{ N}} \cdot 0.0055 + \frac{0.5 \text{ mm/m}}{1000} \right) \cdot (5520 \text{ mm} - 200 \text{ mm}) = 8.6 \text{ mm}$$

4 LINEAR DRIVES

4.6 REPETITION AND POSITIONING ACCURACY



Due to the tolerance fields in the negative range, ATL profiles generally offer an additional optimisation potential, which is not utilised, however, in this example with AT10 profile.

Table 4.5.1 indicates the elongation values $\epsilon_{\text{allowed}}$ of optibelt ALPHA LINEAR timing belts with the permissible tensile force F_{allowed} of the cords. The width-dependent permissible tensile forces depend on the profile and cord in the most up to date relevant Technical Data Sheet.

Table 4.5.1: Elongation values at permissible tensile force

Profile	Cord ¹	Elongation $\epsilon_{\text{allowed}}$ at F_{allowed} ²	Profile	Cord ¹	Elongation $\epsilon_{\text{allowed}}$ at F_{allowed} ²
AT5, 5M	ST	0.47 %	T5, XL	ST	0.44 %
AT5, 5M	HF	0.55 %	L	ST	0.47 %
AT10, 8M	ST	0.55 %	L	HF	0.55 %
AT10, 8M	HF	0.52 %	T10, H	ST	0.45 %
AT20, 14M	ST	0.50 %	T10, H	HF	0.54 %
ATL5	ST	0.45 %	T20	ST	0.55 %
ATL5	HF	0.54 %	XH	ST	0.40 %
ATL10	ST	0.50 %	T20	HF	0.52 %
ATL20, 14ML	ST	0.65 %			

¹ ST: Steel cord, technical standard design, HF: Steel cord, highly flexible

² F_{allowed} : width-dependent value, see Technical Data Sheet for the profile

4.6 Repetition and Positioning Accuracy

The repetition accuracy defines a tolerance field which can be identified in the repetitive action of a linear slide under the same conditions. Depending on the size of the linear drive, the repetition accuracy usually has a magnitude of only a few tenths of a millimetre and for smaller linear drives, even lower.

The positioning accuracy designates the deviation around a position, which occurs during the transfer of a defined rotary movement of an ideal timing belt pulley through an ideal timing belt into an accordingly defined linear movement. The deviation from the ideal position basically results, with a correct belt tension adjustment, from the production tolerances of the driving elements and the elastic elongation of the belt.

The deviation from the ideal position depends e.g. on

- the tolerances of the pulleys, such as
 - the run out accuracy of the pulleys or idlers: d_a and d_w deviated over the circumference due to an eccentric drilling hole,
 - the pitch error of the timing belt pulley: d_a and d_w deviate (on average) from the ideal value,
- the tolerances of the timing belt, such as
 - the mean pitch error of the timing belt: The effective diameter d_w of the belt deviates from the ideal value on an ideal timing belt pulley (on average),
 - the length deviation within the belt: The real pitch deviates over the length of the belt from the ideal pitch,
- the backlash between belt and pulley when the rotation is reversed.

4 LINEAR DRIVES

4.6 REPETITION AND POSITIONING ACCURACY



The restriction of tolerances or a restricted backlash is possible, but is also complex and results in additional costs. This means that for T and AT profiles zero gap pulleys to meet increased requirements regarding the positioning accuracy can be used, which at the same time put high restrictions on the load bearing capacity of the belt drive. In relation to the selected pitch, large pulleys, clearly above the minimum pulley diameter, generally reduce the influence of the backlash and unavoidable production tolerances especially of the timing belt.

Small optibelt ZRS standard timing belt pulleys in the T profiles are generally equipped with an SE tooth system with restricted backlash below the number of teeth $z = 21$. AT profiles generally exhibit a restricted backlash. For special applications, the HTD profile 8M with a zero gap tooth system is available.

The magnitude of the deviation depends much more on the ideal position of the elastic elongation of the belt than on the production tolerances. The timing belt and its cords act in longitudinal direction under load in the same way as an elastic spring which stretches increasingly with a growing tensile force. This has been explained in the above profile about belt tension adjustment and allowances as well as in Subchapter 7.1.

The elastic elongation ε of a spring or the timing belt is generally smaller, when

- the profile and width of the belt and hence the rated tensile force F_N are larger in proportion to the circumferential force F_U .

In other words, the smaller the elastic elongation ε of the belt under the same load is, the greater the specific spring rate c_{spec} will be. Actual values to specific spring rate c_{spez} see 4.7 Technical Data Sheet.

The length of the elastic deformation Δs is additionally lower under the same load to that extent,

- to which a spring, here a belt span, is shorter. As a result, linear drives with short distances of movement and small drive centre distances generally exhibit higher spring rigidities and smaller positional deviations under the same load than otherwise equally dimensioned linear drives with larger distances of movement and drive centre distances.

For linear drives, the spring rigidity increases as smaller the short span is in proportion to the long span. Figure 4.6.1 shows a linear drive, where a mass that moves to the left is decelerated. The mass inertia generates primarily in a comparably long span side L_1 a small increase of force, because of the high decrease of force in the short span L_2 . With a further movement of the mass to the left and a constant braking force F_U – without a picture – the spring travel Δs would further increase due to the elongation of the primarily loaded span side L_1 and the further unloaded short span only in the case, when the force F_U would overlap the static tension F_T .

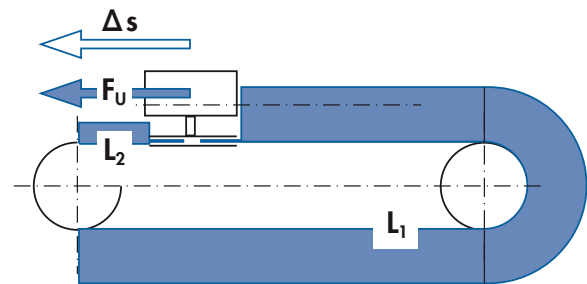

Figure 4.6.1: Long loaded span side L_1 , driver pulley, left side

Figure 4.6.2 shows a reverse of direction of the force F_U from Figure 4.6.1. This would occur with an acceleration towards the drive pulley. Since at this same position of the slide, the primarily acting tight side L_1 is now very short by comparison, the spring travel Δs would be considerably shorter than for the long tight side L_1 of Figure 4.6.1.

The positioning accuracy in an existing linear drive and correct adjusted static tension force F_T increases with the reduction of the distance between slide and driver pulley, see also Figure 4.6.3 und 4.6.4.

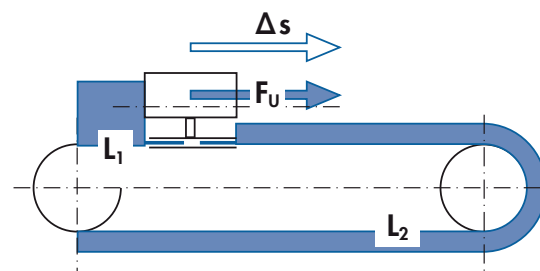

Figure 4.6.2: Short loaded span side L_1 , driver pulley, left side

4 LINEAR DRIVES

4.6 REPETITION AND POSITIONING ACCURACY



During braking, the belt is stretched more, due to the mass inertia than during a consistent movement at a constant velocity v or during standstill where no acceleration forces F_{a2} act. At the end of the braking process, the linear slide can spring beyond a position that is not loaded with acceleration forces in order to spring back to a final position. This is only counteracted by any existing friction forces that damp the spring-back process. As a result, the final position can deviate in both directions from the intended position.

In a simplified way, the deviation of an ideal, externally unloaded slide position, solely caused by elastic elongation of the belt under load, can be calculated with the following formula.

$$\Delta s = \frac{F_U}{c_{spez}} \cdot \frac{L_1 \cdot L_2}{L_1 + L_2} \quad [\text{mm}] \quad \text{mit } F_U [\text{N}], c_{spez} [\text{N}], L_1 [\text{mm}], L_2 [\text{mm}]$$

For the example shown here with $a = 2600 \text{ mm}$, a slide length L_s of 200 mm , an adjustment distance s of 2100 mm and equal distances between slide and pulleys, this results in the following span lengths L_l on the left side and L_r on the right side of the end position:

$$L_l = (a - (s + L_s)) \cdot \frac{1}{2} \quad [\text{mm}]$$

$$L_l = (2600 \text{ mm} - (2100 \text{ mm} + 200 \text{ mm})) \cdot \frac{1}{2} = 150 \text{ mm}$$

$$L_r = a - (L_l + L_s) \quad [\text{mm}]$$

$$L_r = 2600 \text{ mm} - (150 \text{ mm} + 200 \text{ mm}) = 2250 \text{ mm}$$

For the calculation of the loaded and unloaded span sides L_1 and L_2 , the contact length on the drive pulley is as shown simply, in Figures 4.6.1 and 4.6.2. For a more accurate calculation, one quarter of the contact with the drive pulley can be assumed as additional free span length.

If the drive in the example of a linear drive is on the left side and the slide on the left in the end position P1, this results in the length L_{kp1} for the short span side and the length L_{gp1} for the long span side:

$$L_{kp1} = L_l \quad [\text{mm}] \quad L_{kp1} = 150 \text{ mm}$$

During braking, i.e. due to the downward force, this is the unloaded span side L_{2p1} .

$$L_{gp1} = 2 \cdot a + \frac{z}{2} \cdot t - (L_{kp1} + L_s) \quad [\text{mm}] \quad \text{with } a [\text{mm}], z [-], t [\text{mm}] \text{ and } L [\text{mm}]$$

$$L_{gp1} = 2 \cdot 2600 \text{ mm} + \frac{32}{2} \cdot 10 \text{ mm} - (150 \text{ mm} + 200 \text{ mm}) = 5010 \text{ mm}$$

During braking, i.e. due to the downward force, this is the loaded span side L_{1p1} .

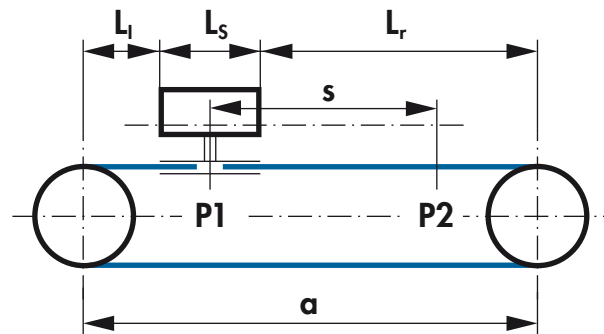

Figure 4.6.3: Span lengths on left and right sides of the slide, driver pulley in example on left side

4 LINEAR DRIVES

4.6 REPETITION AND POSITIONING ACCURACY



In contrast, in position P2, the following applies due to the elongated span side $L_1 = 2250 \text{ mm}$ (previously L_r):

$$L_{kP2} = L_1 \quad [\text{mm}] \quad \text{here } L_{kP2} = 2250 \text{ mm}$$

If the downward force is active, this is the unloaded span side L_{2P2} .

$$L_{gP1} = 2 \cdot 2600 \text{ mm} + \frac{32}{2} \cdot 10 \text{ mm} - (2250 \text{ mm} + 200 \text{ mm}) = 2910 \text{ mm}$$

If the downward force is active, this is the loaded span side L_{1P2} .

Consequently, the following can be derived for the positions P1 and P2 for the elastic deformation only due to the downward force and the friction force, which is counteracting here:

$$\Delta s_{P1} = \frac{F_H + F_R}{c_{\text{spec}}} \cdot \frac{L_{1P1} \cdot L_{2P1}}{L_{1P1} + L_{2P1}}$$

$$\Delta s_{P1} = \frac{491 \text{ N} + (-85 \text{ N})}{1336364 \text{ N}} \cdot \frac{150 \text{ mm} \cdot 5010 \text{ mm}}{150 \text{ mm} + 5010 \text{ mm}} = 0.044 \text{ mm}$$

$$\Delta s_{P2} = \frac{F_H + F_R}{c_{\text{spec}}} \cdot \frac{L_{1P2} \cdot L_{2P2}}{L_{1P2} + L_{2P2}}$$

$$\Delta s_{P2} = \frac{491 \text{ N} + (-85 \text{ N})}{1336364 \text{ N}} \cdot \frac{2250 \text{ mm} \cdot 2910 \text{ mm}}{2250 \text{ mm} + 2910 \text{ mm}} = 0.39 \text{ mm}$$

It is shown that the elastic deformation in direction of the idler P1 to position P2 is multiplied, see Figure 4.6.4:

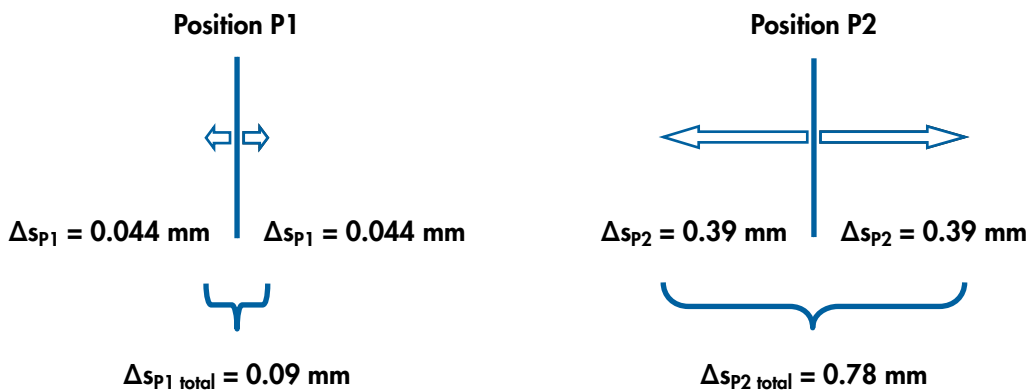

Figure 4.6.4: Position-dependent elastic deformations of the belt under the same load acting

If the position deviation from the belt elongation is too high, either a larger belt width or a timing belt in the ATL profile with reinforced tension cords should be selected.

4 LINEAR DRIVES

4.7 TECHNICAL DATA SHEET



4.7 Technical Data Sheet

Linear drives can be designed with the information of the Technical Data Sheets of the product group optibelt ALPHA LINEAR timing belts, further data of this Technical Manual and the current Optibelt product range list. In Subchapter 4.5, this is done generally and according to the example of an optibelt ALPHA LINEAR timing belt with the AT10 profile of the ST standard design.

The relevant up-to-date Technical Data Sheets are available on the website www.optibelt.com. There, you can download the optibelt CAP software for drive design of power drives free of charge and to obtain further current information about services and products.

Technical Data Sheet

optibelt ALPHA LINEAR / V AT10 - ST

Polyurethane Timing Belt, Optionally With Fabric PAZ/PAR, Thermoplastic PU, Open-Ended / Endless Joined



Dimensions, Tolerances

Profile:	AT10
Tooth pitch t:	10 mm
Total thickness:	4.5 mm
Tooth height:	2.5 mm
Tooth tip width:	5.0 mm
Tooth flank angle:	50°
Length tolerance:	±0.5 mm/m
Width tolerance:	±0.5 mm
Thickness tolerance:	±0.3 mm

Construction

Polyurethane:	Thermoplastic, 92 Shore A, white
Tension cord:	Steel, Ø 0.9 mm
Fabric, optional:	Polyamide, tooth and back (PAZ/PAR), green

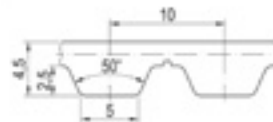

Specific nominal tensile force transmittable per tooth

Input speed n_1 [1/min]	Spec. nom. tensile force $F_{N\ spez}$ [N/mm]	Input speed n_1 [1/min]	Spec. nom. tensile force $F_{N\ spez}$ [N/mm]	Input speed n_1 [1/min]	Spec. nom. tensile force $F_{N\ spez}$ [N/mm]
0	7.500	1200	4.734	3600	3.164
20	7.382	1300	4.627	3800	3.083
40	7.273	1400	4.527	4000	3.005
60	7.170	1500	4.432	4500	2.826
80	7.073	1600	4.343	5000	2.664
100	6.982	1700	4.259	5500	2.518
200	6.590	1800	4.178	6000	2.383
300	6.275	1900	4.102	6500	2.259
400	6.012	2000	4.029	7000	2.143
500	5.785	2200	3.892	7500	2.036
600	5.586	2400	3.766	8000	1.935
700	5.409	2600	3.649	8500	1.840
800	5.250	2800	3.540	9000	1.750
900	5.104	3000	3.437	9500	1.665
1000	4.971	3200	3.341	10000	1.584
1100	4.848	3400	3.250	$v_{max} = 60$ m/s	

Nominal tensile force F_N

$$F_N = F_{N\ spez} \cdot z_{eB} \cdot b \quad [N]$$

$F_{N\ spez}$ Specific nominal tensile force transmittable per tooth [N/mm]
 z_{eB} Number of teeth in mesh, driver pulley, limited to $z_{eB\ max}$
 $z_{eB\ max}$ ALPHA LINEAR: 12, ALPHA V: 6
 b Belt width [mm]

Nominal torque M_N

$$M_N = F_N \cdot d_{w1} / (2 \cdot 10^3) \quad [Nm]$$

$$d_{w1} = z_1 \cdot t / \pi \quad [mm]$$

d_{w1} Pitch diameter, driver pulley [mm]
 z_1 Number of teeth, driver pulley
 t Tooth pitch [mm]

Nominal power P_N

$$P_N = F_N \cdot z_1 \cdot t \cdot n_1 / (6 \cdot 10^7) \quad [kW]$$

n_1 Speed, driver pulley [1/min]

Cord tensile force, minimum belt length, belt weight

Belt width ¹ b [mm]	16	25	32	50	75	100	150
F_{Br} [N], ALPHA LINEAR	7600	12320	17080	28480	43680	60800	91200
F_{zul} [N] ² , ALPHA LINEAR, $\epsilon_{zul}=0,55\%$	1900	3080	4270	7120	10920	15200	22800
F_{zul} [N] ² , ALPHA V/short joining	950	1540/770 ³	2135/1070 ³	3560/1780 ³	5460	7600	11400
Minimum belt length/short joining [mm]	700	700/400 ³	700/400 ³	700/400 ³	900	900	1100
Weight per metre [kg/m]	0.096	0.150	0.192	0.300	0.450	0.600	0.900

¹ Smaller and intermediate widths possible ² Allowable tensile force $F_{zul} = 25\% / 12.5\%$ (ALPHA LINEAR / V) of cord breaking strength F_{Br} $C_{spez} = F_{zul} / \epsilon_{zul}$ [N]
³ Short joining from 400mm, allowable tensile Force $F_{zul} = 50\%$ of a standard joining

Timing belt pulleys, idlers, clamping plates



Minimum no. of teeth of the pulleys:
 Minimum pitch diameter of the pulleys:
 Minimum no. of teeth in mesh, clamp. plate:
 Minimum-Ø of a plane inside idler:
 Minimum-Ø of a plane outside idler:

$Z_{min} = 15$
 $d_{w\ min} = 47.75$ mm
 $Z_{CP\ min} = 6$
 $d_{min} = 42$ mm
 $d_{min} = 100$ mm

We would be pleased to offer advice about technical characteristics and drive design as well as special requirements. Further information can be found in OPTIBELT documentation. © OPTIBELT GmbH 03/2014. Subject to technical modification and change, errors and omissions excepted.

5 TRANSPORT DRIVES

5.1 GENERAL



5.1 General

Subchapters 1.1 to 1.3 also contain the applications, characteristics, production processes and structures of all product groups of the polyurethane timing belts. These are summarised and supplemented in this chapter for transport drives and the associated product group optibelt ALPHA V including directly coated base belts.

Base belts of cast polyurethane for very simple transport tasks with short drive centre distances are described in Chapter 3. Special timing belts for more special transport drives of the product groups optibelt ALPHA V SPECIAL and ALPHA SRP of cast polyurethane are explained in Chapter 6. The optibelt ALPHA V timing belts can be welded together from extruded optibelt ALPHA LINEAR timing belts to achieve the desired length.

For this purpose, the two belt ends of the optibelt ALPHA LINEAR are punched out prior to welding, depending on the profile and the width, in the shape of a finger or cut in the shape of a finger using a water jet, see Figure 5.1.1. After that, the belt ends are inserted together in a toothed mould, which is then closed with a smooth shape. Under pressure and temperature, the belt ends are welded together in the mould. Once the thermoplastic polyurethane has spread, the mould is cooled and the now endlessly connected optibelt ALPHA V is withdrawn.

Due to the high strength of the thermoplastic polyurethane, welded timing belts exhibit, despite the interrupted tensile reinforcement, a permissible connection tensile force in the finger-shaped connection point, which reaches at least 50 % of the permissible tensile reinforcement of a belt with uninterrupted cords.

When welding polyurethane belts with polyamide fabric, the polyamide fabric is not connected at the ends, but forms a joint. In contrast to this, the coatings of reinforced top surfaces, T2, PU-Smart and APL plus, as well as the toothed profile of the belt can be welded without joints.

The basic features or benefits of the welded polyurethane timing belts are:

- Minimum lengths of 400 mm to 1200 mm, depending on width and pitch, available
- Lengths available in pitched steps
- Lengths of over 100 m can also be welded
- Can be delivered at short-notice
- Ideal for transport drives
- PAZ/PAR, polyamide fabric on tooth system and/or belt top surface possible
- Optional PU EU food compliant / FDA
- Designs reinforced top surface, T2, PU-Smart and APL plus weldable without joint
- Direct welding of cleats and V-guides
- Without sleeve nose, profile-dependent, e.g. profile T10

Table 5.1.1: Product group and applications

Transport drives	
ALPHA V	ALPHA V SPECIAL ALPHA SRP
welded endless	welded endless endless
Application examples	
Parallel or synchronous conveyor Inclined conveyor Accumulating conveyor Vacuum conveyor Withdrawal facilities Separator or workpiece positioner	

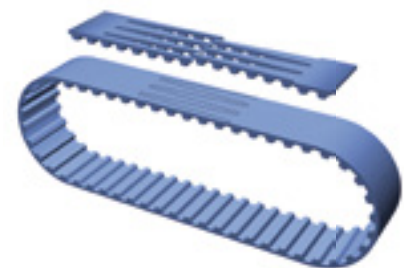

Figure 5.1.1: Punched out belt ends in finger shape and welded optibelt ALPHA V timing belt

5 TRANSPORT DRIVES

5.2 VARIATIONS



5.2 Variations

As an alternative to flanges at the side of the pulleys and/or U-shaped flanks of a support rail at the sides, the lateral guidance of an optibelt ALPHA V conveyor belt can also be achieved by a V-guide on the tooth side. Track timing belts require correspondingly adjusted timing belt pulleys and support rails with keyway. Flanges or flanks that are too high for the transport tasks are not necessary.

Subsequently welded-in V-guides of an optibelt ALPHA V SPECIAL can be positioned in any arrangement over the width regarding number and position. In contrast to these V-guides, integrated V-guides are arranged centrally over the width and notched for a smaller minimum pulley diameter. As the subsequent welding of the V-guide is not necessary, optibelt ALPHA V track timing belts can be offered at comparatively lower prices.

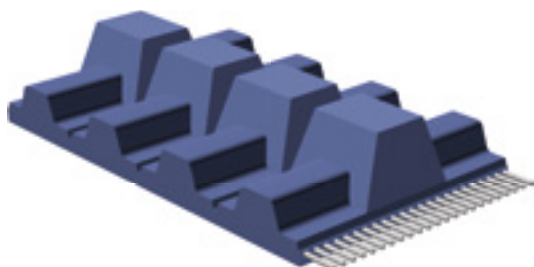

Figure 5.2.1: Polyurethane track timing belt with moulded V-guide

For conveying purposes, optibelt ALPHA V timing belts can be directly produced with a reinforced top surface of polyurethane, see Figure 5.2.2. This is the simplest and hence the most cost-efficient variation on among the coated belt designs of the thermoplastic polyurethane timing belts.

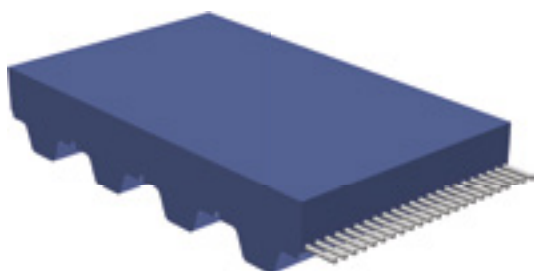

Figure 5.2.2: Polyurethane timing belt of the reinforced top surface design

For the cast optibelt ALPHA SRP timing belt, which is described in Subchapter 6.3, the reinforced polyurethane top surface can alternatively also be designed in hardnesses that differ from the base belt.

Table 5.2.1: Product groups, lengths, profiles and features

optibelt ALPHA V welded, endless	
Minimum length Lengths	400 mm – 1200 mm in indexing steps
Imperial profile	XL, L, H, XH
T profile	T5, T10, T20, TT5
TK profile	T5K6, T10K6, T10K13
AT profile	AT5, AT10, AT20
ATK profile	AT5K6, AT10K6, AT10K13
HTD profile	5M, 8M, 14M, 14ML
Flat belt	F2, F2.5, F3, FL3
Standard colour	white
Standard hardness	92 Shore A
Standard tension cord ¹	steel aramid
PA tooth side, PAZ	+ optional
PA top surface, PAR	+ optional
Special hardness	65, 85 Shore A
Special colour	e. g. black, blue, on request according to RAL No.
Minimum quantity for special hardness, colour	from 200 metres with max. production width
Special tension cord ¹ see Chapter 1.5	highly flexible steel stainless steel
Without sleeve nose	T10, optional
PU (FDA): Hardness, colour	85 Shore A, blue, optionally transparent

¹ Aramid and special cords for each profile on request

5 TRANSPORT DRIVES

5.3 TIMING BELT PRE-SELECTION



Open-ended optibelt ALPHA LINEAR timing belts can be equipped on the belt top surface during production directly with the

- smooth polyurethane coating T2, see Figure 5.2.3 or the
- profiled PU coating, longitudinal fine groove, see Figure in Subchapter 6.2,
- foamed coating PU-Smart, see Figure 5.2.4 or the
- smooth PVC coating APL plus, see Figure 5.2.5,

and welded together with the coating to an endless optibelt ALPHA V.

Subsequent coating is hence not necessary. As a result, these belt design can generally be offered at a lower price than subsequently coated ALPHA V SPECIAL timing belts.

The coatings reinforced top surface, T2, APL plus and PU-Smart can generally be applied on any other base belt, even if the quantities are low.

The features of the above mentioned and subsequently applied coatings for any base belt group beyond polyurethane timing belts are described in Chapter 6.2.

Further details, related to the weldable timing belt and flat belt profiles, listed in Table 5.2.1, are included in Subchapter 1.4.

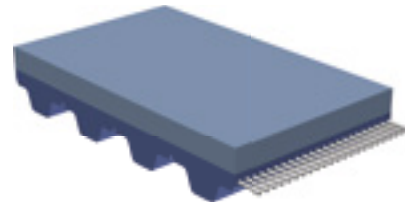

Figure 5.2.3: Polyurethane timing belt with T2 coating, transparent

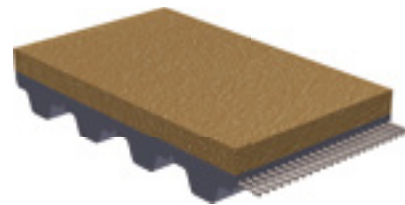

Figure 5.2.4: Polyurethane timing belt with coating PU-Smart brown

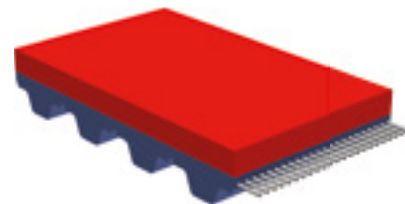

Figure 5.2.5: Polyurethane timing belt with PVC coating APL plus, red

5.3 Timing Belt Pre-selection

Selection of tooth system

The available profiles of the product group ALPHA LINEAR (except ATL profiles) are generally also suitable for use in transport drives and can be welded to optibelt ALPHA V. For the selection of the timing belts, the characteristics of the different timing belt profiles and the pertaining timing belt pulleys should be considered, depending on the transport task. Major characteristics are, for example, the level of the load e.g. by heavy transport goods, ambient conditions such as the contamination through dust and special requirements regarding the positioning accuracy.

5 TRANSPORT DRIVES

5.3 TIMING BELT PRE-SELECTION



The following overview is intended to help with the profile selection for transport drives

AT profiles

- The AT timing belt exhibits the highest tooth shear strength or the highest permissible specific tooth force of all trapezoidal profiles.
- Due to the low tooth deformation of the AT profile, the comparatively strong cords and the comparatively low backlash, high positioning accuracies are achieved.
- In contrast to the other trapezoidal profiles, the tooth is supported on the tooth head area in the tooth gaps of the tooth system of the pulleys.
- A further benefit of the large tooth head of the AT tooth system is the low tooth wear or the higher load bearing capacity of the tooth in conveyor drives due to the reduced surface pressure between belt and supporting rail. In addition, recesses for inserts can be provided which enable detachable connections.

HTD profiles

- The HTD profile is a round curved profile that features a smoother run in comparison with the trapezoidal tooth and a higher skip protection due to the larger tooth height.
- The profile designation stands for "high torque drive". It was developed for highly loaded drives and is used today in new designs primarily for power drives.
- The HTD profile has a large width at the tooth base and hence exhibits a high shear strength and a high permissible specific tooth force. The belt webs between the teeth rest on the tooth heads of the tooth system of the pulleys.
- Due to the round tooth shape and the very small contact area, a high surface pressure is produced at the contact with a support rail in transport applications. For conveyor drives with a high transport load, the HTD profile cannot be recommended, as a result, due to the unfavourable wear behaviour at the tooth head.

T profiles

- The most widely used metric T profile has a trapezoidal shape like the imperial profile. In new designs, this profile is selected for drives that are specifically exposed to low loads.
- Due to the smaller tension cord diameters and the smaller teeth compared to the AT and HDT profiles, the belt is more flexible and can be placed on smaller tooth pulley diameters.
- The backlash and the belt elongation are larger than on the AT timing belt of the same pitch.
- The belt web between the teeth is supported on the tooth heads of the tooth system of the pulleys. In e.g. strongly dust-loaded environments, the larger backlash or the larger clearance between belt and pulley can minimize the tendency to run off the pulley as opposed to the AT profile.

Imperial profiles

- Today, the imperial, trapezoidal profile is hardly used any more in new designs, particularly in the European area. The characteristics basically correspond to those of the T profiles.
- Timing belt drives with imperial profile can be used, after verification, as a replacement solution for imperial transport chain drives.
- Optibelt polyurethane timing belts with an imperial pitch replace chloroprene timing belts with the same pitch where the requirements for chemical resistance are high.

Pre-selection of profile and width

Depending on the selected tooth system, e.g. the AT profile, the following diagrams enable an easy pre-selection of suitable profiles with associated belt widths.

The indicated values F_{allowed} for welded optibelt ALPHA V timing belts refer to the maximum specified tensile forces of the belt at the welded point. The specification tensile force F_{allowed} amounts to 50 % of the specified tensile force of an optibelt ALPHA LINEAR timing belt and its cords.

5 TRANSPORT DRIVES

5.3 TIMING BELT PRE-SELECTION



Diagram 5.3.1: Pre-selection for AT profile and HTD profile with standard steel tension cord

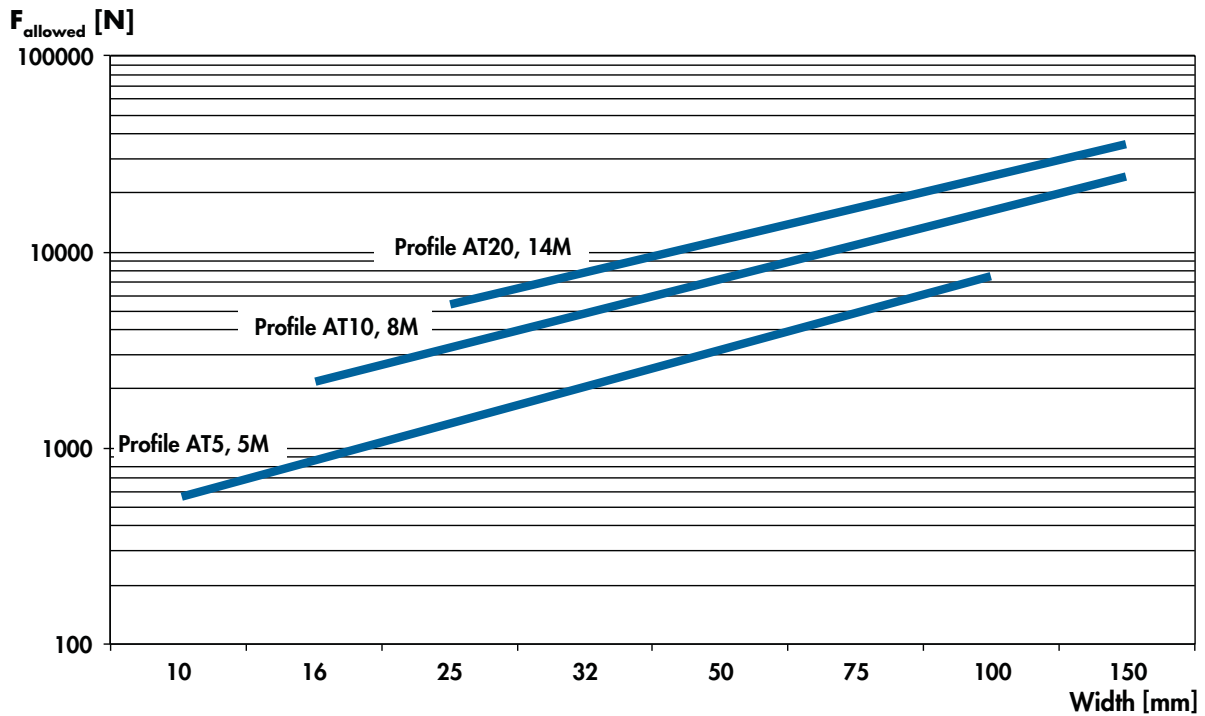
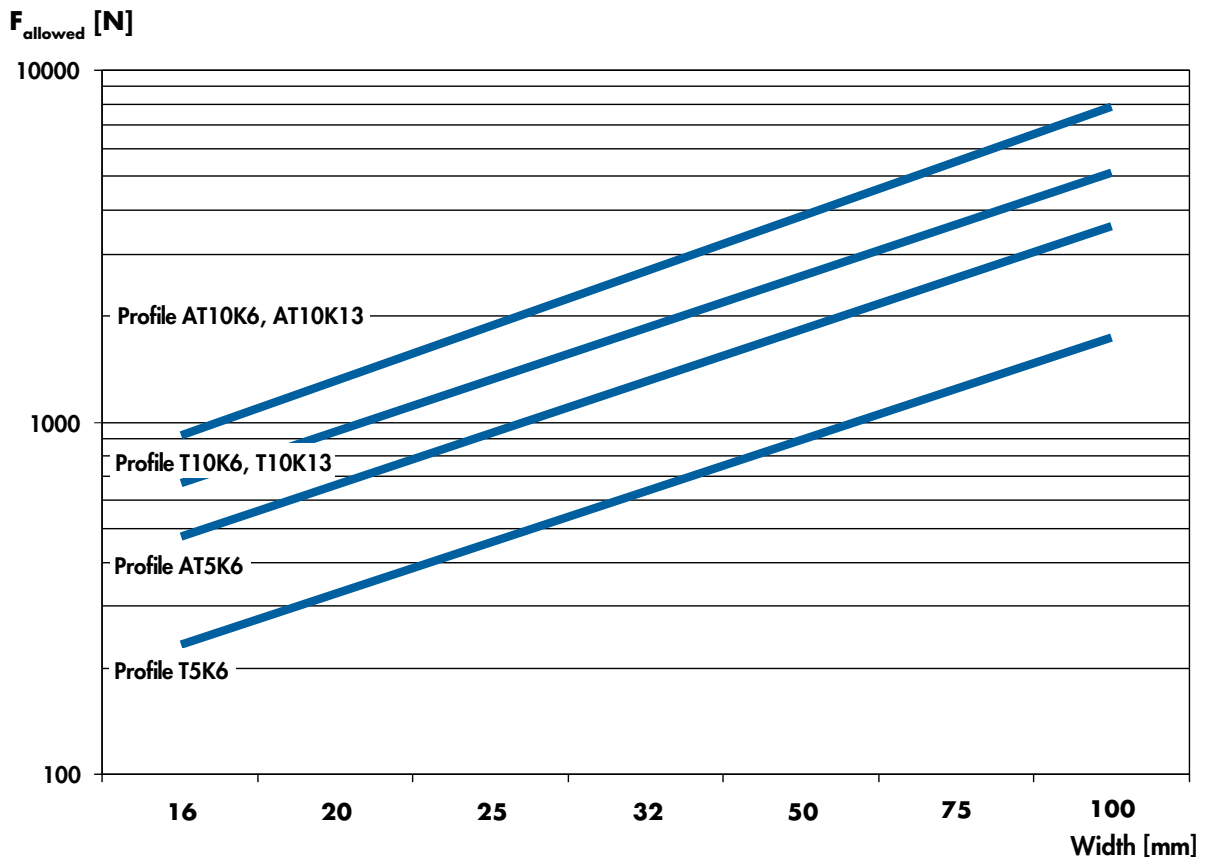

Diagram 5.3.2: Pre-selection for ATK profile and TK profile with standard steel tension cord



5 TRANSPORT DRIVES

5.4 BASICS FOR DRIVE DESIGN



Diagram 5.3.3: Pre-selection for T profile and imperial profile with standard steel tension cord

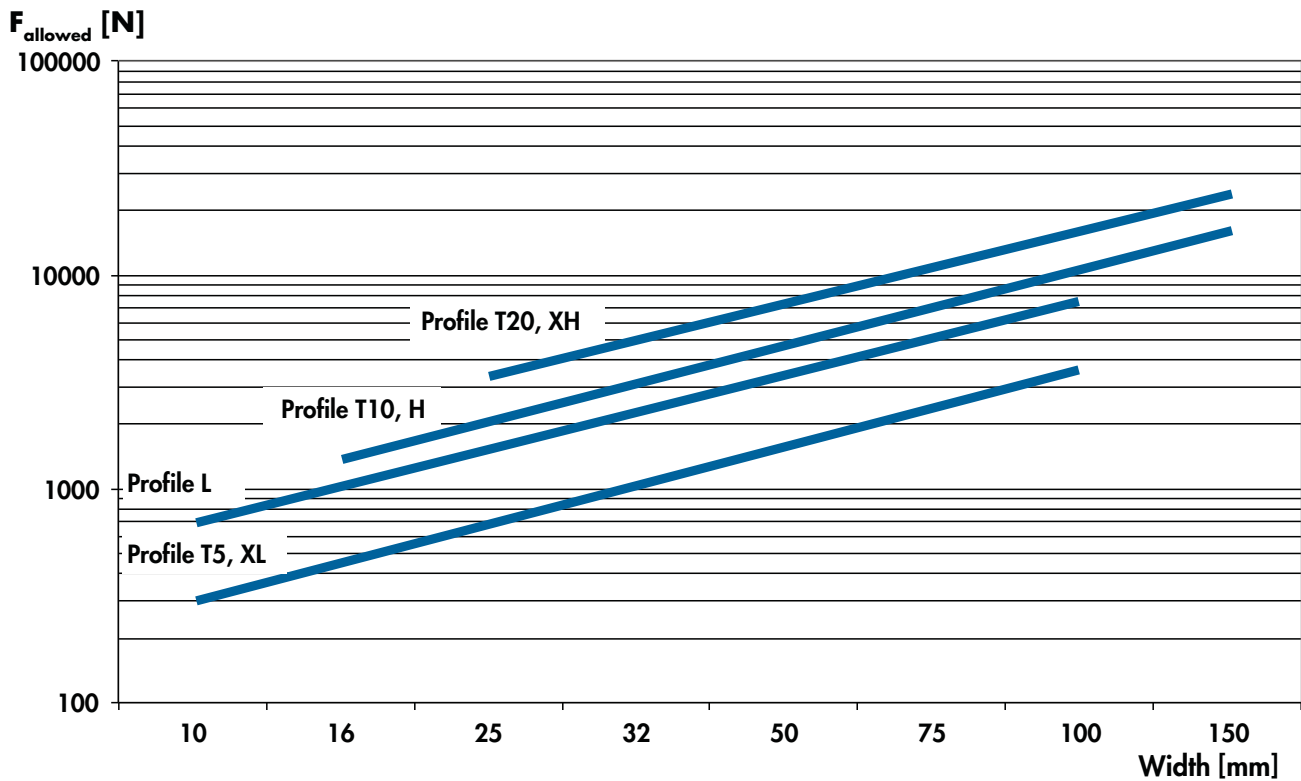

The rated tensile force F_N , which is likewise crucial for an exact drive design of a timing belt and which can be calculated with the aid of the relevant Technical Data Sheet of the profile, refers in contrast to F_{allowed} of the cords of the weaker belt tooth system, especially for high speeds.

5.4 Basics for Drive Design

The general formulas for the basic physical variables such as power P , torque M and circumferential force F_U are included in Subchapter 2.1. In addition, formulas for physical variables such as speed v and acceleration a are supplemented in Subchapter 4.4.

Guide values for drive service factors and allowances are addressed in Subchapter 2.2.

The formula symbols are described in Subchapter 2.3 and listed with their physical units.

5 TRANSPORT DRIVES

5.5 DRIVE DESIGN



5.5 Drive Design

Requirement

In the following calculation example, a mass m is transported in four transport containers on a synchronous conveyor in a horizontal direction. The main load on the transport drive can be derived from the resulting friction forces between the installed steel guide rails and the fabric coating. The electric motor is arranged on the right transfer point. No buffer transport is planned. Small to medium impact loads may occur at the transfer points. Depending on the available installation space, the suitable belt and pulley combination is to be determined through the maximum load.

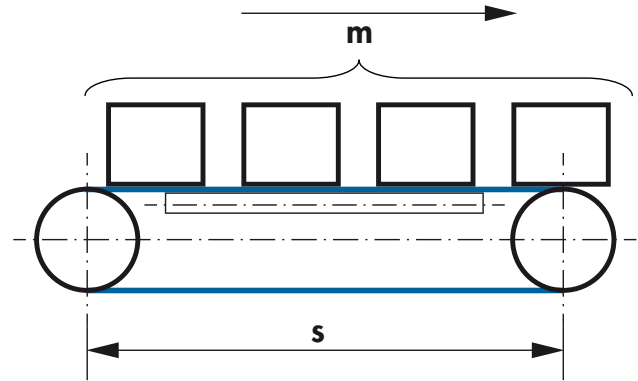

Figure 5.5.1: Transport drive, horizontal arrangement, $d_{w1} = d_{w2}$

The following values are given:

Mass transport goods per container $m_1 = 25$ kg

Mass container $m_2 = 5$ kg

Base area of the container L x W: 300 x 400 mm

Centre distance of belts approx.: 250 mm

Transport velocity $v = 0.4$ m/s

Angle of inclination $\alpha = 0^\circ$

Overall height: Diameter $d_{max} < 70$ mm, $d_{w1} = d_{w2}$

Conveying distance $s = 2500$ mm

Transfer length per side: 50 mm

Coating: 2 mm NG red

Starts: 1-2 per day

Operating time: 18 h/day

Ambient conditions: Room temperature, no influence of harmful substances, chemicals and radiation

Calculation methods

The drive design is achieved through the calculation of the circumferential force F_U . The basis for this is

- the drive torque load M_N of the driving machine and
- the friction forces in the transport side.

If, as in this example, the calculation method by the friction forces is selected, the selected driving machine must subsequently be included in the drive design.

The calculation circumferential force F_{BU} and the design torque M_{BN} consider all loads acting on the belt.

Calculation circumferential force F_{BU} through the drive torque M_N

The calculation method is shown here without a calculation example. One example can be found in Subchapter 3.5 where concrete specifications for the drive torques of the motor are shown.

The design can be made through the acting drive torque M_N and the calculation drive torque M_{BN} .

$$M_{BN} = \frac{c_2 \cdot M_N}{\text{Number of belts}} \quad [\text{Nm}] \quad \text{with } M_N [\text{Nm}]$$

5 TRANSPORT DRIVES

5.5 DRIVE DESIGN



The total drive service factor c_2 is composed of the type of base drive service factor, the additional loads by pulleys and the starting frequency, see Subchapter 2.2. The preliminary design circumferential force results from the intended and estimated diameter of the timing belt pulleys which can be derived e.g. from the specification for the installation space. In a recalculation, the precise diameter is inserted here, of course.

$$F_{BU} = M_{BN} \frac{2 \cdot 10^3}{d_w} \quad [\text{N}] \quad \text{with } M_{BN} [\text{Nm}], d_w [\text{mm}]$$

If the design circumferential force F_{BU} is already determined, the procedure can start directly with the preselection of the belt.

Design circumferential force F_{BU} through friction forces

For the determination of the circumferential force by the friction forces, the acceleration forces can usually be ignored. However, this does not apply e.g. to conveyors with a continuous start/stop operation. Here, the determination of the design circumferential force of a linear drive can be considered, see Subchapter 4.5.

In the case of a very light transport mass, the occurring circumferential forces are very low. In this case, a design directly using the geometric requirements of the transport goods and the transport drive is possible. The design can start with the profile below on belt pre-selection of profile and width.

The mass m to be considered for the drive design is here composed of the mass of the transport goods m_1 , the mass of the transport container m_2 and the number of containers, in this case four.

In the case of a high starting frequency and hence frequent accelerations, the belt mass and the moment of mass inertia of the second timing belt pulley which is also moved act as additional loads. This is usually much smaller than the force to transport the mass and can therefore be ignored in most cases. The total drive service factor c_0 then also covers these subordinated forces. Only for very long distances of movement and large, heavy pulleys, must this mass or moments of mass inertia be included precisely.

$$m = \text{number} \cdot (m_1 + m_2) \quad [\text{kg}] \quad \text{with number [-], } m_1 [\text{kg}] \text{ and } m_2 [\text{kg}]$$

$$m = 4 \cdot (5 \text{ kg} + 25 \text{ kg}) = 120 \text{ kg}$$

The circumferential force F_U corresponds to the friction force between belt and support rail, which depends, in addition to the mass, on the coefficient of friction μ , see Table 6.1, of the materials. The normal force F_N , which acts on the belt, corresponds in a horizontal direction to the full weight force, see also Table 2.1.6. For buffer conveyors, the coefficient of friction μ_1 must also be considered. As no buffer transport is planned here, $\mu_1 = 0$.

$$F_U = m \cdot (\mu_1 + \mu_2) \cdot g \cdot \cos \alpha \quad [\text{N}] \quad \text{with } m [\text{kg}], \mu [-] \text{ from Table 6.1, } g [\text{m/s}^2], \alpha [^\circ]$$

$$F_U = 120 \text{ kg} \cdot (0 + 0.4) \cdot 9.81 \frac{\text{m}}{\text{s}^2} \cdot \cos 0^\circ = 470.9 \text{ N}$$

5 TRANSPORT DRIVES

5.5 DRIVE DESIGN



The calculation circumferential force F_{BU} considers the total drive service factor c_2 and the external load per belt. The total drive service factor c_2 is composed of the type of the base drive service factor c_0 , the additional loads on pulleys c_6 and the starting frequency c_8 , see Subchapter 2.2.

$$c_2 = c_0 + c_6 + c_8 \quad \text{see Tables 2.2.1 and 2.2.2}$$

$$c_2 = 1.7 + 0 + 0.1 = 1.8$$

c_0 : selected, for medium drive, mean impact load for transfer

c_6 : two-pulley transport drive

c_8 : low starting frequency and low starting load assumed

$$F_{BU} = \frac{c_2 \cdot F_U}{\text{Number of belts}} \quad [\text{N}] \quad \text{with } c_2 [-] \text{ and } F_U [\text{N}]$$

$$F_{BU} = \frac{1.8 \cdot 470.9 \text{ N}}{2} = 423.8 \text{ N}$$

Selection of tooth system

As the tooth system of the AT profile exhibits, in comparison, the lowest tooth wear or the maximum tooth load bearing capacity in transport drives due to the reduced surface pressure between belt and supporting rail, the AT profile is selected.

Belt pre-selection of profile and width

According to Diagram 5.3.1 two pieces of optibelt ALPHA LINEAR 25 AT5-ST are selected. The overall height h is 2.7 mm and enables, in contrast to T5 profile with an overall height of only 2.2 mm, a better lateral guidance due to the side flanks of the support rails. This difference in the overall height of the trapezoidal optibelt ALPHA V timing belts only applies to the pitch of 5 mm, not to the pitches of 10 mm and 20 mm.

After the belt preselection, the occurring surface pressure σ between tooth head and support rail, depending on the weight, must be determined for each transport unit and belt.

With an increasing relative speed, the tooth head abrasion increases and the permissible surface pressure decreases accordingly.

$$\sigma_{\text{allowed}} \leq 0.5 \frac{\text{N}}{\text{mm}^2} \quad \text{simplified guide value for } v = 0.5 \text{ m/s}$$

Further influencing factors are additionally the surface roughness of the support rail, the ambient temperature and the influence of substances that have an impact on the friction.

Under ideal conditions and at low belt speeds $v < 0.1 \text{ m/s}$, the indicated guide value can be exceeded. For belt speeds of 1 m/s, the guide value should be lower.

$$\sigma = \frac{F_N}{A} \quad \left[\frac{\text{N}}{\text{mm}^2} \right] \quad \text{with } F_N [\text{N}] \text{ and } A [\text{mm}^2]$$

$$\sigma = \frac{147.15 \text{ N}}{3750 \text{ mm}^2} = 0.04 \frac{\text{N}}{\text{mm}^2} \leq 0.5 \frac{\text{N}}{\text{mm}^2} \quad \text{hence the condition } \sigma \leq \sigma_{\text{allowed}} \text{ is fulfilled}$$

5 TRANSPORT DRIVES

5.5 DRIVE DESIGN



Normal force F_N see formulas in Table 2.1.6, here:

$$F_N = \frac{(m_1 + m_2) \cdot g \cdot \cos \alpha}{\text{Number of belts}} \quad [\text{N}] \quad \text{with } m \text{ [kg], } g \text{ [m/s}^2\text{] and } \alpha \text{ [}^\circ\text{]}$$

$$F_N = \frac{(5 \text{ kg} + 25 \text{ kg}) \cdot 9.81 \frac{\text{m}}{\text{s}^2} \cdot \cos 0^\circ}{2} = 147.15 \text{ N}$$

Bearing teeth head area A with pitch t and tooth head width see e.g. Optibelt product range list and belt width b :

$$A = \frac{\text{Transport box length}}{t} \cdot b \cdot \text{tooth head width} \quad [\text{mm}^2] \quad \text{with units [mm]}$$

$$A = \frac{300 \text{ mm}}{5 \text{ mm}} \cdot 25 \text{ mm} \cdot 2.5 \text{ mm} = 3750 \text{ mm}^2$$

Calculation of the belt and pulley geometry

The selection of the pulley diameter, related to maximum values, is primarily determined by the existing installation and dismantling space. The belt height is indicated e.g. in the relevant Technical Data Sheet. The outside diameter d_o of the selected timing belt pulley or the diameter of the existing flange D_B , is indicated e.g. in the Optibelt product range list. Here, the associated hub and tooth widths or the timing belt pulley designs are shown as well. In transport drives, the thickness of a coating, or the height or the welding thickness of a cleat if present determines the maximum timing belt pulley diameter, related to the maximum installation space, see Chapter 6.

The selection of the pulley diameter, related to minimum values, is determined by the required shaft diameter and the shaft/hub connection, see product range list. The major features of the shaft/hub connections are detailed in Subchapter 7.2.

By selecting the belt profile and its technical design, the associated minimum number of teeth z_{\min} and the minimum pulley diameter $d_{w\min}$ of the timing belt pulley are defined, see Technical Data Sheet. The minimum pulley diameter for belts with steel cord are additionally shown in Subchapter 7.3 and Table 7.3.4. For a first estimate, they can be seen in a simplified way in the Optibelt product range list.

In transport drives, the thickness of a coating or cleat, if present, determines additionally the recommended minimum pulley diameter, see Subchapters 6.2 and 6.4.

The selected number of teeth of a standard pulley is indicated in the product range list. As an alternative and for special timing belt pulleys, the number of teeth z is calculated based on the profile of pitch t of the selected belt profile and the intended pulley diameter.

The preliminary effective diameter is defined in this example with $d_w = 50 \text{ mm}$.

$$z = \frac{d_w \cdot \pi}{t} = z_1 = z_2 \quad [-] \quad \text{with } d_w \text{ [mm]} < d_{\max}, t \text{ [mm]} \text{ depending on profile}$$

$$z_1 = \frac{50 \text{ mm} \cdot \pi}{5 \text{ mm}} = 31.416 \quad \text{selected } z = 32 \quad z_1 > z_{\min} = 12 \quad \text{see Technical Data Sheet}$$

$$d_w + 2 \cdot h \text{ or } D_B + 2 \cdot h = 54 \text{ mm} + 2 \cdot 2.7 \text{ mm} = 59.4 \text{ mm} < 70 \text{ mm}$$

From the standard product range, the next standard timing belt pulley optibelt ZRS 36 AT5/32 - 2 with a number of teeth of $z = 32$, an effective diameter $d_w = 50.94 \text{ mm}$ and two flanges with a diameter $D_B = 54 \text{ mm}$ is selected.

5 TRANSPORT DRIVES

5.5 DRIVE DESIGN



The minimum required diameter of the pulley of 40 mm at a coating thickness of 2 mm is fulfilled with the selected pulley, see also Subchapter 6.2.

The timing belt must be protected on both sides against off-track running from the pulleys e.g. by means of support rails or flanges.

Should flanges be used, it must be checked if the excess coating height h_{SB} is sufficient to prevent a contact of the transport box with the flanges at the transfer stations. This depends on the coating thickness s on the timing belt with the height h and the tooth height h_t and the flange diameter D_B .

$$h_{SB} = \frac{(d_a + 2 \cdot (s + (h - h_t)) - D_B)}{2} \quad [\text{mm}] \quad \text{with } d_a \text{ [mm], } s \text{ [mm], } h \text{ [mm], } h_t \text{ [mm], } D_B \text{ [mm]}$$

$$h_{SB} = \frac{(49.7 \text{ mm} + 2 \cdot (2 \text{ mm} + (2.7 \text{ mm} - 1.2 \text{ mm})) - 54 \text{ mm})}{2} = 1.35 \text{ mm}$$

With a flat design of the lower transport box side, a standard pulley with flanges could be used here. However, over the service life, an increasing wear of the coating must be assumed so that a design without flanges is recommended.

If timing belt pulleys without flanges are used, a lateral guidance of the belt through flanks in the support rail must be provided, see also generally Subchapter 7.3.

Rated tensile force

In the Technical Data Sheet of the selected belt, see Subchapter 5.7, the exact permissible tensile forces F_{allowed} for the individual widths from Diagrams 5.3.1 to 5.3.3 of the pre-selection for profile and width are indicated again.

$F_{BU} < F_{\text{allowed}}$ For the endless welded timing belt optibelt ALPHA V 25 AT5-ST, accordingly $F_{\text{allowed}} = 775 \text{ N}$. The condition mentioned here is fulfilled with $F_{BU} = 266.8 \text{ N}$.

The rated tensile force F_N refers to the tooth system of the belt. The load bearing capacity of the tooth flanks is reduced with increasing speed n . This is shown in the table of the Technical Data Sheet with the title "Specific nominal tensile force transmittable per tooth". The rated tensile force F_N can be calculated, as indicated in the Technical Data Sheet or in Table 2.1.3, additionally from the belt width b and the calculation tooth number z_{eB} . This results from the engaging number of teeth z_e , which is limited to $z_{eB \text{ max}} = 6$ for welded belts, see also Table 2.1.2:

$$F_N = F_{N \text{ spec}} \cdot z_{eB} \cdot b \quad [\text{N}] \quad \text{with } F_{N \text{ spec}} \text{ [N/mm] from Technical Data Sheet interpolated, } z_{eB} \text{ [-] and } b \text{ [mm]}$$

$$F_N = 3.321 \frac{\text{N}}{\text{mm}} \cdot 6 \cdot 25 \text{ mm} = 498.2 \text{ N}$$

$$n = \frac{19.1 \cdot 10^3 \cdot v}{d_w} \quad \left[\frac{1}{\text{min}} \right] \quad \text{with } v \left[\frac{\text{m}}{\text{s}} \right], d_w \text{ [mm]}$$

$$n = \frac{19.1 \cdot 10^3 \cdot 0.4 \frac{\text{m}}{\text{s}}}{50.94 \text{ mm}} = 150 \frac{1}{\text{min}}$$

Engaging number of teeth with $z_1 = z_2$, see also Table 2.1.2:

$$z_e = \frac{z_1}{2} \quad z_{eB} = z_e \quad \text{and} \quad z_{eB} \leq z_{e \text{ max}} \quad \text{with } z_{e \text{ max}} = 6 \text{ for optibelt ALPHA V}$$

$$z_e = \frac{32}{2} = 16 \quad z_{eB} = 6$$

5 TRANSPORT DRIVES

5.5 DRIVE DESIGN



The existing safety factor $c_{2\text{actual}}$, related to the load on the tooth system, is:

$$c_{2\text{actual}} = \frac{F_N \cdot \text{number of belts}}{F_U} \quad [-] \quad \text{with } F_N \text{ [N]}, F_U \text{ [N]} \text{ and } c_{2\text{actual}} \geq c_2$$

$$c_{2\text{actual}} = \frac{498.2 \text{ N} \cdot 2}{470.9 \text{ N}} = 2.12 \quad \geq 1.8$$

Optionally the required width b_{th} can be determined.

$$b_{\text{th}} = b \cdot \frac{c_2}{c_{2\text{actual}}} \quad [\text{mm}] \quad \text{with } b \text{ [mm]}, c_2 \text{ [-]} \text{ and } c_{2\text{actual}} \text{ [-]}$$

$$b_{\text{th}} = 25 \text{ mm} \cdot \frac{1.8}{2.12} = 21.3 \text{ mm}$$

If the required width b_{th} is slightly higher than the next smallest standard width of the selected timing belts and timing belt pulleys, a reduction of the selected total drive service factor c_2 to a still acceptable smaller value should be considered. This helps to avoid unnecessary costs, if desirable.

For a drive torque led design, the required width – as far as this is permitted e.g. by the installation space – can be reduced by an increased pulley diameter.

Static and maximum belt tension

The formula for the calculation of the static belt tension F_T is indicated in Table 2.1.7 in Subchapter 2.1; it applies to transport drives depending on the length of the unloaded span side or the arrangement of the drive.

$$F_T = \frac{0.5 \cdot c_v \cdot F_U}{\text{Number of belts}} \quad [\text{N}] \quad \text{with } F_U \text{ [N]} \text{ and } c_v \text{ [-]} \text{ and with front drive}$$

$$F_T = \frac{0.5 \cdot 1.0 \cdot 470.9 \text{ N}}{2} = 117.75 \text{ N}$$

In this example, a front drive is specified. The belt tension factor c_v is 1.0, as the calculated total drive service factor $c_2 \leq 2.5$. In the case of a clear over-dimensioning e.g. $c_2 \geq 2.5$, an increase of the belt tension is recommended. This generally applies also to very large drive centre distances, see Subchapter 2.1. Alternatively, the following applies from Table 2.1.7:

$$c_v \geq \frac{c_2 - 1}{10} + 1 \quad [-] \quad \text{with } c_2 \text{ [-]}$$

The cords used in the optibelt ALPHA V timing belts in technical standard designs are selected generally consistently with the tooth system and the maximum possible rated tensile force and do therefore not require any additional verification for the design of a transport drive through the determination of F_{max} and the alignment with F_{allowed} .

As an exemption, this is only required, if a transport drive with front drive generally moves only one single mass so that the loaded span side can become very short temporarily. In addition, a low speed and a low total drive service factor $c_2 \leq 1.3$ must have been selected.

For this rare case – and therefore only indicated for reasons of completeness – the following applies:

$$F_{\text{max}} = F_T + \frac{F_U}{\text{Number of belts}} \quad [\text{N}] \quad \text{with } F_T \text{ [N]}, F_U \text{ [N]} \quad \text{The following applies: } F_{\text{max}} \leq F_{\text{allowed}}$$

5 TRANSPORT DRIVES

5.5 DRIVE DESIGN



As an example:

$$F_{\max} = 117.75 \text{ N} + \frac{470.9 \text{ N}}{2} = 353.2 \text{ N}$$

With $F_{\text{allowed}} = 775 \text{ N}$, see Technical Data Sheet for the optibelt ALPHA V 25 AT5-ST, the above condition would also be fulfilled with a concentration of the mass on only one single transport box.

For high requirements regarding the stepping and positioning accuracy, this can be determined in a simplified way through the elastic elongation of the selected timing belt. The calculation method and further explanations about the positioning accuracy for a single mass can be found in Chapter 4 to linear drives.

Static shaft loading

$$F_{\alpha \text{ sta}} = 2 \cdot F_T \quad [\text{N}] \quad \text{per belt with } F_T \text{ [N]}$$

$$F_{\alpha \text{ sta}} = 2 \cdot 117.75 \text{ N} = 235.5 \text{ N} \quad \text{per belt}$$

In the case which is described above, the dynamic shaft loading can, temporarily be $2 F_T + F_U$.

Belt length and order designations

$$L_w = 2 \cdot a + z \cdot t \quad [\text{mm}] \quad \text{with } a \text{ [mm], } z \text{ [-] and } t \text{ [mm]}$$

$$\text{with } a = s + 2 \cdot \text{transfer length} = 2500 \text{ mm} + 2 \cdot 50 \text{ mm} = 2600 \text{ mm}$$

$$L_w = 2 \cdot 2600 \text{ mm} + 32 \cdot 5 \text{ mm} = 5360 \text{ mm}$$

Since the requirements for the transport drive are now met, the order designations for belts and pulleys are:

2 pcs. optibelt ALPHA V SPECIAL 25 AT5/5360-ST with 2 mm NG red

4 pcs. optibelt ZRS 36 AT5/32-0

Depending on the shaft/hub connection of the drive pulleys and the bearing of the two guide pulleys, they can also be ordered as special pulleys without flanges.

Belt tension adjustment through frequency measurement

The specification for the adjustment of the static belt tension through frequency measurement can be calculated depending on the freely oscillating span length L and the weight per metre m_K of the selected belt. Further information about frequency measurement are indicated in Chapter 7.1. Figure 5.5.2 shows that with increasing span length L the natural frequency f drops.

Also in a transport drive, a specified value, for example, for the frequency $f \geq 10 \text{ Hz}$ must be obtained if possible (refer to the measuring range of the optibelt TT series measuring instrument).

As described in Subchapter 7.1, the frequency f cannot be measured in the example below, since

- the span length is larger than 1000 mm and therefore the frequency, is below 10 Hz,
- presumably the coating has a dampening effect on free oscillation.

To confirm this assumption, the frequency is here determined in a simplified manner for an uncoated belt.

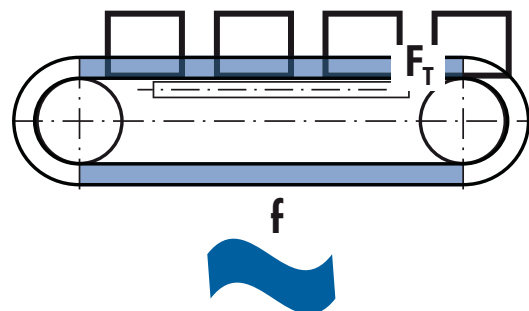

Figure 5.5.2: Belt tension adjustment through frequency measurement

5 TRANSPORT DRIVES

5.5 DRIVE DESIGN



$$f = \sqrt{\frac{F_T \cdot 10^6}{4 \cdot m_k \cdot L^2}} \quad [\text{Hz}]$$

with F_T [N], m_k $\left[\frac{\text{kg}}{\text{m}}\right]$ or $\left[\frac{\text{g}}{\text{mm}}\right]$, L [mm]

$$f = \sqrt{\frac{117.75 \text{ N} \cdot 10^6}{4 \cdot 0.083 \frac{\text{kg}}{\text{m}} \cdot (2600 \text{ mm})^2}} = 7.24 \text{ Hz}$$

m_k of Technical Data Sheet

This means that depending on the measuring range of the optibelt TT series measuring instrument it is not possible to obtain a reasonable frequency measurement here. As a result, the belt tension must be determined by measuring the elongation.

Belt tension adjustment through measurement of the elongation

The belt tension adjustment through measurement of the elongation does generally not achieve the accuracy of the belt tension adjustment through the measurement of the natural frequency of a freely oscillating span side. The belt tension adjustment through the measurement of the elongation is described in Chapter 7.1.

Generally applicable maximum guide values for the static span elongation ε_{FT} of transport drives with front or rear drive:

Guide value $\varepsilon_{FT} \leq 0.1\%$ for front drives

Guide value $\varepsilon_{FT} \leq 0.15\%$ for rear drives

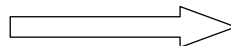

$\varepsilon_{FT} \leq 0.1\%$
simplified consistent
maximum guide value

In practice, transport drives with safety factor values > 1.5 are designed so that a consistent, simplified guide value for the static span elongation ε_{FT} of all transport drives with optibelt ALPHA V timing belts can be assumed. For transport drives equipped with optibelt ALPHA TORQUE/POWER, ALPHA SRP and ALPHA FLEX timing belts, usually the double values apply.

With a drive centre distance $a = 2600$ mm or a marked span length $L_V = 2600$ mm, a shaft can be moved or stretched by the belt tension length $x_V \leq 2.6$ mm, e. g. 2.0 mm or the span side by the elongation $\Delta L_V \leq 2.6$ mm, e. g. 2.0 mm, from the unloaded condition for tensioning, see Figure 5.5.3. The larger the span length, the higher the accuracy of the adjustment the unloaded condition.

The precise belt tension length x_V , related to the shafts, or the precise elongation ΔL_V , related to a marked length L_V of a previously unloaded span side under the static belt tension F_T , results from the respective spring rigidity of the base belt. This can be assumed for simplification also for special belts with coating or cleats.

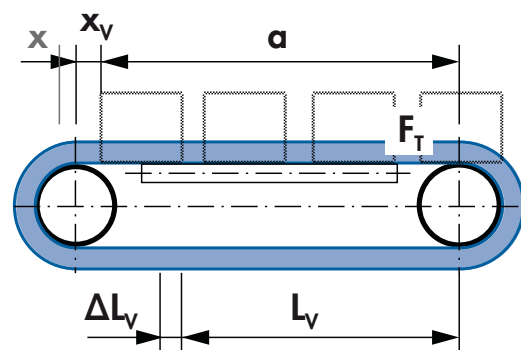

Figure 5.5.3: Belt tension adjustment through the measurement of the elongation ΔL_V

5 TRANSPORT DRIVES

5.5 DRIVE DESIGN



$$x_v = \varepsilon_{FT} \cdot a \quad [\text{mm}] \quad \text{with } \varepsilon_{FT} [\%], a [\text{mm}] \quad \text{or } \Delta L_v = \varepsilon_{FT} \cdot L_v \quad [\text{mm}] \quad \text{with } \varepsilon_{FT} [\%], L_v [\text{mm}]$$

$$x_v = 0.000357 \cdot 2600 \text{ mm} = 0.93 \text{ mm}$$

$$\varepsilon_{FT} = \frac{F_T}{c_{\text{spec}}} \quad [\%] \quad \text{with } F_T [\text{N}], c_{\text{spec}} [\text{N}] \quad \text{here}$$

$$\varepsilon_{FT} = \frac{117.75 \text{ N}}{329788 \text{ N}} = 0.000357 = 0.036 \%$$

$$c_{\text{spec}} = \frac{F_{\text{allowed ALPHA V}}}{\varepsilon_{\text{allowed ALPHA LINEAR}}} \cdot 2 \quad [\text{N}] \quad \text{with } F_{\text{allowed ALPHA V}} [\text{N}], \varepsilon_{\text{allowed ALPHA LINEAR}} [\%] \text{ of Table 4.5.1}$$

$$c_{\text{spec}} = \frac{775 \text{ N}}{0.47\%} \cdot 2 = 329788 \text{ N} \quad \text{to } c_{\text{spec}} \text{ see 5.6 Technical Data Sheet}$$

The more precise value for the permissible elongation $\varepsilon_{\text{allowed}}$ of an optibelt ALPHA LINEAR to the formula above – not for optibelt ALPHA V with half as big values – is indicated in Table 4.5.1 and the respective profile, here the AT5 profile with $\varepsilon_{\text{allowed}} = 0.47 \%$ in the standard cord design ST. For simplification, all profiles and designs can be calculated with $\varepsilon_{\text{allowed}} = 0.5 \%$.

For the whole belt length $L_w = L_v = 5360 \text{ mm}$. Likewise, the following applies here to the elongation ΔL_v :

$$\Delta L_v = \varepsilon_{FT} \cdot L_v \quad [\text{N}] \quad \text{with } \varepsilon_{FT} [\%], L_v [\text{mm}]$$

$$\Delta L_v = 0.000357 \cdot 5360 \text{ mm} = 1.91 \text{ mm}$$

Allowances for tensioning and fitting

Subchapter 7.5 contains general information about the allowances and Table 7.5.2 contains formulas and supplementary guide values for the minimum allowances.

The allowance x for an individual shaft to tension the optibelt ALPHA V timing belt can be determined in a simplified way:

$$x = 0.0020 \cdot a \quad [\text{mm}] \quad \text{with } a [\text{mm}]$$

$$x = 0.0020 \cdot 2600 \text{ mm} = 5.2 \text{ mm}$$

The allowance y of a single shaft for fitting an open-ended optibelt ALPHA V timing belt can be derived for a drive with timing belt pulleys without flanges as follows:

$$y = 0.0005 \cdot a \quad [\text{mm}] \quad \text{with } a [\text{mm}]$$

$$y = 0.0005 \cdot 2600 \text{ mm} = 1.3 \text{ mm}$$

If the allowance x to be provided must be minimised, the following more precise formulas can be used. Using these, the belt tension x_v , which results from the elastic elongation with the static belt tension F_T , the maximum possible positive length tolerance per meter $L_{\text{tol}+}$ and the total length L_w are considered.

The length tolerance can be seen on the relevant Technical Data Sheet or Subchapter 7.4. For optibelt ALPHA V timing belts in technical standard design with standard steel cord ST this is consistently $\pm 0.5 \text{ mm/m}$ and accordingly in the positive range $L_{\text{tol}+} = 0.5 \text{ mm/m}$. This then corresponds to an elongation $\varepsilon_{L_{\text{tol}+}} = 0.0005$ or 0.05% .

5 TRANSPORT DRIVES

5.5 DRIVE DESIGN



Generally the following applies:

$$x_{L_{tol+}} = \varepsilon_{L_{tol+}} \cdot \frac{L_w}{2} \quad [\text{mm}] \quad \text{with } \varepsilon_{L_{tol+}} [\%] \text{ and } L_w [\text{mm}]$$

$$x_{L_{tol+}} = 0.0005 \cdot \frac{5360 \text{ mm}}{2} = 1.34 \text{ mm}$$

$$\varepsilon_{L_{tol+}} = \frac{L_{tol+}}{1000} \quad [\%] \quad \text{with } L_{tol+} [\text{mm/m}]$$

$$\varepsilon_{L_{tol+}} = \frac{0.5 \text{ mm/m}}{1000} = 0.0005 = 0.05 \%$$

If the formulas are directly inserted for the elongations and span lengths, the following applies:

$$x = \left(\frac{F_T}{F_{\text{allowed}}} \cdot \varepsilon_{\text{allowed}} + \frac{L_{tol+}}{1000} \right) \cdot \frac{L_w}{2} \quad [\text{mm}]$$

$$x = \left(\frac{117.75 \text{ N}}{775 \text{ N}} \cdot 0.0047 + \frac{0.5 \text{ mm/m}}{1000} \right) \cdot \frac{5360 \text{ mm}}{2} = 3.25 \text{ mm}$$

5 TRANSPORT DRIVES

5.6 TECHNICAL DATA SHEET



5.6 Technical Data Sheet

The information from the Technical Data Sheets of the product groups optibelt ALPHA TORQUE, ALPHA POWER, ALPHA FLEX and ALPHA V timing belts, further data from this Technical Manual and the current Optibelt product range list can be used to design transport drives.

In Subchapter 5.5, this is done generally and according to the example of an optibelt ALPHA V timing belt with the AT5 profile of the ST standard design.

The relevant up-to-date Technical Data Sheets are available on the website www.optibelt.com. There, you can download the optibelt CAP software for drive design of power drives free of charge and to obtain further current information about services and products.

Technical Data Sheet

optibelt ALPHA LINEAR / V AT5 - ST

Polyurethane Timing Belt, Optionally With Fabric PAZ/PAR, Thermoplastic PU, Open-Ended / Endless Joined



Dimensions, Tolerances

Profile:	AT5
Tooth pitch t:	5 mm
Total thickness:	2.7 mm
Tooth height:	1.2 mm
Tooth tip width:	2.5 mm
Tooth flank angle:	50°
Length tolerance:	±0.5 mm/m
Width tolerance:	±0.5 mm
Thickness tolerance:	±0.30 mm

Construction

Polyurethane:	Thermoplastic, 92 Shore A, white
Tension cord:	Steel, Ø 0.5 mm
Fabric, optional:	Polyamide, tooth and back (PAZ/PAR), green

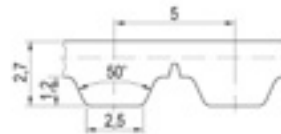

Specific nominal tensile force transmittable per tooth

Input speed n_1 [1/min]	Spec. nom. tensile force $F_{N\ spez}$ [N/mm]	Input speed n_1 [1/min]	Spec. nom. tensile force $F_{N\ spez}$ [N/mm]	Input speed n_1 [1/min]	Spec. nom. tensile force $F_{N\ spez}$ [N/mm]
0	3.600	1200	2.478	3600	1.814
20	3.555	1300	2.433	3800	1.779
40	3.513	1400	2.391	4000	1.746
60	3.473	1500	2.351	4500	1.670
80	3.435	1600	2.314	5000	1.601
100	3.399	1700	2.278	5500	1.538
200	3.243	1800	2.244	6000	1.481
300	3.116	1900	2.212	6500	1.427
400	3.009	2000	2.181	7000	1.378
500	2.916	2200	2.123	7500	1.332
600	2.834	2400	2.070	8000	1.289
700	2.761	2600	2.020	8500	1.248
800	2.694	2800	1.973	9000	1.210
900	2.634	3000	1.930	9500	1.173
1000	2.578	3200	1.889	10000	1.139
1100	2.526	3400	1.850	$v_{max} = 80$ m/s	

Nominal tensile force F_N

$$F_N = F_{N\ spez} \cdot z_{eB} \cdot b \quad [N]$$

$F_{N\ spez}$ Specific nominal tensile force transmittable per tooth [N/mm]
 z_{eB} Number of teeth in mesh, driver pulley, limited to $z_{eB\ max}$
 $z_{eB\ max}$ ALPHA LINEAR: 12, ALPHA V: 6
 b Belt width [mm]

Nominal torque M_N

$$M_N = F_N \cdot d_{w1} / (2 \cdot 10^3) \quad [Nm]$$

$$d_{w1} = z_1 \cdot t / \pi \quad [mm]$$

d_{w1} Pitch diameter, driver pulley [mm]
 z_1 Number of teeth, driver pulley
 t Tooth pitch [mm]

Nominal power P_N

$$P_N = F_N \cdot z_1 \cdot t \cdot n_1 / (6 \cdot 10^7) \quad [kW]$$

n_1 Speed, driver pulley [1/min]

Cord tensile force, minimum belt length, belt weight

Belt width ¹ b [mm]	10	16	20	25	32	50	75	100
F_{Br} [N], ALPHA LINEAR	2560	3680	5120	6240	8240	13960	21920	29920
F_{zul} [N] ² , ALPHA LINEAR, $\epsilon_{zul}=0,47\%$	640	920	1280	1560	2060	3490	5480	7480
F_{zul} [N] ² , ALPHA V/short joining	320	460	640	780/390 ³	1030/515 ³	1745/875 ³	2740	3740
Minimum belt length/short joining [mm]	700	700	700	700/400 ³	700/400 ³	700/400 ³	900	900
Weight per metre [kg/m]	0.033	0.053	0.066	0.083	0.106	0.165	0.248	0.330

¹ Smaller and intermediate widths possible ² Allowable tensile force $F_{zul} = 25\% / 12.5\%$ (ALPHA LINEAR / V) of cord breaking strength F_{Br} $c_{spez} = F_{zul} / \epsilon_{zul}$ [N]
³ Short joining from 400 mm, allowable tensile Force $F_{zul} = 50\%$ of a standard joining

Timing belt pulleys, idlers, clamping plates



Minimum no. of teeth of the pulleys:	$z_{min} = 15$
Minimum pitch diameter of the pulleys:	$d_{w\ min} = 23.87$ mm
Minimum no. of teeth in mesh, clamp. plate:	$z_{CP\ min} = 6$
Minimum-Ø of a plane inside idler:	$d_{min} = 25$ mm
Minimum-Ø of a plane outside idler:	$d_{min} = 60$ mm

We would be pleased to offer advice about technical characteristics and drive design as well as special requirements. Further information can be found in OPTIBELT documentation. © OPTIBELT GmbH 03/2014. Subject to technical modification and change, errors and omissions excepted.

6 COATINGS, CLEATS AND ADJUSTMENTS



6.1 POLYAMIDE FABRIC COATING

All product groups of endless or endlessly connected belts can be used for transport purposes. Application examples are: Parallel or synchronous conveyor, inclined conveyor, accumulating conveyor, vacuum conveyor, withdrawal facility, separator or component positioner.

If required the base belts can be finished with specific coatings/cleats adjustment for each transport task. The price index A for inexpensive to E for high price single coatings refers to the smallest to largest standard width of the coating.

The base belt, the coating and the cleat can be adjusted regarding dimensions and geometry, also in combination with mechanical processing. These subsequently machined special belts receive the designation "Special" in addition to their product group name. For example, the product group name of an endless welded optibelt ALPHA V polyurethane timing belt with subsequently applied coating changes to optibelt ALPHA V SPECIAL.

Flat coatings convey the goods in a frictionally engaged or force-fit manner. Cleats have a form-fit effect. As an alternative to cleats, either strongly structured coatings or subsequently provided contours in flat coatings can ensure a form-fit transport. Despite many experiences and standards, the user is responsible for checking each individual conveyor drive for suitability.

6.1 Polyamide Fabric Coating

Polyamide fabric on the tooth system (PAZ)

Transport lengths over medium to large distances and/or high transport masses require additional support rails to support and guide the belt. Here, the suitable material combination should be observed. E.g. belts with polyamide fabric can be used on the tooth system (PAZ) to reduce the coefficient of friction between timing belt and support rail. Polyamide fabric has an increased wear-resistance effect when the belt runs on support rails. Polyamide fabric on the tooth system can be a part of the base belt and can only be attached in the production processes of optibelt ALPHA LINEAR and ALPHA FLEX. Timing belts cannot be provided subsequently with a polyamide fabric on the tooth system, but on smooth surfaces on the tooth side e.g. in subsequently provided longitudinal grooves.

Polyamide fabric on the top surface (PAR)

The frequently used polyamide fabric is used on the top surface (PAR) to reduce the friction value between belt and transport goods, especially in accumulating conveyors and in the case of a strong relative movement of medium to heavy masses.

Figure 6.1.1 shows an accumulating conveyor with PAR and PAZ, where single boxes are taken over in the front area and transported to the rear area, where the boxes are accumulated. The friction heat between accumulated transport goods and the continuously moving belt is reduced by the PA fabric on the top surface. The PA fabric on the tooth system reduces the friction between support rail and conveyor belt underneath the transport pieces. The wear of the belt is then additionally reduced by the high abrasion resistance.

Polyamide fabric is non-staining with relative movement and exhibits a fair cut resistance.

During production of the polyurethane timing belt optibelt ALPHA LINEAR, a polyamide fabric can be applied on the top surface. This procedure is more cost-efficient than a subsequent coating on the top surface. In the case of the timing belts optibelt ALPHA TORQUE / POWER and ALPHA FLEX, polyamide fabric can only be applied subsequently.

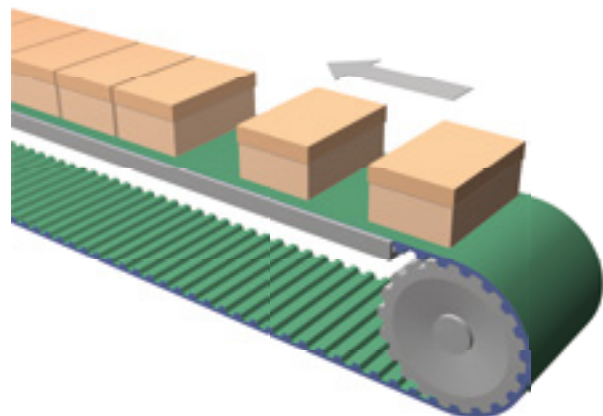
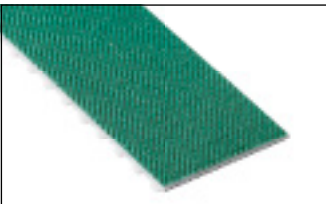

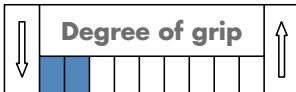
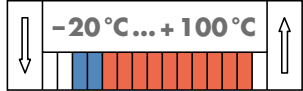
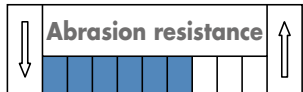

Figure 6.1.1: Accumulating conveyor with PAZ / PAR and support rail

6 COATINGS, CLEATS AND ADJUSTMENTS



6.1 POLYAMIDE FABRIC COATING

Picture of the coating	Designation, colour, material Standard thickness s [mm] Minimum pulley Ø [mm]	Hardness or density	Temperature resistance												
		Degree of grip	Abrasion resistance												
	PA fabric, green, polyamide <table border="1"> <tr> <td>s</td> <td>-*</td> <td>0.5**</td> <td></td> <td></td> <td></td> </tr> <tr> <td>Ø</td> <td>-*</td> <td>25**</td> <td></td> <td></td> <td></td> </tr> </table>	s	-*	0.5**				Ø	-*	25**				 	 
		s	-*	0.5**											
Ø	-*	25**													

- * PAR and/or PAZ is directly applied during the production of the base belts; the PA fabric is therefore included in the belt contour and does not build up on the tooth side or the top surface; the minimum pulley diameters indicated for each profile are applicable. No EU food compliance / FDA for standard PAZ/PAR
 PAZ: on the tooth side on transport belts with support rail and take-off conveyors with pressure bar; polyethylene support rails are only recommended for low and medium loads; for higher loads, steel is recommended.
 PAR: on the top surface for accumulating conveyors; in the case of a relative movement: suitable for smooth transport goods surfaces; less suitable for structured or profiled transport goods surfaces.
- ** PAR subsequently: if required, subsequent application possible
 The oil, fat and general chemicals resistance corresponds approximately to that of the thermoplastic base material; see Table 6.1.1 for guide values for the coefficients of friction; price index: *A, ** D

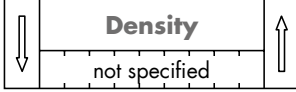
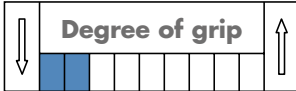
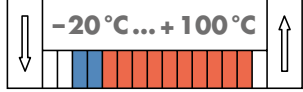
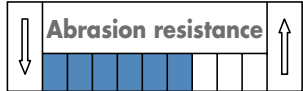
	PA fabric, antistatic, anthracite <table border="1"> <tr> <td>s</td> <td>-*</td> <td>0.5**</td> <td></td> <td></td> <td></td> </tr> <tr> <td>Ø</td> <td>-*</td> <td>25**</td> <td></td> <td></td> <td></td> </tr> </table>	s	-*	0.5**				Ø	-*	25**				 	 
		s	-*	0.5**											
Ø	-*	25**													

*/** see PA fabric, green; for *: Timing belts only in PAZ / PAR design with antistatic characteristics according to Standard 9563; standard for the T5 profile with an overall thickness of 2.55 mm; no EU food compliance / FDA; price index: C

Table 6.1.1 indicates guide values for the coefficients of friction. Depending on the portion of the static or sliding friction of the load, the corresponding coefficient of friction should be considered. The coefficients of friction apply to the new belts, dry operating conditions and can deviate depending on the belt speed and the connected heat development, the heat dissipation and the surface properties of the friction material. The indicated upper and lower limits of the sliding coefficient of friction are related to the belt speeds of 0.1 to 1.0 m/s.

Depending on the contamination, level of wear or special ambient influences, considerable deviations from the guide values have to be expected.

Table 6.1.1: Guide values for friction coefficients

Friction materials	Guide values for friction coefficients			
	Polyurethane		Polyamide fabric	
	Static friction μ_0	Sliding friction μ	Static friction μ_0	Sliding friction μ
Steel	0.7	0.4 ... 0.7	0.5	0.2 ... 0.5
Aluminium	0.6	0.4 ... 0.6	0.4	0.2 ... 0.4
Polyethylene	0.5	0.3 ... 0.5	0.3	0.2 ... 0.3
Glass, smooth	1.0	0.7*... 1,0*	0.5	0.3 ... 0.5
Wood, in fibre direction	0.6	0.4 ... 0.6	0.4	0.2 ... 0.4

* Polyamide fabric is recommended for mainly sliding applications.

6 COATINGS, CLEATS AND ADJUSTMENTS

6.2 SUBSEQUENTLY APPLIED COATINGS



6.2 Subsequently Applied Coatings

In this subchapter, the following topics are addressed, among others:

- Coating material polyurethane (PU)
- Coating material rubber
- Coating material polyvinyl chloride (PVC)
- Coatings for special requirements

The coatings T2, PU rough longitudinal groove, PU-Smart and APL plus, which are applied by extrusion in a second production step, are tested as PA fabric and are a part of the base belt, represent special coatings. These and the variation "reinforced top surface" of the product groups optibelt ALPHA LINEAR / V without the additional designation "Special" are likewise described in this subchapter. The optibelt ALPHA SRP which is cast in one piece with the coating is addressed in Subchapter 6.3.

Coatings on the top surface provide special features for the polyurethane timing belts and other drive belts of the Optibelt assortment, such as V-belts, ribbed belts or chloroprene timing belts, and open up a broad application range in the conveying technology for them. A major task of top surface coatings is the increase or reduction of the friction between top surface of the belt and transport goods. An additional task of the coating may be to protect the belt top surface against wear and damage to ensure the conveying function in the long term.

In addition, further coating features can be utilised:

- Special chemical resistance, e. g. for application in the food industry
- High abrasion resistance, e.g. for accumulating conveyors
- High temperature resistance, e.g. for the transport of heat-treated parts
- Good cutting resistance, e.g. for transport goods with sharp edges
- Non-sticky, e.g. for contact with adhesives
- Antistatic, e.g. for the transport of electronic components
- Absorption of shocks, e.g. for the placing of sensitive goods

The described features are partly based on long-standing experience in application technology. The information listed below may change significantly due to a variety of influences and represents only recommendations that require a suitability check by the user.

Characteristics and design aids

Degree of grip and friction

The coefficient of friction changes due to temperature influences. In the case of rising temperatures, the value increases, and with low temperatures, it is reduced. If smooth, flat and clean surfaces touch each other, adhesion or adherence may be caused. The usual coefficients of friction are then clearly exceeded. With an increasing ageing of the coating, it can be expected that it will decrease. The same applies to contamination and/or wear.

Resistances

Chemical resistances and physical properties depend on the raw materials of the coating, see tables below. Depending on the application, the base belt must be included in these considerations. For example, for application in the food industry, not the whole coated optibelt ALPHA V SPECIAL timing belt is EU food compliant / FDA compliant, even if the polyurethane is EU food compliant / FDA compliant as a raw material for the belt and/or the coating. The EU food compliance / FDA compliance of the coating base material is indicated separately. For the assessment of the ambient temperature, the temperature resistance of the base belt, of the adhesive possibly used and of the coating, care must be taken.

For hot transport goods above 80 °C – this corresponds with the temperature resistance of polyurethane – the duration of the contact depending on the transport mass and the coating thickness should be considered. Also cooling phases are to be included in the considerations. If an adhesive is used to attach the coating, the heat which is transferred or penetrates from the transport goods through the coating to the adhesive should not be higher than approx. 90 °C for any length of time.

6 COATINGS, CLEATS AND ADJUSTMENTS

6.2 SUBSEQUENTLY APPLIED COATINGS



Minimum pulley diameter

The minimum pulley diameter of internal pulleys for the coating materials and thicknesses – not of the chosen base belt – can be seen in the tables below which contain descriptions of the coatings. These should not be lower than the recommended values, to avoid the detachment of, and cracks in the coating and opening joints. Increasing the pulley diameter considerably reduces the load on the coating in the turn.

If deviated coating thicknesses are required for the standard thicknesses listed in the tables, the following formulas can be used for a rough determination of the minimum pulley diameters $d_{s \text{ min}}$ as a guide value.

$$d_{s \text{ min}} \geq 20 \cdot s \quad [\text{mm}] \quad \text{with } s \text{ [mm]}$$

$$d_{s \text{ min}} \geq d_w (z_{\text{min}}) \quad [\text{mm}] \quad \text{with } d_w \text{ [mm]}$$

For the determination of the drive geometry, the minimum number of teeth of the pulley z_{min} and the corresponding effective diameter d_w depending on the profile and technical design of the relevant base belt must be included. They are defined in the Technical Data Sheets of the base belts.

If top surface guide or tension idlers are to be used, hard coating larger than/equal to 85 Shore A should be used. The selected minimum pulley diameter of the external idler should be at least 50 % higher than the guide value for the minimum pulley diameter $d_{s \text{ min}}$. In this case, the minimum pulley diameter d_{min} of the base belt must be also observed. Softer materials, foams, structured and profiled coatings are not really suitable for an operation with backside idlers, as these might be overloaded and may cause an uncontrolled belt tension decrease in the transport belt.

Coating thickness, tolerances

The selection of the coating thickness may depend on the following requirements:

- Special ambient conditions such as dust may lead to the requirement of profiled or structured coatings which are defined in thickness
- Wear resistance to abrasion, e.g. due to relative movement
- Shock absorption when placing the transport goods on the belt
- Height compensation for transport goods transfer
- Tolerance compensation of transport goods height
- Groove and recess height
- Projection of flanges and the support rail guide flanks
- Pulley diameter
- Material costs of the coating

For the assessment of the potential projection of the coating over the flange, the outside diameter of the timing belt pulley, the belt web height and the selected coating thickness should be considered. For the assessment of the potential projection of the coating over the support rail flank, the overall height of the conveyor belt, consisting of belt height and coating thickness should be considered.

The conveyor belt tolerances can vary considerably due to the thickness and flatness tolerances of the different coatings. The tolerances of the overall height and the flatness can be reduced by subsequent grinding of the conveyor belt. By indicating the overall belt height tolerance, the subordinated single tolerances of the base belt height and coating thickness are covered. Details see Subchapter 6.6.

6 COATINGS, CLEATS AND ADJUSTMENTS

6.2 SUBSEQUENTLY APPLIED COATINGS



Pre-selection for coatings of polyurethane (PU), rubber and polyvinyl chloride (PVC)

Table 6.2.1: Pre-selection of the coating features depending on transport goods and conditions











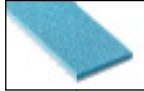

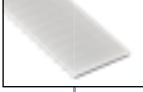
Transport goods features			
recommended	possible	not recommended	
Low, medium, high weight	Low, medium, high weight	Low, medium, high weight	Low, medium, high weight
Smooth, structured, profiled area	Smooth, structured, profiled area	Smooth, structured, profiled area	Smooth, structured, profiled area
Dry, wet, dusty	Dry, wet, dusty	Dry, wet, dusty	Dry, wet, dusty
Impact sensitive, resistant	Impact sensitive, resistant	Impact sensitive, resistant	Impact sensitive, resistant
Transport goods			
↑ ↓ ↑ ↓ ↑ ↓ ↑ ↓			
Coating			
Foam	Profiled or structured	Smooth or slightly structured	
Porol, cell rubber Sylomer, polyurethane	Supergrip, PVC Minigrip, PVC	Linatex, rubber PVC petrol blue	PU foil Polythan, PU
Soft, fine-pored surface	Medium hardness, profiled or structured	Medium hardness, slightly structured or smooth	High hardness, smooth surface
 $\approx 300 \text{ kg/m}^3$	 $\approx 50 \text{ Shore A}$	 $\approx 50 \text{ Shore A}$	 $\approx 80 \text{ Shore A}$
With relative movement high abrasion	With relative movement high abrasion	With relative movement medium abrasion	With relative movement low abrasion
Coating			

6 COATINGS, CLEATS AND ADJUSTMENTS

6.2 SUBSEQUENTLY APPLIED COATINGS



Table 6.2.2: Material and surface properties of coatings

Foam	Profiled or structured	Smooth or slightly structured	Foam Profiled Smooth
Polyurethane (PU)			  
<ul style="list-style-type: none"> - Sylomer R (see Fig.) - Sylomer L - Celloflex - Sylomer M - PU-Smart - PU 06 	<ul style="list-style-type: none"> - PU longitudinal groove (see Fig.) - Pointed cone, FDA - PU longitudinal groove fine - PU Spike profile, FDA 	<ul style="list-style-type: none"> - PU foil 65 Shore A - Polythan D15 - Polythan D44 - PU foil blue, FDA - PU foil 85 Shore A - T2 (see Fig.) - PU foil 92 Shore A - Reinforced top surface 	
Rubber			  
<ul style="list-style-type: none"> - EPDM - Porol (see Fig.) 	<ul style="list-style-type: none"> - Supergrip black (see Fig.) - Supergrip blue 	<ul style="list-style-type: none"> - RP 400 (see Fig.) - Linatex - Linaplus FGL, FDA - Correx beige - NG red - Linatrilite - Elastomer green 	
Polyvinyl chloride (PVC)			  
<ul style="list-style-type: none"> - PVC shark tooth (see Fig.) - PVC longitudinal groove - Supergrip petrol blue - Supergrip green - PVC cleats, FDA - Minigrip petrol blue - Minigrip green - Pebbles rounded cone, FDA - Supergrip white, FDA (see Fig.) - PVC fishbone pattern, FDA - PVC saw tooth, FDA - PVC triangular profile, FDA 		<ul style="list-style-type: none"> - PVC foil green - PVC foil blue, FDA - PVC foil white, FDA - APL plus - PVC foil petrol blue (see Fig.) 	
Special/PA fabric			  
<ul style="list-style-type: none"> - PTFE (see Fig.) - TT60 - Para fleece - Chrome leather (see Fig.) - Viton - PA fabric (see Fig.) - PA fabric antistatic 			

6 COATINGS, CLEATS AND ADJUSTMENTS



6.2 SUBSEQUENTLY APPLIED COATINGS

COATING MATERIAL POLYURETHANE (PU)

Coating material polyurethane (PU)

Smooth polyurethane coatings are mainly used as wear protection, since they exhibit the highest cutting resistance and abrasion strength compared to other coating materials. The coefficient of friction does not change or changes only slightly in relation to a polyurethane base belt.

Polyurethane foils can be welded on optibelt ALPHA LINEAR / V and ALPHA FLEX in addition to adhesion as a subsequent production process. Polyurethane foils can also be applied on optibelt ALPHA LINEAR timing belts by extrusion.

The profiled polyurethane foil PU longitudinal groove prevents the adherence of smooth transport goods, e.g. flat glass, particularly in the case of moisture through linear support.



Polyurethane foams with a low density are primarily used for shock absorption when placing sensitive parts.

Foamed polyurethane coatings with a high density are highly suitable for mechanical processing, e.g. recesses to hold the transport goods. Due to the open-pored structure soft polyurethane foams exhibit a low abrasion strength.

Table 6.2.3: Polyurethane coatings, known characteristics and applications

PU	Physical and chemical properties	Rubber	PVC
+/-*	Polyurethane elastomer has a medium degree of grip; *high grip through adhesion on smooth, clean friction partners	++	+
++	PU foams for light, impact sensitive parts; profiled and smooth PU surfaces for low to heavy transport weights	+	+
+/-	The temperature resistance does not include low or high temperatures and corresponds with the polyurethane timing belts	++	+
++	Polyurethane elastomer does not stain during the relative movements; smooth PU exhibits a high abrasion strength and very good cutting resistance	+/-	+
++	The oil, fat and general chemicals resistance is the highest compared with other coatings; partly EU food compliance / FDA	+/-	++
Application areas	Wear and cutting protection with smooth polyurethane coating; transport or discharge conveyors in all areas of conveying technology; partly with EU food compliance / FDA		

++ excellent to very good, + good, +/- satisfactory to sufficient, - deficient to insufficient

Foam	Profiled or structured	Smooth or slightly structured
e. g. PU-Smart	e. g. PU longitudinal groove	e. g. T2
		

6 COATINGS, CLEATS AND ADJUSTMENTS



6.2 SUBSEQUENTLY APPLIED COATINGS

COATING MATERIAL POLYURETHANE (PU)

Picture of the coating	Designation, colour, material Standard thickness s [mm] Minimum pulley Ø [mm]	Hardness or density	Temperature resistance
		Degree of grip	Abrasion resistance
Foam			



Sylomer R, blue, PU foam

s	6.0	12.0			
Ø	120	240			

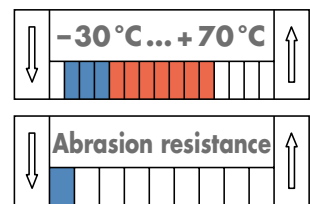
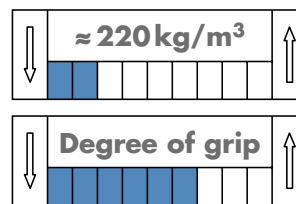

Hardness: ≈ 10 Shore A; high dynamic load capacity; conveyance of lightweight, fragile parts; discharge conveyors with low loads; e.g. in the paper and textile industry; for top pressure belts; price index: C, D



Sylomer L, green, PU foam

s	6.0	12.0	15.0	20.0	25.0
Ø	120	240	300	400	500

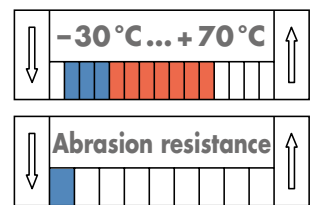
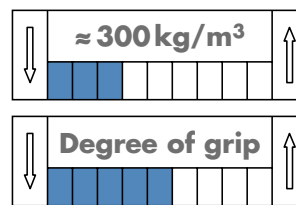

Hardness: ≈ 15 Shore A; widely-used; same application as Sylomer R, blue, but increased hardness; price index: D



Celloflex, beige, microcell PU

s	2.0	3.0	4.0	5.0	6.0	8.0
Ø	40	60	70	90	110	140

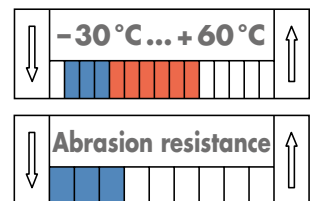
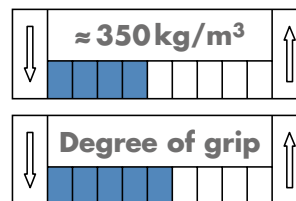

Widely-used; also known as foam with medium hardness, for extremely high dynamic load capacity and good abrasion resistance; e.g. for foils, textiles and packaging; price index: B - D



Sylomer M, brown, PU foam

s	6.0	12.0			
Ø	120	240			

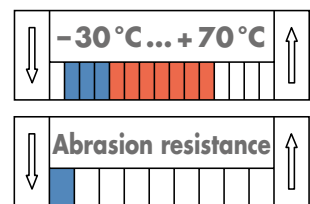
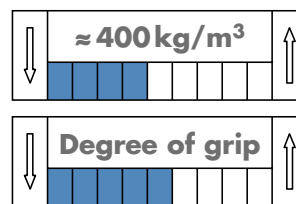

Hardness: ≈ 22 Shore A; same application as Sylomer R, blue, but greater hardness as Sylomer L, green; price index: D, E



PU-Smart, fine-pored PU

s	2.0	3.0	6.0	8.0	10.0	12.0
Ø	60	70	120	160	200	240

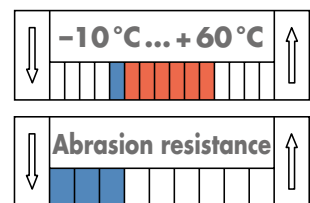
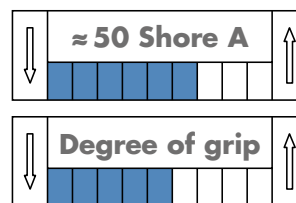

Same application areas as PU O6, but lower-priced; a little less abrasion-resistant than PU O6; unlike PU O6 this coating can be extruded as a standard coating directly onto the optibelt ALPHA LINEAR AT10 in 3 mm thickness; further profiles on request; ALPHA V together with the coating and hence without joint, even with greater lengths; e.g. for use in paper and glass industry; good mechanical processing capabilities, e.g. cutting of pockets for vacuum transport; price index: C - E





6 COATINGS, CLEATS AND ADJUSTMENTS



6.2 SUBSEQUENTLY APPLIED COATINGS



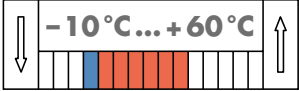

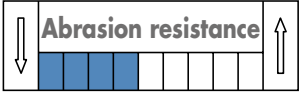
COATING MATERIAL POLYURETHANE (PU)

Picture of the coating	Designation, colour, material Standard thickness s [mm] Minimum pulley Ø [mm]	Hardness or density	Temperature resistance
		Degree of grip	Abrasion resistance
Foam			



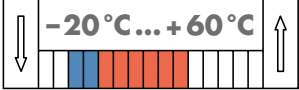

	PU 06, yellow, fine-pored PU <table border="1"> <tr> <td>s</td> <td>2.0</td> <td>3.0</td> <td>5.0</td> <td>6.0</td> <td>8.0</td> <td>10.0</td> </tr> <tr> <td>Ø</td> <td>60</td> <td>70</td> <td>100</td> <td>120</td> <td>160</td> <td>200</td> </tr> </table>	s	2.0	3.0	5.0	6.0	8.0	10.0	Ø	60	70	100	120	160	200		
		s	2.0	3.0	5.0	6.0	8.0	10.0									
Ø	60	70	100	120	160	200											
																	

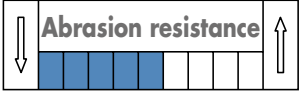
Widely-used; foam with high abrasion resistance; e.g. in paper and glass industry; easy mechanical processing, e.g. cutting of pockets for vacuum transport; alternatively without joint in a spraying process for short and medium length ranges; price index: D, E



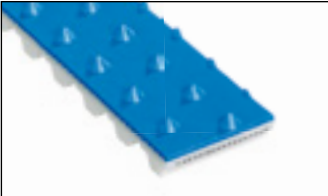

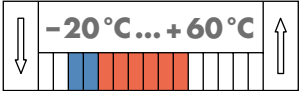
Profiled or structured

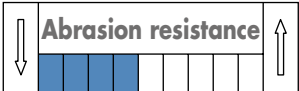
	PU longitudinal groove, transparent, PU <table border="1"> <tr> <td>s</td> <td>2.0</td> <td></td> <td></td> <td></td> <td></td> </tr> <tr> <td>Ø</td> <td>60</td> <td></td> <td></td> <td></td> <td></td> </tr> </table>	s	2.0					Ø	60						
		s	2.0												
Ø	60														
															

V-shaped ribs with slightly rounded end; pitch approx. 2.3 mm; reduced adherence of smooth and dry transport goods, e.g. flat glass; draining of liquids possible; price index: C

	Pointed cone, blue, polyurethane (FDA) <table border="1"> <tr> <td>s</td> <td>2.5</td> <td></td> <td></td> <td></td> <td></td> </tr> <tr> <td>Ø</td> <td>30</td> <td></td> <td></td> <td></td> <td></td> </tr> </table>	s	2.5					Ø	30						
		s	2.5												
Ø	30														
															

EU food compliance / FDA; e.g. conveyance of frozen food; for narrow belts only single-row profiles with pointed cones; line distance between the cones approx. 8.5 mm; cone height approx. 2.0 mm; cone Ø approx. 3.5 mm; design variation in white colour; price index: E

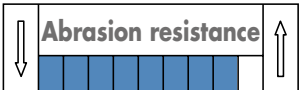
	PU longitudinal groove fine, transparent, PU <table border="1"> <tr> <td>s</td> <td>3.5</td> <td></td> <td></td> <td></td> <td></td> </tr> <tr> <td>Ø</td> <td>70</td> <td></td> <td></td> <td></td> <td></td> </tr> </table>	s	3.5					Ø	70						
		s	3.5												
Ø	70														
															

V-shaped ribs with trapezoidal end; pitch approx. 2 mm; reduced adherence of smooth and dry transport goods, e.g. flat glass; draining of liquids possible; in contrast to PU longitudinal groove 65 Shore A, this coating is directly extruded on the optibelt ALPHA LINEAR as standard supply; welding on ALPHA V together with the coating without joint; continuously adhesive; profiles and further hardnesses on request; price index: A

6 COATINGS, CLEATS AND ADJUSTMENTS



6.2 SUBSEQUENTLY APPLIED COATINGS

COATING MATERIAL POLYURETHANE (PU)

Picture of the coating	Designation, colour, material Standard thickness s [mm] Minimum pulley Ø [mm]	Hardness or density	Temperature resistance
		Degree of grip	Abrasion resistance
Profiled or structured			



PU spike profile, beige, PU (FDA)

s	5.3				
Ø	60				

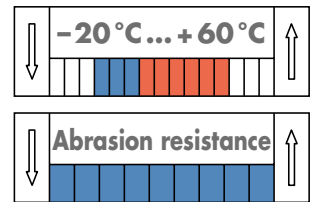
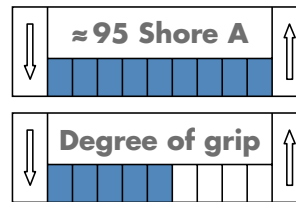

EU food compliance / FDA; e.g. for the conveyance of frozen food; for narrow belts only single-row profiles with pointed profiles; row distance approx. 8.5 mm; pointed, rounded cone; cone height approx. 4.0 mm; cone Ø approx. 3.3 mm; total height 5.3 mm; price index: E

Smooth or slightly structured			
--------------------------------------	--	--	--



PU foil 65 Shore A, transparent, PU

s	2.0	3.0	4.0		
Ø	60	80	100		

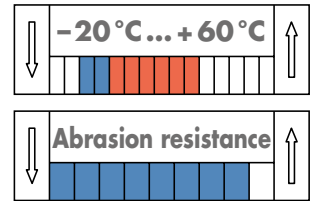
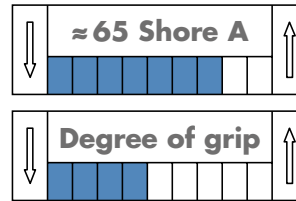

Strongly adhesive for smooth, dry surfaces; e.g. for the conveyance of glass; due to possible indentation less suitable for the conveyance of light goods such as foils, see also PU foil 85 Shore A; price index: D



Polythan D15, transparent/yellowish, PU

s	2.0	3.0	5.0		
Ø	60	80	120		

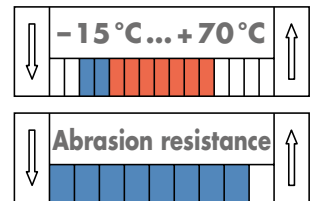
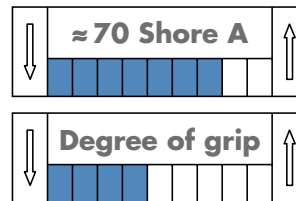

Also known as "Festvulkollan"; despite low hardness and high dynamic load capacity it has high abrasion resistance and high tear resistance; e.g. for applications such as discharge belts; price index: C - E



Polythan D44, transparent/brownish, PU

s	2.0	3.0	5.0		
Ø	60	80	120		

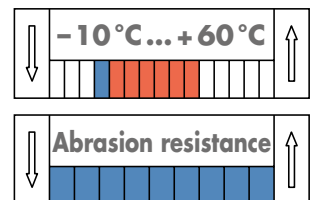
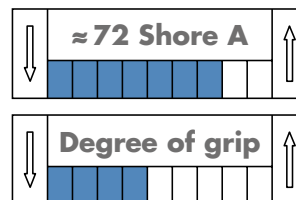

Characteristics similar to Polythan D15, however, lower tear resistance; price index: A - D

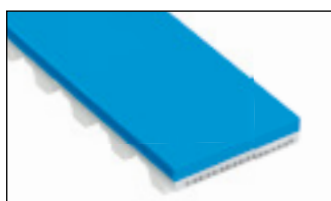

PU foil blue, polyurethane (FDA)

s	2.0	3.0			
Ø	60	80			

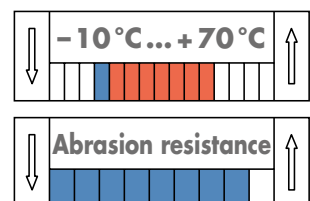
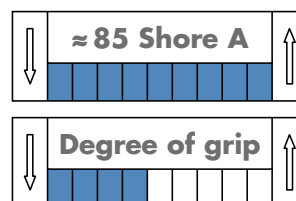

PU basic material EU food compliant / FDA; also for use in the pharmaceutical industry; compared with other smooth FDA materials strong hardness and abrasion resistance; price index: C, D

6 COATINGS, CLEATS AND ADJUSTMENTS



6.2 SUBSEQUENTLY APPLIED COATINGS

COATING MATERIAL POLYURETHANE (PU)

Picture of the coating	Designation, colour, material Standard thickness s [mm] Minimum pulley Ø [mm]	Hardness or density	Temperature resistance
		Degree of grip	Abrasion resistance
Smooth or slightly structured			

	PU foil 85 Shore A, transparent, PU														
	<table border="1"> <tr> <td>s</td> <td>2.0</td> <td>3.0</td> <td>4.0</td> <td></td> <td></td> </tr> <tr> <td>Ø</td> <td>60</td> <td>80</td> <td>100</td> <td></td> <td></td> </tr> </table>	s	2.0	3.0	4.0			Ø	60	80	100				
	s	2.0	3.0	4.0											
Ø	60	80	100												

Widely-used; particularly suitable for heavy, sharp-edged conveyed goods, e.g. in sheet metal and glass processing; a bit less adhesive than PU foil 65 Shore A; also see T2; price index: C, D

	T2, transparent, PU										
	<table border="1"> <tr> <td>s</td> <td>2.0 (T/AT10, H)</td> <td></td> <td></td> </tr> <tr> <td>Ø</td> <td>60</td> <td></td> <td></td> </tr> </table>	s	2.0 (T/AT10, H)			Ø	60				
	s	2.0 (T/AT10, H)									
Ø	60										

T2: 2 mm height, 85 Shore A; in contrast to PU foil 85 Shore A, this coating can be extruded directly onto the optibelt ALPHA LINEAR T10, AT10 or H; joined to ALPHA V with coating by welding process possible; further profiles, heights and hardness ranges on request; price index: A

	PU foil 92 Shore A, white, polyurethane														
	<table border="1"> <tr> <td>s</td> <td>2.0</td> <td>3.0</td> <td>4.0¹</td> <td></td> <td></td> </tr> <tr> <td>Ø</td> <td>80</td> <td>100</td> <td>120</td> <td></td> <td></td> </tr> </table>	s	2.0	3.0	4.0 ¹			Ø	80	100	120				
	s	2.0	3.0	4.0 ¹											
Ø	80	100	120												

Compound identical to optibelt ALPHA LINEAR / V; same application as PU foil 85 Shore A, however reduced degree of grip and improved abrasion resistance; price index: C, D

	Reinforced top surface, white, polyurethane										
	<table border="1"> <tr> <td>s</td> <td>1.3 (T/AT5)</td> <td>2.5 (T/AT10)</td> <td></td> </tr> <tr> <td>Ø</td> <td>35</td> <td>80</td> <td></td> </tr> </table>	s	1.3 (T/AT5)	2.5 (T/AT10)		Ø	35	80			
	s	1.3 (T/AT5)	2.5 (T/AT10)								
Ø	35	80									

Compound identical to optibelt ALPHA LINEAR / V; same application as PU foil 85 Shore A, however reduced degree of grip and improved abrasion resistance; in contrast to the PU foil 92 Shore A the reinforced top surface is part of the base belt for the profiles T5 / AT5, s = 1.3 mm, T10 / AT10, s = 2.5 mm; welding to ALPHA V without joint, continuously adhesive; further profiles, heights and hardnesses as well as optibelt ALPHA FLEX on request; price index: A

¹ Coatings of this thickness: no standard stock keeping
Further coating thicknesses and polyurethane designs on request; preselection see Table 6.2.1; characteristics and applications see Table 6.2.3; assumptions: "degree of grip" with slightly structured transport goods, "abrasion resistance" with relative movement; price index: A (low price) to E (high price), related to the smallest and largest standard thickness

6 COATINGS, CLEATS AND ADJUSTMENTS



6.2 SUBSEQUENTLY APPLIED COATINGS COATING MATERIAL RUBBER

Coating material rubber

Rubber coatings achieve, in comparison to other coatings of the same density or hardness, the highest coefficients of friction under dry conditions and also under wet conditions. This is usually accompanied with a lower abrasion strength.



Depending on the material composition of the rubber, lower or higher temperatures can be covered in contrast to other coating materials. The fluorinated rubber Viton resistant to high temperatures is listed in the following subchapter under "Coatings for special requirements". The material composition also significantly determines the resistance to oils, greases and other chemicals which does, however, not reach the resistances of polyurethane and polyvinyl chloride.

The rubber coating Supergrip black improves, due to its profiling, the already good degree of grip even more for light transport goods. This applies also to rubber foams which are particularly used in light, sensitive transport goods.

Table 6.2.4: Rubber coatings, characteristics and applications

Rubber	Physical and chemical properties	PU	PVC
++	Rubber exhibits the comparatively highest coefficient of friction and the best degree of grip under dry and wet conditions.	+/-	+
+	Foams for light, impact sensitive parts; profiled and smooth rubber surfaces for low to medium transport weights	++	+
++	In contrast to many other coating materials, low or high temperatures can be covered.	+/-	+
+/-	In the case of relative movements rubber can slightly mark; it exhibits a medium abrasion and a high cutting strength.	++	+
+/-	The oil, grease and general chemicals resistance is rather low; improved with NBR; one coating EU food compliant / FDA	++	++
Application areas	For all transport goods, e.g. wood, cardboard, metal, glass, building materials etc., with up to medium requirements for cleanliness and freedom of streaks on the surfaces due to the partly visible abrasion; less applicable for high requirements regarding cleanliness and chemical resistance and hardly applicable in the food industry, exception: Linaplus FGL		

++ excellent to very good, + good, +/- satisfactory to sufficient, - deficient to insufficient

Foam	Profiled or structured	Smooth or slightly structured
e. g. Porol	e. g. Supergrip black	e. g. Linatex
		

6 COATINGS, CLEATS AND ADJUSTMENTS

6.2 SUBSEQUENTLY APPLIED COATINGS

COATING MATERIAL RUBBER



Picture of the coating	Designation, colour, material Standard thickness s [mm] Minimum pulley Ø [mm]	Hardness or density	Temperature resistance
		Degree of grip	Abrasion resistance
Foam			



EPDM, black, synthetic rubber

s	2 ¹	3 ¹	4 ¹	5 ¹	6 ¹
Ø	40	40	50	60	80

≈ 175 kg/m³

Temperature: -20°C... +120°C

Degree of grip: [Bar chart showing 5 bars filled]

Abrasion resistance: [Bar chart showing 5 bars filled]

EPDM: Ethylene-Propylene-Polymerase; foam, e.g. for hot glass or metal products; improved chemicals and ageing resistance; improved abrasion resistance; no improved oil and grease resistance compared to natural rubber; price index: C, D



Porol, black, cell rubber

s	5	12	15		
Ø	60	150	200		

≈ 190 kg/m³

Temperature: -40°C... +70°C

Degree of grip: [Bar chart showing 5 bars filled]

Abrasion resistance: [Bar chart showing 5 bars filled]

Widely-used; closed pored; e.g. for textile and paper industry; for height adjustments in combination with a further thin, elastic protective coating such as Linatex; price index: A - C

Profiled or structured



Supergrip black, rubber

s	3.0				
Ø	60				

≈ 70 Shore A

Temperature: -20°C... +70°C

Degree of grip: [Bar chart showing 5 bars filled]

Abrasion resistance: [Bar chart showing 5 bars filled]

Used for slight height compensation; low shock absorption capabilities and slight relative movement due to profile design possible; improved degree of grip even in case of moisture and dirt; e.g. for the conveying of sharp-edged stones or of flat glass in high vacuum applications, when e.g. PVC might shrink; price index: C

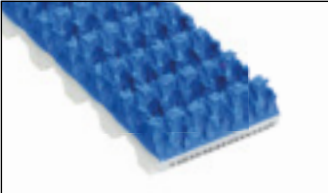

Supergrip blue, nitrile rubber

s	3.0				
Ø	60				

≈ 71 Shore A

Temperature: -18°C... +121°C

Degree of grip: [Bar chart showing 5 bars filled]

Abrasion resistance: [Bar chart showing 5 bars filled]

Characteristics similar to Supergrip black; improved temperature, oil, grease and ageing resistance compared to natural rubber; e.g. for the conveying of packaged food; price index: E

¹ Coatings of this thickness: no standard stock keeping

6 COATINGS, CLEATS AND ADJUSTMENTS

6.2 SUBSEQUENTLY APPLIED COATINGS

COATING MATERIAL RUBBER



Picture of the coating	Designation, colour, material Standard thickness s [mm] Minimum pulley Ø [mm]	Hardness or density	Temperature resistance
		Degree of grip	Abrasion resistance
Smooth or slightly structured			

	RP 400, yellow, natural rubber <table border="1"> <tr> <td>s</td> <td>2.0</td> <td>3.0</td> <td>5.0</td> <td>6.0</td> <td>8.0</td> <td>10.0</td> </tr> <tr> <td>Ø</td> <td>40</td> <td>60</td> <td>100</td> <td>130</td> <td>180</td> <td>220</td> </tr> </table>	s	2.0	3.0	5.0	6.0	8.0	10.0	Ø	40	60	100	130	180	220		
		s	2.0	3.0	5.0	6.0	8.0	10.0									
		Ø	40	60	100	130	180	220									

Fine fabric structure; characteristics similar to Linatex, however higher abrasion resistance; use e.g. in cable pulling systems; price index: B - D

	Linatex, red, natural rubber <table border="1"> <tr> <td>s</td> <td>1.5</td> <td>2.4</td> <td>3.2</td> <td>5.0</td> <td>6.4</td> <td>8.0</td> </tr> <tr> <td>Ø</td> <td>30</td> <td>50</td> <td>65</td> <td>100</td> <td>140</td> <td>180</td> </tr> </table>	s	1.5	2.4	3.2	5.0	6.4	8.0	Ø	30	50	65	100	140	180		
		s	1.5	2.4	3.2	5.0	6.4	8.0									
		Ø	30	50	65	100	140	180									

Very widely-used; universally applicable, further improved degree of grip possible due to optionally ground surface; under moist conditions best coefficient of friction; applications e.g. as discharger belts, for use in a vacuum or for the conveyance of wet flat glass; price index: B - E

	Linaplus FGL, white, natural rubber (FDA) <table border="1"> <tr> <td>s</td> <td>2.0</td> <td>3.0</td> <td>6.0</td> <td></td> <td></td> <td></td> </tr> <tr> <td>Ø</td> <td>50</td> <td>65</td> <td>130</td> <td></td> <td></td> <td></td> </tr> </table>	s	2.0	3.0	6.0				Ø	50	65	130					
		s	2.0	3.0	6.0												
		Ø	50	65	130												

EU food compliance / FDA; conveyance of e.g. wet and/or pressure-sensitive food; price index: C

	Correx beige, natural rubber <table border="1"> <tr> <td>s</td> <td>4.0</td> <td>6.0</td> <td>10.0</td> <td></td> <td></td> <td></td> </tr> <tr> <td>Ø</td> <td>80</td> <td>130</td> <td>220</td> <td></td> <td></td> <td></td> </tr> </table>	s	4.0	6.0	10.0				Ø	80	130	220					
		s	4.0	6.0	10.0												
		Ø	80	130	220												

Universally applicable; characteristics similar to Linatex; layers of adhesives may be visible in the mitred joints area; e.g. for the conveyance of aluminium profiles; price index: C, D

	NG red, natural rubber <table border="1"> <tr> <td>s</td> <td>1.6</td> <td>2.0</td> <td>3.0</td> <td>5.0</td> <td>6.0</td> <td>8.0</td> </tr> <tr> <td>Ø</td> <td>30</td> <td>40</td> <td>60</td> <td>100</td> <td>140</td> <td>180</td> </tr> </table>	s	1.6	2.0	3.0	5.0	6.0	8.0	Ø	30	40	60	100	140	180		
		s	1.6	2.0	3.0	5.0	6.0	8.0									
		Ø	30	40	60	100	140	180									

NG = natural rubber; fine fabric structure; low-priced wear protection with low degree of grip under moist and wet conditions and again poorer processing capability compared to Linatex; price index: A - D

¹ Coatings of this thickness: no standard stock keeping

6 COATINGS, CLEATS AND ADJUSTMENTS

6.2 SUBSEQUENTLY APPLIED COATINGS

COATING MATERIAL RUBBER



Picture of the coating	Designation, colour, material Standard thickness s [mm] Minimum pulley Ø [mm]	Hardness or density	Temperature resistance
		Degree of grip	Abrasion resistance
Smooth or slightly structured			

	Linatril, orange, polymer NBR <table border="1"> <tr> <td>s</td> <td>3.0</td> <td>6.0</td> <td>10.0</td> <td></td> <td></td> </tr> <tr> <td>Ø</td> <td>65</td> <td>140</td> <td>220</td> <td></td> <td></td> </tr> </table>	s	3.0	6.0	10.0			Ø	65	140	220				
		s	3.0	6.0	10.0										
		Ø	65	140	220										

NBR: Nitrile Butadiene Rubber; improved temperature, oil, grease and ageing resistance compared to natural rubber; comparably good mechanical processing capability; e. g. vacuum transport of oil-covered sheets; price index: D

	Elastomer green, rubber <table border="1"> <tr> <td>s</td> <td>2.0</td> <td></td> <td></td> <td></td> <td></td> </tr> <tr> <td>Ø</td> <td>60</td> <td></td> <td></td> <td></td> <td></td> </tr> </table>	s	2.0					Ø	60						
		s	2.0												
		Ø	60												

Fine fabric structure; high cut resistance; for the conveyance of e.g. uncoated wood, sharp-edged cardboard packaging or light, sharp-edged stones; price index: E

¹ Coatings of this thickness: no standard stock keeping
 Further coating thicknesses and rubber designs on request; preselection see Table 6.2.1; characteristics and applications see Table 6.2.4;
 assumptions: "degree of grip" with slightly structured transport goods, "abrasion resistance" with relative movement;
 price index: A (low price) to E (high price), related to the smallest and largest standard thickness

6 COATINGS, CLEATS AND ADJUSTMENTS



6.2 SUBSEQUENTLY APPLIED COATINGS

POLYVINYL CHLORIDE (PVC) COATING MATERIAL



Coating material polyvinyl chloride (PVC)

Polyvinyl chloride foils exhibit a good to very good chemical resistance and a high coefficient of friction which, however does not achieve the values of rubber coatings. PVC foils with smooth surfaces have an adhesive effect and are preferred for the foil transport. Since the abrasion resistance is good as well, PVC coatings can be applied in many areas. EU food compliant / FDA versions allow the application in the food industry. The profiled PVC coatings exhibit better degrees of grip than smooth foils. Also the EU food compliant / FDA versions are therefore offered in different profiles.

Table 6.2.5: Polyvinyl chloride coatings, characteristics and applications

PVC	Physical and chemical properties	Rubber	PU
+	Polyvinyl chloride thermoplastic exhibits a comparatively medium to high degree of grip.	++	+/-
+	Profiled to smooth PVC for low to medium transport weights; no PVC foams	+	++
+	The temperature resistance does not cover low temperatures, but high temperatures.	++	+/-
+	Non marking in the case of relative movements; high abrasion and medium cutting strength.	+/-	++
++	The oil, grease and general chemicals resistance is high; comparatively biggest portion of EU food compliant / FDA coatings	+/-	++
Application areas	For high requirements regarding chemical resistance or cleanliness for e.g. foils, textiles, paper; partly EU food compliance / FDA; profiled designs especially under wet and moist conditions; not or less applicable for impact sensitive or heavy, sharp-edged transport goods		

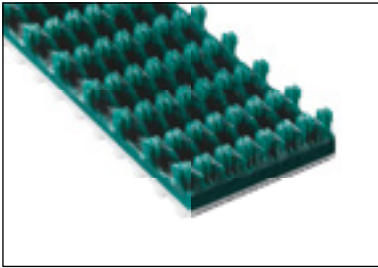
++ excellent to very good, + good, +/- satisfactory to sufficient, - deficient to insufficient

Foam	Profiled or structured	Smooth or slightly structured
—	e. g. Supergrip green	e. g. PVC foil white
—		

6 COATINGS, CLEATS AND ADJUSTMENTS



6.2 SUBSEQUENTLY APPLIED COATINGS

POLYVINYL CHLORIDE (PVC) COATING MATERIAL

Picture of the coating	Designation, colour, material Standard thickness s [mm] Minimum pulley Ø [mm]	Hardness or density	Temperature resistance
		Degree of grip	Abrasion resistance
Profiled or structured			



PVC shark tooth, petrol blue, PVC

	s 6.0								
	Ø 55								

↓	≈ 35 Shore A	↑
↓	Degree of grip	↑

↓	-15 °C... +110 °C	↑
↓	Abrasion resistance	↑

The degree of grip depends on the direction of conveyance: heavily profiled goods conveyed contrary to the direction of the tooth, smooth or slightly structured goods in direction of the tooth due to the close attachment to the transport good; good compensation of height tolerances of the goods conveyed especially at discharge belts, e.g. for the conveyance of bottles; price index: D



PVC longitudinal groove, black, PVC

	s 2.0								
	Ø 30								

↓	≈ 35 Shore A	↑
↓	Degree of grip	↑

↓	-20 °C... +70 °C	↑
↓	Abrasion resistance	↑

V-shaped ribs with flat tops; improved degree of grip under dusty conditions, draining of liquids possible; price index: B

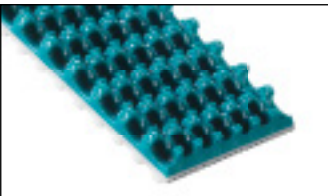

Supergrip petrol blue, polyvinyl chloride

	s 3.0								
	Ø 60								

↓	≈ 40 Shore A	↑
↓	Degree of grip	↑

↓	-10 °C... +90 °C	↑
↓	Abrasion resistance	↑

Common/widely-used; applicable for slight height compensation, low shock absorption capabilities and slight relative motion possible; improved degree of grip even in case of moisture and dirt; e.g. for the timber, glass and packaging industries; price index: A

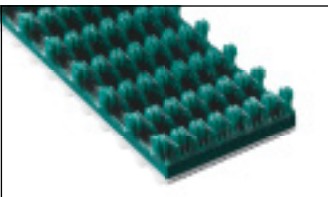

Supergrip green, polyvinyl chloride

	s 3.0								
	Ø 60								

↓	≈ 40 Shore A	↑
↓	Degree of grip	↑

↓	-10 °C... +90 °C	↑
↓	Abrasion resistance	↑

Characteristics and application areas same as Supergrip petrol blue; slightly more flexible due to larger distance between the cleats; price index: C



PVC cleats, white, PVC (FDA)

	s 1.5								
	Ø 60								

↓	≈ 60 Shore A	↑
↓	Degree of grip	↑

↓	-15 °C... +90 °C	↑
↓	Abrasion resistance	↑

EU food compliant / FDA; thin profile for improved degree of grip even under moist conditions; conveyance of packages in the food industry; price index: C

6 COATINGS, CLEATS AND ADJUSTMENTS



6.2 SUBSEQUENTLY APPLIED COATINGS

POLYVINYL CHLORIDE (PVC) COATING MATERIAL

Picture of the coating	Designation, colour, material Standard thickness s [mm] Minimum pulley Ø [mm]	Hardness or density	Temperature resistance
		Degree of grip	Abrasion resistance
Profiled or structured			

	Minigrip petrol blue, polyvinyl chloride <table border="1"> <tr> <td>s</td> <td>1.0</td> <td></td> <td></td> <td></td> <td></td> </tr> <tr> <td>Ø</td> <td>30</td> <td></td> <td></td> <td></td> <td></td> </tr> </table>	s	1.0					Ø	30					<table border="1"> <tr> <td>↓</td> <td>≈ 60 Shore A</td> <td>↑</td> </tr> <tr> <td>↓</td> <td>Degree of grip</td> <td>↑</td> </tr> </table>	↓	≈ 60 Shore A	↑	↓	Degree of grip	↑	<table border="1"> <tr> <td>↓</td> <td>-10°C... +110°C</td> <td>↑</td> </tr> <tr> <td>↓</td> <td>Abrasion resistance</td> <td>↑</td> </tr> </table>	↓	-10°C... +110°C	↑	↓	Abrasion resistance	↑
		s	1.0																								
		Ø	30																								
↓	≈ 60 Shore A	↑																									
↓	Degree of grip	↑																									
↓	-10°C... +110°C	↑																									
↓	Abrasion resistance	↑																									

Thin profile for improved degree of grip even under moist or dusty conditions; reduces sticking of smooth and dry conveyed goods; e.g. flat glass; price index: C

	Minigrip green, polyvinyl chloride <table border="1"> <tr> <td>s</td> <td>1.0</td> <td></td> <td></td> <td></td> <td></td> </tr> <tr> <td>Ø</td> <td>30</td> <td></td> <td></td> <td></td> <td></td> </tr> </table>	s	1.0					Ø	30					<table border="1"> <tr> <td>↓</td> <td>≈ 65 Shore A</td> <td>↑</td> </tr> <tr> <td>↓</td> <td>Degree of grip</td> <td>↑</td> </tr> </table>	↓	≈ 65 Shore A	↑	↓	Degree of grip	↑	<table border="1"> <tr> <td>↓</td> <td>-10°C... +110°C</td> <td>↑</td> </tr> <tr> <td>↓</td> <td>Abrasion resistance</td> <td>↑</td> </tr> </table>	↓	-10°C... +110°C	↑	↓	Abrasion resistance	↑
		s	1.0																								
		Ø	30																								
↓	≈ 65 Shore A	↑																									
↓	Degree of grip	↑																									
↓	-10°C... +110°C	↑																									
↓	Abrasion resistance	↑																									

Characteristics and application areas as Minigrip petrol blue; price index: B

	Pebbles rounded cone, blue, PVC (FDA) <table border="1"> <tr> <td>s</td> <td>2.5</td> <td></td> <td></td> <td></td> <td></td> </tr> <tr> <td>Ø</td> <td>30</td> <td></td> <td></td> <td></td> <td></td> </tr> </table>	s	2.5					Ø	30					<table border="1"> <tr> <td>↓</td> <td>≈ 65 Shore A</td> <td>↑</td> </tr> <tr> <td>↓</td> <td>Degree of grip</td> <td>↑</td> </tr> </table>	↓	≈ 65 Shore A	↑	↓	Degree of grip	↑	<table border="1"> <tr> <td>↓</td> <td>-20°C... +60°C</td> <td>↑</td> </tr> <tr> <td>↓</td> <td>Abrasion resistance</td> <td>↑</td> </tr> </table>	↓	-20°C... +60°C	↑	↓	Abrasion resistance	↑
		s	2.5																								
		Ø	30																								
↓	≈ 65 Shore A	↑																									
↓	Degree of grip	↑																									
↓	-20°C... +60°C	↑																									
↓	Abrasion resistance	↑																									

EU food compliant / FDA; e.g. for the conveyance of sausage and cheese; for narrow belts only single-row profiles with rounded cones; line distance approx. 8.5 mm; cone height approx. 1 mm; cone Ø approx. 3.5 mm; further design version in colour white; price index: E

	Supergrip white, PVC (FDA) <table border="1"> <tr> <td>s</td> <td>3.0</td> <td></td> <td></td> <td></td> <td></td> </tr> <tr> <td>Ø</td> <td>60</td> <td></td> <td></td> <td></td> <td></td> </tr> </table>	s	3.0					Ø	60					<table border="1"> <tr> <td>↓</td> <td>≈ 65 Shore A</td> <td>↑</td> </tr> <tr> <td>↓</td> <td>Degree of grip</td> <td>↑</td> </tr> </table>	↓	≈ 65 Shore A	↑	↓	Degree of grip	↑	<table border="1"> <tr> <td>↓</td> <td>-10°C... +100°C</td> <td>↑</td> </tr> <tr> <td>↓</td> <td>Abrasion resistance</td> <td>↑</td> </tr> </table>	↓	-10°C... +100°C	↑	↓	Abrasion resistance	↑
		s	3.0																								
		Ø	60																								
↓	≈ 65 Shore A	↑																									
↓	Degree of grip	↑																									
↓	-10°C... +100°C	↑																									
↓	Abrasion resistance	↑																									

EU food compliant / FDA; characteristics same as Supergrip petrol blue; profile same as Supergrip green, however less flexible; e.g. for the conveyance of food; price index: D

	PVC fishbone pattern, white, PVC (FDA) <table border="1"> <tr> <td>s</td> <td>3.0</td> <td></td> <td></td> <td></td> <td></td> </tr> <tr> <td>Ø</td> <td>60</td> <td></td> <td></td> <td></td> <td></td> </tr> </table>	s	3.0					Ø	60					<table border="1"> <tr> <td>↓</td> <td>≈ 65 Shore A</td> <td>↑</td> </tr> <tr> <td>↓</td> <td>Degree of grip</td> <td>↑</td> </tr> </table>	↓	≈ 65 Shore A	↑	↓	Degree of grip	↑	<table border="1"> <tr> <td>↓</td> <td>-15°C... +90°C</td> <td>↑</td> </tr> <tr> <td>↓</td> <td>Abrasion resistance</td> <td>↑</td> </tr> </table>	↓	-15°C... +90°C	↑	↓	Abrasion resistance	↑
		s	3.0																								
		Ø	60																								
↓	≈ 65 Shore A	↑																									
↓	Degree of grip	↑																									
↓	-15°C... +90°C	↑																									
↓	Abrasion resistance	↑																									

EU food compliant / FDA; distinct profile, here without runlet for improved degree of grip under wet conditions; small belts may only have a single row with the diagonal-cut profile; version with runlet on request; for the conveyance e.g. of wet flat glass; price index: E

6 COATINGS, CLEATS AND ADJUSTMENTS



6.2 SUBSEQUENTLY APPLIED COATINGS

POLYVINYL CHLORIDE (PVC) COATING MATERIAL

Picture of the coating	Designation, colour, material Standard thickness s [mm] Minimum pulley Ø [mm]	Hardness or density	Temperature resistance
		Degree of grip	Abrasion resistance

Profiled or structured



PVC saw tooth, white, PVC (FDA)

s	3.0				
Ø	60				

↓	≈ 65 Shore A	↑
↓	Degree of grip	↑

↓	- 15 °C... + 90 °C	↑
↓	Abrasion resistance	↑

EU food compliant / FDA; distinct profile for improved degree of grip even under moist and wet conditions; line contact; price index: D



PVC triangular profile, white, PVC (FDA)

s	3.0				
Ø	60				

↓	≈ 65 Shore A	↑
↓	Degree of grip	↑

↓	- 15 °C... + 90 °C	↑
↓	Abrasion resistance	↑

EU food compliant / FDA; medium size profile for improved degree of grip even under moist conditions; line contact; price index: D

Smooth or slightly structured

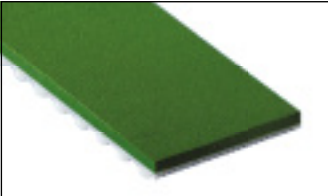

PVC foil green, polyvinyl chloride

s	2.0				
Ø	60				

↓	≈ 65 Shore A	↑
↓	Degree of grip	↑

↓	- 15 °C... + 90 °C	↑
↓	Abrasion resistance	↑

Characteristics and application areas same as PVC foil petrol blue, however slightly more oil and grease resistant; price index: C



PVC foil blue, PVC (FDA)

s	3.0				
Ø	80				

↓	≈ 65 Shore A	↑
↓	Degree of grip	↑

↓	- 20 °C... + 100 °C	↑
↓	Abrasion resistance	↑

EU food compliant / FDA; medium conveyance loads; further characteristics same as PVC foil petrol blue; price index: D



PVC foil white, PVC (FDA)

s	2.0	3.0			
Ø	60	80			

↓	≈ 65 Shore A	↑
↓	Degree of grip	↑

↓	- 20 °C... + 100 °C	↑
↓	Abrasion resistance	↑

EU food compliant / FDA; medium conveyance loads; further characteristics same as PVC foil petrol blue; price index: B - D

¹ Coatings of this thickness: no standard stock keeping

6 COATINGS, CLEATS AND ADJUSTMENTS



6.2 SUBSEQUENTLY APPLIED COATINGS

POLYVINYL CHLORIDE (PVC) COATING MATERIAL

Picture of the coating	Designation, colour, material Standard thickness s [mm] Minimum pulley Ø [mm]	Hardness or density	Temperature resistance
		Degree of grip	Abrasion resistance
Smooth or slightly structured			



APL plus, red, elastic PVC

s	2.0	3.0				
Ø	60	80				

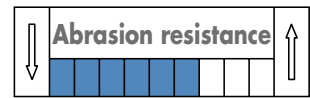
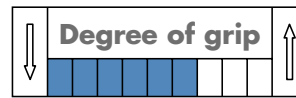
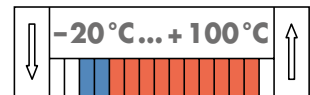

In contrast to other PVC foils, this coating is applied as a standard directly in the production process on the optibelt ALPHA LINEAR; welding to ALPHA V together with the coating possible without joint; continuously adhesive; simple and low-cost transport coating; profiles and further heights on request; price index: A

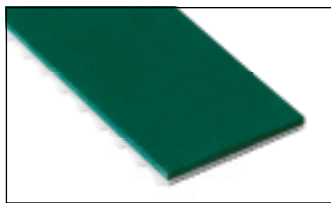

PVC foil petrol blue, polyvinyl chloride

s	1.0					
Ø	30					

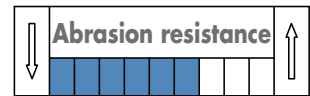
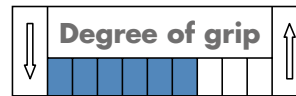
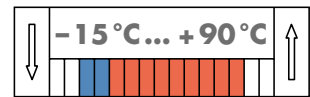

Due to its very smooth surface good adhesion characteristics, e.g. for the conveyance of paper and foils; conveyance of wood and plastics; packaging industry; discharge belts with medium load; price index: A

¹ Coatings of this thickness: no standard stock keeping
Further coating thicknesses and PVC designs on request; preselection see Table 6.2.1; characteristics and applications see Table 6.2.5; assumptions: "degree of grip" with slightly structured transport goods, "abrasion resistance" with relative movement; price index: A (low price) to E (high price), related to the smallest and largest standard thickness

6 COATINGS, CLEATS AND ADJUSTMENTS



6.2 SUBSEQUENTLY APPLIED COATINGS

COATINGS FOR SPECIAL REQUIREMENTS

Coatings for special requirements

The following coating materials considerably extend the application areas of coated conveyor belts through individual extraordinary characteristics, which cannot be achieved by belts with PA, PU, rubber or PVC coatings.

Picture of the coating	Designation, colour, material Standard thickness s [mm] Minimum pulley Ø [mm]	Hardness or density	Temperature resistance
		Degree of grip	Abrasion resistance
Smooth or slightly structured			

	PTFE, grey, polytetrafluorethylene s 0.3 Ø 200	Hardness n/a	-20°C... + 110°C
		Degree of grip	Abrasion resistance

Non-adhesive, e.g. for parts with fresh glue on the surface; high temperature and oil resistance for heated conveyed goods; but lower temperature resistance of the basic belt and the adhesive do not allow higher temperatures: Beware of short contact and cooling periods; very low degree of grip; sensitive surface, therefore relative motions have to be avoided; the open joint increases the minimum pulley diameter; price index: C, D

	TT60, grey, polyester fibre s 3.0 Ø 120	Hardness n/a	-10°C... + 120°C
		Degree of grip	Abrasion resistance

Antistatic characteristics for electronic parts; high temperature resistance for the conveyance of heated goods; but lower temperature resistance of the basic belt and the adhesive do not allow higher temperatures: Beware of short contact and cooling periods; price index: D

	Para fleece, beige, polyester fibre s 2.0 Ø 120	Hardness n/a	-10°C... + 130°C
		Degree of grip	Abrasion resistance

Conveyance of polished surfaces; high temperature resistance for the conveyance of heated goods; but lower temperature resistance of the basic belt and the adhesive do not allow higher temperatures: Beware of short contact and cooling periods; price index: C

	Chrome leather, grey, natural leather s 2.0 3.0 Ø 80 100	Hardness n/a	0°C... + 60°C
		Degree of grip	Abrasion resistance

Roughened, thus soft surface; good cutting resistance, high oil and grease resistance, also good degree of grip characteristics; e.g. for sharp-edged, oiled or greased parts; price index: C, D

6 COATINGS, CLEATS AND ADJUSTMENTS



6.2 SUBSEQUENTLY APPLIED COATINGS

COATINGS FOR SPECIAL REQUIREMENTS

Picture of the coating	Designation, colour, material Standard thickness s [mm] Minimum pulley Ø [mm]	Hardness or density	Temperature resistance
		Degree of grip	Abrasion resistance
Smooth or slightly structured			

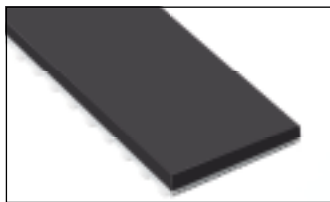

Viton, black, fluorinated rubber

s	2.0 ¹	3.0 ¹			
Ø	80	100			

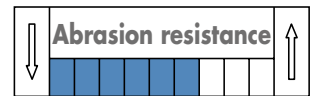
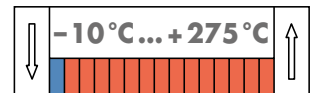
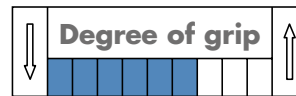

Extremely high temperature and oil resistance for the conveyance of heated goods; e.g. applications in solar cell production; but lower temperature resistance of the basic belt and the adhesive do not allow higher temperatures: Beware of short contact and cooling periods; price index: E

¹ Coatings of this thickness: no standard stock keeping
Further coating thicknesses and materials on request; preselection see Table 6.2.1;
price index: A (low price) to E (high price), related to the smallest and largest standard thickness

6 COATINGS, CLEATS AND ADJUSTMENTS

6.2 SUBSEQUENTLY APPLIED COATINGS



Price index overview

Table 6.2.6: Price index overview

Price index				
A (low price)	B	C	D	E (high price)
Polyamide				
PAZ				
PAR				
	PAZ/PAR			
		PAZ/PAR antistatic		
			PAR subsequently	
Polyurethane				
Reinforced top surface				
T2				
PU longitudinal groove fine				
	2.0 mm – Polythan D44 – 6.0 mm			
		2.0 mm – Celloflex – 8.0 mm		
		PU longitudinal groove		
		2.0 mm – PU foil 85 Shore A – 4.0 mm		
		2.0 mm – PU foil blue – 3.0 mm		
		6.0 mm – Sylomer R – 12.0 mm		
		2.0 mm – PU foil 92 Shore A – 4.0 mm		
			2.0 mm – Polythan D15 – 5.0 mm	
			PU foil 65 Shore A	
			Sylomer L	
			2.0 mm – PU-Smart – 12.0 mm	
			2.0 mm – PU 06 – 8.0 mm	
			6.0 mm – Sylomer M – 12.0 mm	
				Pointed cone
				Spike profile
Rubber				
	1.6 mm – NG red – 8.0 mm			
	3.0 mm – Porol – 15.0 mm			
		1.0 mm – RP 400 – 8.0 mm		
		1.5 mm – Linatex – 12,5 mm		
		Linaplus FGL		
		Supergrip black		
		4.0 mm – Correx beige – 12.0 mm		
		2.0 mm – EPDM – 6.0 mm		
			Linatrilite	
				Elastomer green
				Supergrip blue
Polyvinyl chloride				
APL plus				
PVC foil petrol blue				
Supergrip petrol blue				
	PVC longitudinal groove			
	Minigrip green			
		2.0 mm – PVC foil white – 3.0 mm		
		Minigrip petrol blue		
		PVC foil green		
		PVC cleats		
		Supergrip green		
			PVC triangular profile	
			PVC saw tooth	
			Supergrip white	
			PVC shark tooth	
			PVC foil blue	
				PVC fishbone pattern
				Pebbles rounded cone
Coatings for special requirements				
		Para fleece		
		2.0 mm – Chrome leather– 3 mm		
		PTFE		
			TT60	
				Viton

6 COATINGS, CLEATS AND ADJUSTMENTS



6.3 CAST COATINGS AND BASE BELTS,

optibelt ALPHA SRP, ALPHA TORQUE / ALPHA POWER

6.3 Cast Coatings and Base Belts, optibelt ALPHA SRP, ALPHA TORQUE / ALPHA POWER

The optibelt ALPHA SRP timing belts are different variations of the base belts optibelt ALPHA TORQUE / POWER, due to changed cast moulds, which are adjusted to a polyurethane coating for conveying purposes and have a length up to 900 mm or up to 2250 mm, depending on the design. Since no subsequent coating is necessary, but mould costs occur, the optibelt ALPHA SRP is especially suitable for comparatively small conveyor drives which are produced in large quantities. The optibelt ALPHA SRP can also be constructed as a flat belt.

The features and applications of the optibelt ALPHA SRP timing belts with cast polyurethane coating basically correspond to those of the optibelt ALPHA SPECIAL timing belts with subsequently applied polyurethane coating which is described in Subchapter 6.2.

The hardness of the cast polyurethane coatings and/or polyurethane base belts range from 60 Shore A to 95 Shore A. The temperature resistance corresponds to the optibelt ALPHA TORQUE / POWER timing belts: - 20 °C to + 70 °C. The optimum temperature range moves, with decreasing hardness, towards lower temperatures and vice versa. The optibelt ALPHA SRP cannot, as the optibelt ALPHA TORQUE / POWER, be directly manufactured with polyamide fabric and/or EU food compliant / FDA compliant polyurethane.

optibelt ALPHA TORQUE / POWER special designs

Belts, which were developed for power drives, can also be adjusted for conveying purposes, depending on the transport task, without any additional coating by changing the hardness, if required.

With comparatively large pulley diameters and low requirements regarding the degree of grip, the hardness of the cast polyurethane can be increased from the standard hardness 84 Shore A of the optibelt ALPHA TORQUE to up to 95 Shore A in order to increase the limited wear resistance of the thin top surface. With very low requirements regarding wear protection and conveying force, e.g. for very light transport goods, the grip of the base belt, e.g. for foil transport, can be increased in turn by selecting soft cast polyurethanes of e.g. 75 Shore A. Hardnesses below 60 Shore A are possible, but not recommended due to the low load bearing capacity of the tooth system of the base belt.

optibelt ALPHA SRP designs

The major benefits of the optibelt ALPHA SRP designs with cast polyurethane coating as opposed to timing belts with subsequently applied polyurethane coating are:

- Low unit costs with large unit quantities despite possible mould costs due to the production in one cast; the finished sleeve must only be cut open.
- Small coated timing belts or flat belts can be produced by mould fabrication.
- Coating without joints, no binding run direction
- High, consistent precision for production
- High strength of the connection between coating and base belt by cross-linking

Samples can be produced, if applicable, with subsequently coated optibelt ALPHA TORQUE / POWER base belts. The length restrictions and the joint should be taken into account here.

Production process

The production process of the optibelt ALPHA SRP designs basically corresponds to that of the optibelt ALPHA TORQUE / POWER whose existing mould cores can be used.

Prior to the casting of the timing belt sleeve, a high-strength, flexible tensile reinforcement is helically wound around interior mould core. The tensile reinforcement is supported on small production noses.

After casting, the timing belts are cut to width from the produced moulded sleeve as for the optibelt ALPHA TORQUE / POWER. Uncut steel tensile reinforcements protruding at the sides are separated manually so that the two ends lie in the frame without protruding at the sides. In the web region between the teeth, a small sleeve nose remains visible.

6 COATINGS, CLEATS AND ADJUSTMENTS



6.3 CAST COATINGS AND BASE BELTS,

optibelt ALPHA SRP, ALPHA TORQUE / ALPHA POWER

Casting: Base belt with reinforced top surface

The cast polyurethane is cast in one step between the moulded core and the special outside mould with a correspondingly increased inside diameter. The polyurethane used must also be adjusted regarding its hardness to

- the coating thickness and the pulley diameter of the drive,
- the force transmission in the tooth system,
- the degree of grip and
- the wear behaviour.

For the reinforced back, a separate special outside mould is required, which has been adjusted regarding dimensions and geometry. The increase of the outside mould or the reinforced top surface is shown in Figure 6.3.1 as an external blue jacket. Both moulds are fixed, in contrast to centrifugal casting (see below). The maximum belt length is 2250 mm. The colour of the optibelt ALPHA SRP is freely selectable.

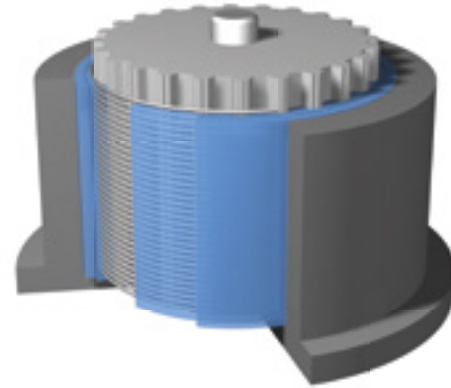

Figure 6.3.1: ALPHA SRP timing belt with reinforced top surface

Centrifugal casting: Base belt with polyurethane coating

In the processes to produce the optibelt ALPHA SRP with polyurethane coating, the whole mould, consisting of inside and outside mould, is set in rotation around the centre axis.

First, the polyurethane coating is moulded due to the centrifugal force which is represented in Figure 6.3.2 in green. Between the cylindrical outside mould of the produced coating and the mould core, the base belt, which is here represented in blue, is cast and moulded. The hardnesses of the linked polyurethanes of the coating and the base belt can be selected independently of each other and, as a result, adjusted optimally to the respective requirements.

The maximum belt length is 900 mm. The colour of coating and base belt is freely selectable.

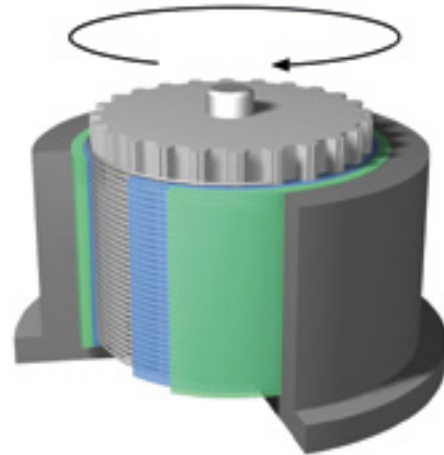

Figure 6.3.2: Moulding by centrifugal casting – ALPHA SRP timing belt with coating

Moulding, contours

With the aid of adjusted outside moulds, the coating surface can be freely shaped, e.g. in waves. In addition, vertical offset, e.g. for recesses, also see Chapter 6.6, can be implemented in the coating. For this purpose, care must be taken to ensure the demoulding capability. Further geometric and dimension adjustments are possible according to the processes described in Chapter 6.6.

Tolerances, surfaces

The total thickness tolerance of the optibelt ALPHA SRP timing belt with coating is ± 0.3 mm. With the aid of grinding, increased requirements for the total thickness tolerances can be met, see Subchapter 6.6. In addition, grinding can be used to roughen the surface. The length and width tolerances correspond to those of the optibelt ALPHA TORQUE / POWER timing belts, see Chapter 7.1.

6 COATINGS, CLEATS AND ADJUSTMENTS

6.4 SUBSEQUENTLY APPLIED CLEATS



6.4 Subsequently Applied Cleats

In transport drives, cleats enable a form-fit grip of the transport goods as opposed to coatings with a force-fit effect and serve e.g. for:

- Guidance in longitudinal direction and/or at the sides and alignment, if necessary
- Positioning on the conveyor belt
- Separation
- Enabling high accelerations and/or speeds
- Synchronising the transport goods with the base belt

These cleat functions can be implemented, depending on the application, also by coatings limited in thickness, which were adjusted accordingly in a subsequent step, e.g. by cross grooves. The dimension and geometry adjustment of transport belts is addressed in Subchapter 6.6.

For control tasks, cleats can e.g. be used to trigger mechanical or optical switches.

The shaping of the cleat is defined by the transport task and shape of the transport goods. The Optibelt cleat range offers a large number of cast blanks and cleats which can directly be used for many application purposes. Details of all currently available standard cleats can be found in the cleat selector on the Optibelt website. If none of these cleats is suitable, a suitable cleat can be produced

- from one or several blank cuts,
- from an existing cleat by mechanical processing,
- with a specifically manufactured injection mould.

The production using an injection mould is ideal for simple cleat shapes from medium quantities and for complex cleat shapes from smaller quantities.

The comparatively short lengths of the optibelt ALPHA SRP are a special case, as the base belt and cleats are cast in one step in a mould, see Subchapter 6.5.

Application examples

Transport drive examples with form-fit cleat belts are described in the following profiles.

Parallel conveyors

Parallel conveyors are preferably used for transport goods with a large width. In this case, additional lateral guide rails are not necessary. A parallel lateral arrangement of single belts additionally permits a reduced total belt width compared to an only central conveyor belt arrangement.

The installation space between the conveyor belts can be used for charging and/or withdrawal e.g. by a further parallel conveyor or for the arrangement of measuring sensors.

In addition, a supporting table can be used e.g. for

- heavy,
- curved,
- not stable in shape,
- flexible

transport objects in order to e.g. unload the base belt and/or ensure the parallel guidance after the takeover.

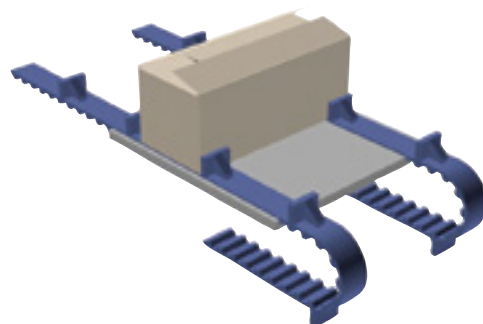

Figure 6.4.1: Parallel conveyor with supporting table

6 COATINGS, CLEATS AND ADJUSTMENTS

6.4 SUBSEQUENTLY APPLIED CLEATS



For heavy transport goods, the base belts can be embedded into the supporting table to such an extent, as shown in Figure 6.4.1 that only the cleats are in contact with the transport goods. On the one hand, this leads to an increased load on the cleats, however, on the other hand, the wear and temperature increase of the base belt are minimised.

For very wide and/or heavy transport parts, more than two conveyor belts with or without additional supporting tables can be employed. With the aid of a top surface support, the cleat can be additionally reinforced for increased loads.

Indexing conveyors

Indexing conveyors exhibit a stepwise movement. As shown in Figure 6.4.2, the belt can be loaded in a first step. At the intermediate stations, processing and/or assembly activities can be performed during the retention times. In the last step, the workpiece can be withdrawn. Short distances between the stations permit minimum cycle times and an optimum production time.

Indexing conveyors can be equipped with cleats, which serve directly as component carriers. Integrated pins and/or contour adjustments position the part precisely on the cleat.

Increased requirements regarding the design and precision of the component carriers – not their position – cannot always be met by the material polyurethane. In such cases, more precise component carriers e.g. metal can be attached to the cleat.

If the component carrier is to be fastened with attached parts to the cleat, e.g. a cleat with hole can be used. If the support of the component carrier is to be screwed directly to the cleat, glass fibre reinforced polyurethane cleats with embedded metal inserts are recommended.

Figure 6.4.3 shows the installation of component carriers with attached parts to two cleats with holes arranged in parallel, in series, or next to each other. Regarding the design, for the fastening to two cleats next to each other one of the two cleats has a long hole to enable a certain amount of leeway when positioning the cleats.

If the components are additionally fixed in the intended position e.g. by clamping jaws, mechanical processing steps can be performed. In addition, the component can be positioned more precisely than would be possible alone with the indexing belt.

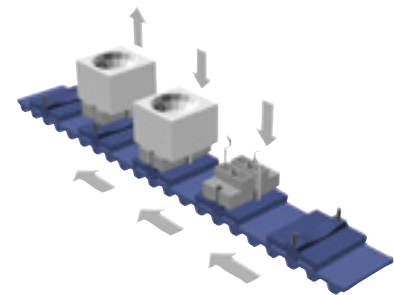

Figure 6.4.2: Cleats as workpiece carrier

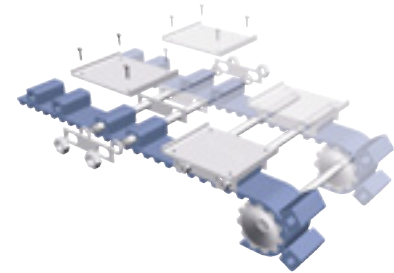

Figure 6.4.3: Cleats with holes, with attached parts and workpiece carrier

Cleat materials

Polyurethane cleat materials for permanent fastening

As cleat material, thermoplastic polyurethane, which can be welded and chemically linked, with the hardness of 92 Shore A is generally used. This material is likewise used to produce the optibelt ALPHA LINEAR/V and ALPHA FLEX timing belt. Furthermore, the transparent cleat materials can be used with the lower hardnesses 65 Shore A and 85 Shore A for an improved protection of sensitive goods, e.g. thin-walled cans. Slim cleat shapes of polyurethane with a lower hardness enable flexible cleats which may deflect in the case of an overload without being destroyed.

If in contrast to this, a hard and wear-resistant cleat is required, grey-white polyurethane of 98 Shore A can be used. An even higher cutting and abrasion resistance can be achieved by glass-fibre reinforced polyurethane.

6 COATINGS, CLEATS AND ADJUSTMENTS

6.4 SUBSEQUENTLY APPLIED CLEATS



Metal inserts are embedded in rigid glass-fibre reinforced polyurethane in a tear-resistant and anti-twist way. Glass-fibre reinforced polyurethane can only be welded, it cannot be chemically linked.

As a further cleat material, EU food compliant / FDA compliant blue or transparent polyurethane for the food and pharmaceutical industry with a hardness of 85 Shore A is available. Like the blue base belt of EU food compliant / FDA compliant polyurethane, the colour blue is preferred for cleats in the food industry.

At low ambient temperatures, the polyurethane hardens. For this reason, low hardnesses are recommended here. In turn, high hardnesses are recommended for high temperatures.

In general, individual cleat colours deviating from the standard can be produced when indicating the RAL number. Slight colour differences are possible between the batches. Glass-fibre reinforced cleats always include a light-grey colour portion due to the glass fibres. For small quantities and/or cleats, costs for colouring occur at the extruder.

Table 6.4.1: Standard polyurethane cleat materials

Material	Hardness	Colour	Code*	Characteristics	Application examples
PU	92 Shore A	white	P1	Standard material; identical with the base belt optibelt ALPHA V / FLEX	Covers over 90 % of the requirements, widely-used
PU	85 Shore A	trans- parent	P2	Compared to the standard softer and more flexible	Protection of sensitive goods; enables resilient cleats
PU	65 Shore A	trans- parent	P3	Compared to standard very soft and flexible; increases flexibility under cold conditions	Protection of sensitive goods; enables highly resilient cleats; preferably also for low temperatures
PU	98 Shore A	grey- white	P4	Compared to the standard harder, more rigid, stable to shape, resistant to cutting and wear	Cardboard and foil transport; preferably also at high temperatures
PU (FDA)	85 Shore A 85 Shore A	blue trans- parent	F1 F2	Base material PU (FDA) EU food compliant / FDA; preferred colour: blue	Packed and unpacked goods in the food industry; preferred application in the pharmaceutical industry
GFK (PU)	—	light grey	G1	Glass-fibre reinforced plastic on PU basis; very hard, cutting and wear resistant; cannot be linked chemically	Paper transport; for concertina cleats; for inserts; preferred also for high temperatures
for PU			see above	0 °C ≤ t ≤ 50 °C recommended temperature range under load	-15 °C ≤ t < 0 °C and 50 °C < t ≤ 80 °C permissible temperature range at reduced load

* Material code

6 COATINGS, CLEATS AND ADJUSTMENTS

6.4 SUBSEQUENTLY APPLIED CLEATS



Cleat materials for detachable fastening

As cleat material for detachable connections, thermoplastic polyurethanes, but also plastics or materials, which are not weldable or cannot be chemically linked such as aluminium, steel or stainless steel, can be used. Screw-on cleats and metal teeth can be directly screwed on to the base belt. Therefore, it is not necessary that the base belt is made from thermoplastic polyurethane. The fastening and detaching of the connection can be directly performed by the user.

All important details about this are described in this Subchapter in the profile "Detachable fastening methods".

Production of polyurethane cleats

Cleat blanks and cleats are manufactured in the injection moulding process, but they can be mechanically processed and connected.

Cutting of base plates and cleats, geometric dimensions

An economic and simple production method of single cleats is the cutting off the cleat blank. Figure 6.4.4 shows a base plate, which is available in the thicknesses 2, 3, 4, 5, 6, 8, 10 and 12 mm as cleat blank.

Continuous cuts generate simple cleat shapes, here e.g. a rectangular cleat.

Figure 6.4.5 shows a dimensioned rectangular cleat fastened on the base belt:

- Cleat width 32 mm
- Cleat height 10 mm
- Cleat thickness 5 mm

The dimensions of an applied cleat correspond to the base belt dimensions in the same plane ie:

- Cleat width measured in the same direction as belt width
- Cleat height measured in the same direction as belt height
- Cleat thickness measured in the same direction as belt length

Marking the cleat welding area and connection areas

When a cleat is welded on the base belt, polyurethane melts at a height of approx. 0.7 mm. This volume or height loss is called burn-off.

Figure 6.4.6 shows the burn-off depending on the selected welding area and the resulting maximum cleat sizes of

- 100 mm width and 49.3 mm height or
- 50 mm width and 99.3 mm height.

During cleat manufacture, a material allowance for the burn-off must be provided. Correspondingly, the welding area must always be specified for weld-on cleats according to customer requirements.

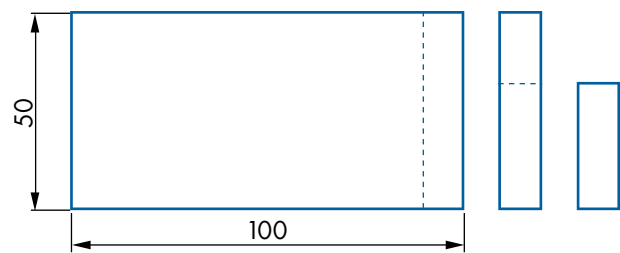

Figure 6.4.4: Base plate as cleat blank and cut out cleats

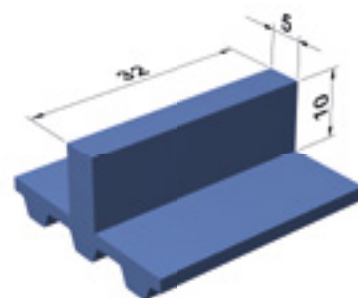

Figure 6.4.5: Dimensioned cleat

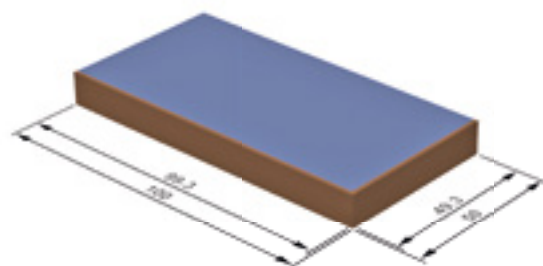

Figure 6.4.6: Cleat blank with burn-off at two possible weld-on areas

6 COATINGS, CLEATS AND ADJUSTMENTS

6.4 SUBSEQUENTLY APPLIED CLEATS



Figure 6.4.7 shows a trapezoidal cleat where the left lower area is to be used as weld-on area. This is indicated by the weld-on symbol with reference arrow. If no weld-on area is indicated in a drawing, because the cleat is e.g. chemically connected or screwed, no material allowance is intended for cleat manufacture accordingly.

The cleat area to be fastened should always be clearly defined. The fastening methods are described in detail in the following subchapter.

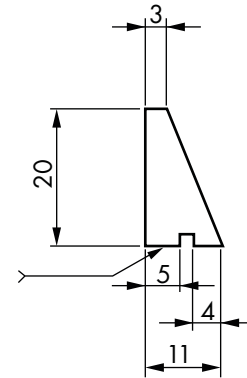

Figure 6.4.7: Trapezoidal cleat with weld-on symbol

Injection-moulded cleats and mechanical processing

The cleat blank or the injected cleat can be individually adjusted by mechanical processing regarding dimensions and geometry. For example, threaded inserts can be placed subsequently through drill holes.

In general, the following processing methods can be applied:

- Cutting
- Drilling
- Milling
- Water jet cutting
- Grinding

The following figures explain the manufacture and the preferred production procedure of polyurethane cleats by using an example.

For the production of up to medium quantities or samples, the left, roof-type trapezoidal cleat is milled from a rectangular cleat in Figure 6.4.8. For small to medium quantities, it is more economical to manufacture using injection moulds. Simple injection moulds can be produced for 2D outer contours up to a material thickness of 25 mm for each water jet cutting procedure within a short time. As a result, the left trapezoidal cleat can be injected up to a width of 25 mm. Due to the water jet diameter of 0.8 mm, the edges of a cleat must have an outside radius of at least 0.4 mm.

The right trapezoidal cleat consists of cuts of different base plates. The support is chemically linked to the rectangular cut and not attached to the base belt, also see profile "Polyurethane cleat groups and non detachable fastening methods" in this subchapter.

Combined cleat shapes, such as the left cleat in T shape in Figure 6.4.9 are preferably injection-moulded instead of chemically linked if high strength requirements are to be met.

For this reason, the right cleat with inserts, here e.g. with specifically high-loaded threaded pins, are preferably in situ instead of being screwed subsequently.

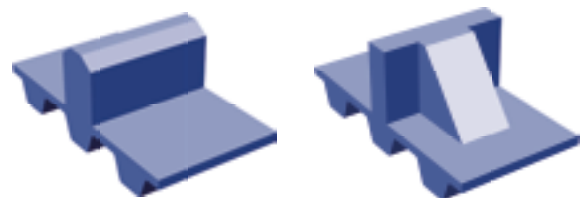

Figure 6.4.8: Trapezoidal cleats

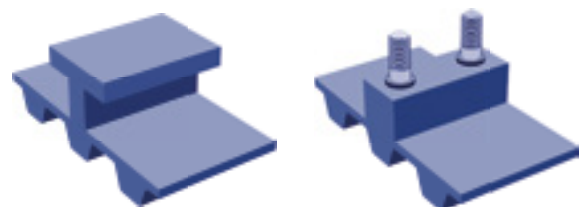

Figure 6.4.9: Cleat in T-shape and cleat with threaded pins as insert

6 COATINGS, CLEATS AND ADJUSTMENTS



6.4 SUBSEQUENTLY APPLIED CLEATS

A higher protection against tearing or twisting off of the inserts is additionally achieved by moulding with glass-fibre reinforced polyurethane in situ.

Glass-fibre reinforced cleats are preferably injection-moulded, since cutting is not possible in contrast to the other mechanical processing methods for GfK (PU).

Figure 6.4.10 shows a cleat with groove, which is difficult to clamp for mechanical processing such as milling. In the case of the round conical cleat (shown on the right) it also cannot be manufactured by mechanical processing. In both cases, production using an injection mould is reasonable even for small quantities.

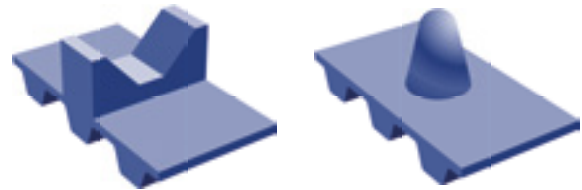

Figure 6.4.10: Grooved cleat with trapezoidal recess and round, conical cleat

Even if dimensional accuracy is required, the injection moulding process is suitable. Here, lower tolerances than in the subsequent mechanical processing can be implemented. Figure 6.4.11 shows cleats with through-hole, which have to be designed precisely for accommodating a component carrier.

On the right side, two cleats arranged in series are shown, which have to be fixed in a special clamp for welding. To further increase the accuracy for the alignment, the central profile of the welded, continuous cleat can be milled subsequently.

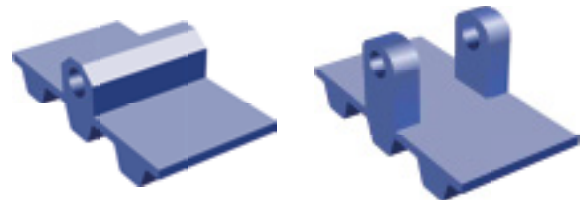

Figure 6.4.11: Hole-cleats with trapezoidal or rounded shape

Dimension tolerances

The dimensional accuracy of injection-moulded cleats basically depends on the shrinking behaviour of the selected polyurethane and the size and shape of the cleat. Injection-moulded cleats exhibit, in relation to dimension tolerance, a tolerance of up to ± 0.3 mm. For example, the width of a cleat blank, see Figure 6.4.6, with the dimensions $100 \times 50 \times 10$ mm can be between 99.7 mm and 100.3 mm. Smaller tolerances can be implemented depending on the size of the dimension and the cleat and determined for the individual case.

In Subchapter 6.6 "Adjustment through mechanical processing", the above indicated processing methods and in part the tolerances that can be realised, related to base belt, coatings and cleats, are described. The dimensional accuracy of mechanically processed cleats significantly depends on the processing procedure, the hardness of the selected polyurethane and the stability through the cleat shape. Mechanically processed cleats have, related to the dimension tolerance, a tolerance of up to ± 0.5 mm. Smaller tolerances can be achieved depending on the cleat and for the individual case.

A further condition for these tolerances is, the clamping possibility of the cleat. The clamping possibility depends on the cleat size, the original shape of the cleat to be processed and the intended shape to be achieved by subsequent processing.

Cleat design	Dimension tolerance
Injection-moulded cleat	± 0.3 mm
Mechanically processed cleat	± 0.5 mm

6 COATINGS, CLEATS AND ADJUSTMENTS

6.4 SUBSEQUENTLY APPLIED CLEATS



Polyurethane cleat groups and non detachable fastening methods

Cleats can be connected depending on the load, design, dimension, material and base belt by different fastening methods.

Thermoplastic polyurethane cleats are permanently fastened on optibelt ALPHA V or ALPHA FLEX timing belts by



- welding or
- chemical linking.

Here, the fastening method of chemical linking for flat and thin-walled cleats or an increased requirement regarding the height tolerance is preferred. Both methods are described in this chapter.

Polyurethane cleat groups, cleat order designation

Injection moulded cleat blanks or cleats are sorted according to shape and/or function in cleat groups.

Examples of injection-moulded cleats of the standard cleat assortment are represented within the pertaining clamp group consistently on the T10 profile and possible applications are described. Details of all shapes and dimensions of all currently available standard cleats can be found in the cleat selector on the Optibelt website. The corresponding cleat drawing can be downloaded in PDF format or for design drawings in DWG or DXF format. Each cleat shape is defined through a serial number which also specifies the injection mould.

Rectangle		
Rectangular cleat, with a small chamfer, if applicable, slightly curved shape and/or small opening at the weld-on area		
Characteristics and Application		
Low-priced and most widely used cleat for simple transport tasks; it has a comparatively low bearing capacity because of its slim shape and upright position; Fibre width ≤ 1 mm, outside radius $R \leq 0.5$ mm	 WKZ-0001	 WKZ-0056

Picture similar to standard cleats; WKZ-0001 with width 100 mm and WKZ-0056 with width 50 mm and without fibres

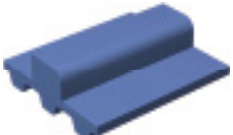

Round		
Cleat with curved shape or semicircular or cylindrical shape		
Characteristics and application		
To protect the transport goods, e.g. during charging; outside radius $R > 0.5$ mm; vertically standing cylindrical cleats (without picture) can be produced in up to medium quantities of optibelt RR round belts; cylindrical cleats with small diameters are chemically linked	 WKZ-0014	 WKZ-0023

Picture similar to standard cleats; WKZ-0014 and WKZ-0023 with width 100 mm



6 COATINGS, CLEATS AND ADJUSTMENTS

6.4 SUBSEQUENTLY APPLIED CLEATS



T-shape, L-shape	
Cleat with one or two projections at the side	
Characteristics and application	
<p>T-shape, e.g. to increase the cleat width beyond the base belt for better guidance; for reduced area loading for sensitive goods; for vertical fixing;</p> <p>L-shape, e.g. to increase the contact area as simple component carrier or for takeover already in the curve</p>	
	
WKZ-0096	WKZ-0143



Picture similar to standard cleats; WKZ-0096 with higher and wider web

Fan-shaped	
Very flat, fan-shaped cleat, partly with rounded edges and corners	
Characteristics and application	
E.g. to produce multi-layer hygiene articles such as nappies or sanitary pads	
	
WKZ-0043	WKZ-0044

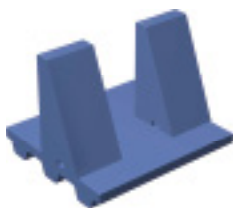
Picture similar to standard cleats; WKZ-0043 with thickness 2.5 mm and WKZ-0044 of thickness 3.0 mm, each 125 mm high

Trapezoidal shape	
Cleat with 4 areas with at least one inclined area; partly for protection; reduced welding area in most cases	
Characteristics and application	
<p>E.g. for fixing cylindrical objects between serial cleats such as WKZ-0127; with inclined area on one side e.g. opposite arrangement of the cleat; for use of the vertical area to support the cleat such as WKZ-0107; medium recess e.g. for withdrawal through gripper; area width > 1 mm</p>	
	
WKZ-0127	WKZ-0107

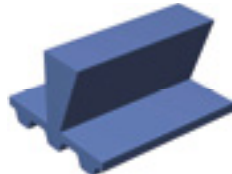
Picture similar to standard cleats; WKZ-0127 with width 100 mm

V-trapezoid	
Trapezoidal cleat, see above, with tapered base	
Characteristics and application	
E.g. for inclined conveyors for improved, safer grip; vertical fixing for opposite arrangement similar to dovetail	
	
WKZ-0016	WKZ-0230

Picture see standard cleats; WKZ-0016 and WKZ-0230 each with width 100 mm

6 COATINGS, CLEATS AND ADJUSTMENTS

6.4 SUBSEQUENTLY APPLIED CLEATS

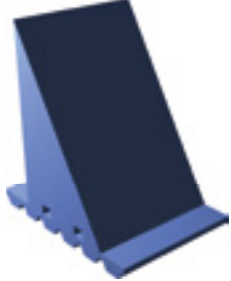

Triangle		
Cleat with 3 areas with at least one inclined area; reduced welding area in most cases		
Characteristics and application		
E. g. for fixing cylindrical objects between serial cleats, see WKZ-0073; in case of one-sided inclined area e. g. opposite arrangement of cleats, see WKZ-0307; for use of vertical area to support the cleat; minimum contact with transport goods on the cleat; WKZ-0073 is chemically linked	 <p style="text-align: center;">WKZ-0073</p>	 <p style="text-align: center;">WKZ-0307</p>

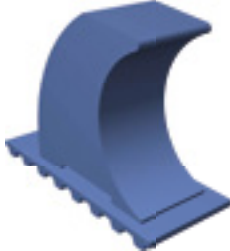
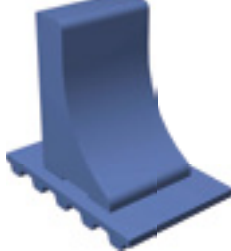

Picture similar to standard cleat; WKZ-0073 with width 100 mm; to WKZ-0307: central welding area

Concave, convex		
Cleat with continuously concave and/or convex area or areas		
Characteristics and application		
E. g. for vertical transport of shafts, see cleat WKZ-0103 or for protecting transport of sensitive cylindrical objects such as thin-walled cans, see cleat WKZ-0041	 <p style="text-align: center;">WKZ-0103</p>	 <p style="text-align: center;">WKZ-0041</p>

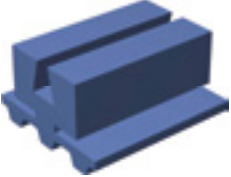
Picture similar to standard cleat; WKZ-0041 with width 101.6 mm

Groove		
Cleat with grooved recess or grooved recesses		
Characteristics and application		
E. g. for fixing cylindrical transport goods depending on the arrangement crosswise or lengthwise along the belt; see WKZ-0019 for longitudinal alignment; see WKZ-0135; dovetail groove, for additional vertical fixing	 <p style="text-align: center;">WKZ-0019</p>	 <p style="text-align: center;">WKZ-0135</p>

Picture similar to standard cleat; WKZ-0135 with width 80 mm



Hole		
Cleat with one or several holes or long holes		
Characteristics and application		
E. g. to fasten attached parts of component carriers	 <p style="text-align: center;">WKZ-0030</p>	 <p style="text-align: center;">WKZ-0059</p>

Picture similar to standard cleat; WKZ-0030 with width 100 mm

6 COATINGS, CLEATS AND ADJUSTMENTS



6.4 SUBSEQUENTLY APPLIED CLEATS

Insert		
Cleat moulded with one or several inserts such as threaded sleeves or pins		
Characteristics and application		
E.g. for fastening attached parts of component carriers with threaded pin or pins, see Figure 6.4.9; with threaded sleeves such as WKZ-0040; material mostly GFK (PU), G1, see Table 6.4.1; with eccentric threaded sleeve for fixing at the side, therefore without GFK, of a slid-on attached part, see WKZ-0093	 WKZ-0040	 WKZ-0093

The above cleats are all represented without welding bead, where these would be visible for technical and economic reasons, such as in the area of the recesses of cleat WKZ-0040. Exterior recesses between cleat and belt are defined ≤ 2 mm as clearing. The sequence of cleat groups is based on the level of specialisation; the special shapes and functions may also include all simpler cleat groups.

Table 6.4.2: Cleat groups of injection-moulded cleat blanks or cleats

Shape and function of the cleat											
Simple							→	Special			
Rectangle	Round	T-shape, L-shape	Fan-shaped	Trapezoidal shape	V-trapezoid	Triangle	Concave, convex	Groove	Hole	Insert	

E.g. rectangular cleats with top surface support are hence assigned to the trapezoidal group. If this trapezoidal cleat exhibited e.g. an additional lengthwise or crosswise groove, the cleat injection-moulded like this would be assigned to the cleat group, "Groove".

The dimensions in the cleat drawings depend on the shrinking behaviour of the respective polyurethane design and always refer only to the indicated materials.

Order designation of an optibelt ALPHA SPECIAL

Order designation of an optibelt ALPHA SPECIAL, consisting of base belt and cleat, see trapezoidal cleat WKZ-0107 on belt as order example:

Selected base belt:	optibelt ALPHA V 32 T10/990-ST-PAZ
Selected cleat:	Trapezoidal cleat WKZ-0107
Description:	3 cleat groups of 2 pcs., cleat welded over tooth flush right and flush left according to the cleat pitch of 330 mm
Order designation of the cleat belt:	1 pc. optibelt ALPHA V SPECIAL 32 T10/990-ST-PAZ with 6 cleats WKZ-0107 in 3 cleat groups of 2 pcs., flush right and flush left welded over tooth according to cleat pitch 330 mm

As the cleat designation WKZ-0107 indicates that the weld-on area is arranged on the vertical profile of the cleat, this does not need to be indicated in the order text. Should the orientation of the cleat not be uniform, this has to be indicated.

6 COATINGS, CLEATS AND ADJUSTMENTS

6.4 SUBSEQUENTLY APPLIED CLEATS



Permanent fastening method welding, free support

Depending on the contour, thermoplastic polyurethane cleats can be connected permanently by welding with the thermoplastic polyurethane belt. When heating the cleat and base belt, polyurethane melts in the area of the welding. When placing the cleat on the base belt, part of this material migrates outwards. A welding bead forms around the welding point. The welded cleat loses approx. 0.7 mm in height. This height loss is called burn-off and is taken into account during cleat production.

Figure 6.4.12 shows a cleat with support directly after welding on the base belt. The welding bead formed on the transport side would impede the complete contact at the side, the safe support and the precise positioning of the transport goods. Figure 6.4.13 shows the deburred cleat where the transport goods are in full contact at the side. Therefore, continuously free cleat areas at right angles to the belt top surface and in longitudinal direction of the belt are always cleaned after welding.

In other cases, where the angle is less than or greater than 90°, it has to be determined if deburring is required, and if so, a suitable tool to fully remove the welding bead is required. The deburring of welding beads on cleats with glass-fibre reinforcement should be avoided in general. By a corresponding recess in the weld area, a fault in the contact with the transport goods can be prevented by the forming welding bead.

As shown in the pictures above, the cleat support is welded on the base belt without any restriction in function. The pressure forces acting on the area between cleat support and base belt can be transferred nevertheless. The support relieves the cleat from bending and lifts off from the base belt during the rotation around the pulley to touch down again afterwards. Figure 6.4.13 shows the moment after the rotation when the support has touched down almost completely. A cleat with support should only be loaded, if possible, once the support has fully touched down.

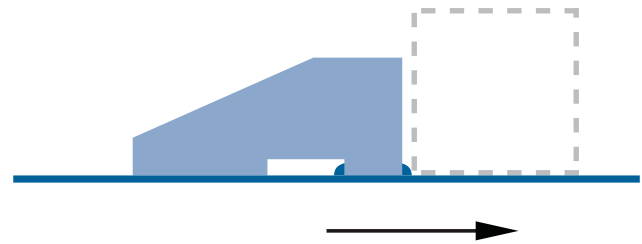

Figure 6.4.12: Cleat with support and welding beads on the straight line (arrow)

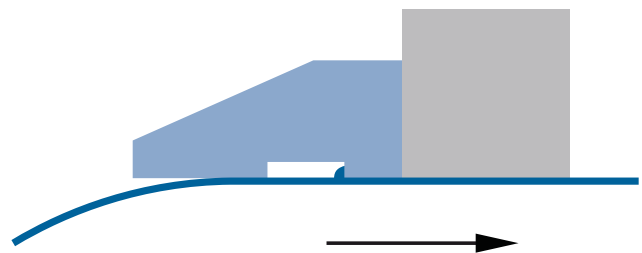

Figure 6.4.13: Cleat with support without front welding beat in the transition from the diversion

Permanent fastening method chemical linking

During chemical linking, the thermoplastic polyurethane cleat is permanently connected with the thermoplastic polyurethane base belt. Since no additional material is added for chemical linking, it does not represent an adhesive technology.

Chemical linking is preferably used for flat and thin-walled cleats, as in contrast to the welding at the chemical linking point no material melts off and no burn-off occurs. In general, the original cleat height is maintained so that smaller height tolerances can be achieved than with welding. In contrast to welding, no welding beads form during chemical linking. If these enhanced requirements do not need to be fulfilled, the welding method of fastening even with the possibly time-consuming removal of the welding beads, e.g. in the case of undercuts, is to be preferred, as it is overall less time-consuming and therefore less expensive.

The above mentioned thermoplastic polyurethanes can be chemically linked. Only glass-fibre reinforced polyurethane cannot be chemically linked.

6 COATINGS, CLEATS AND ADJUSTMENTS

6.4 SUBSEQUENTLY APPLIED CLEATS



Position in relation to tooth, number of teeth on pulley and fastening strength

The flexibility of a timing belt for its run around the pulleys is highest in the flat web area between the teeth and lowest in the area of the higher and more rigid teeth.

Accordingly, the cleat fastening, which causes a proportionally increasing rigidity of the cleat timing belt with an increasing fastening strength, should be arranged opposite a belt tooth, if possible, see e.g. Figure 6.4.14.

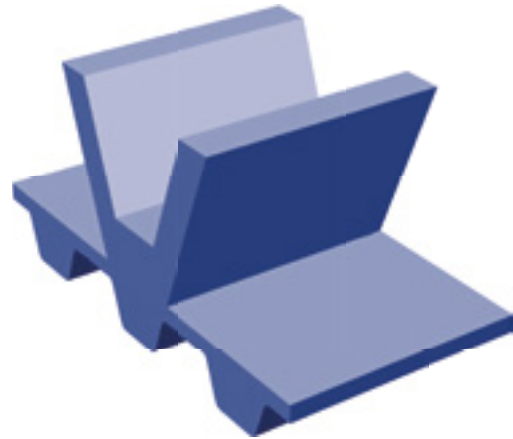

Figure 6.4.14: Optimum cleat position directly opposite the belt tooth

In this case

- the cleat pitch follows the tooth pitch or a multiple of the tooth pitch,
- the flexibility is minimally restricted or
- the minimum pulley diameter increases the least or
- the load on the fastening is kept small during bending.

If the cleat pitch does not correspond to the tooth pitch or a multiple thereof, the cleat must also be partly fastened above the web. As a result, the flexibility of the timing belt is additionally restricted and the potential minimum pulley diameter is increased again. Accordingly, the two cases are illustrated in the following Table 6.4.3.

Table 6.4.3: Number of teeth on pulley and fastening strength of welded and chemically linked cleats

Profile	Number of teeth on pulley													
	20		25		30		40		50		60		100	
	Recommended maximum fastening strength [mm] for welded or chemically linked cleat with opposite fastening position													
	Tooth	Web	Tooth	Web	Tooth	Web	Tooth	Web	Tooth	Web	Tooth	Web	Tooth	Web
T5, AT5	5	2	6	2	6	3	8	4	9	6	10	8	12	10
T10, AT10	8	3	9	4	10	4	12	6	14	9	15	12	20	20
T20, AT20	12	5	13	5	15	6	18	6	20	12	23	20	30	30
5M	5	2	6	2	6	3	8	4	9	6	10	8	12	10
8M	6	3	7	3	8	4	10	5	12	7	13	10	16	16
14M	10	4	11	5	12	6	15	6	16	10	18	16	25	25
XL	5	2	6	2	6	3	8	4	9	6	10	8	12	10
L	6	3	7	3	8	4	10	5	12	7	13	10	16	16
H	8	4	9	5	10	6	12	7	14	10	15	12	20	20
XH	13	2	14	5	15	6	18	8	20	12	23	20	30	30

If the thickness of a selected cleat is too large, the fastening thickness can be reduced by one or two recesses, see Profile "Polyurethane cleat groups, cleat order designation" and there e.g. cleats WKZ-0056, WKZ-0143, WKZ-0107, WKZ-0307, WKZ-0103 and others. The resulting load increase on the connection point can be compensated, if required, by a top surface support or a support on both sides, see WKZ-0040.

6 COATINGS, CLEATS AND ADJUSTMENTS

6.4 SUBSEQUENTLY APPLIED CLEATS



Position and pitch tolerances

If the cleat pitch corresponds to the tooth pitch or a multiple thereof, the position tolerance from the cleat centre to the tooth centre is ± 0.25 mm. If the cleat pitch does not correspond to the tooth pitch or a multiple thereof, the position tolerance between cleat and tooth is ± 0.5 mm. For cleat pitches from approx. 100 mm, the length tolerance of the base belt should always be included in the cleat pitch tolerance.

Table 6.4.4: Cleat pitch tolerance

Cleat pitch	Cleat pitch tolerance	
	Position tolerance to tooth	Base belt length tolerance
corresponds to the tooth pitch or the multiple of the tooth pitch	± 0.25 mm	depending on the base belt, see data sheet, mostly ± 0.5 mm/m, related to the respective cleat pitch
does not correspond to the tooth pitch or the multiple of the tooth pitch	± 0.5 mm	
Cleat pitch tolerance = position tolerance to tooth + base belt length tolerance		

For the length tolerance in width direction, the width tolerance must be included, see Chapter 7. For the pitches of 5 mm to 10 mm, this is ± 0.5 mm.

Direction	Position tolerance
Crosswise or width direction	± 0.5 mm for pitch of 5 to 10 mm

Example:

The tooth pitch t_N is supposed to be 200 mm. The base belt optibelt ALPHA V T10 profile with a length tolerance of ± 0.5 mm/m is selected. The cleat is welded above the tooth.
 Cleat pitch tolerance: ± 0.25 mm + $(\pm 0.5$ mm/1000 mm) \cdot 200 mm = ± 0.35 mm
 Restricted cleat pitch tolerances are possible on request.

Belt length and cleat pitch

The conveying distance of the above example should be at least 1500 mm. The selected timing belt pulleys have at least the number of teeth z of 24. z_{\min} , $L_{w \min}$ see base belt data sheet and Table 6.4.3. This leads, with a tooth pitch t of 10 mm, to the following minimum belt length:

$$L_w = 2 \cdot s + z \cdot t \quad \text{with } L_w [\text{mm}] \geq L_{w \min} (\text{base belt}), s [\text{mm}], t [\text{mm}], z = z_1 = z_2 \geq z_{\min}$$

$$L_w = 2 \cdot 1500 \text{ mm} + 24 \cdot 10 \text{ mm} = 3240 \text{ mm} \quad \geq 700 \text{ mm}, z \geq 12, \text{ optibelt ALPHA V 50 T10}$$

The belt length must correspond to a full multiple n_N of the cleat pitch t_N :

$$n_N = \frac{L_w}{t_N}; L_w = n_N \cdot t_N \quad \text{with } L_w [\text{mm}] \geq L_{w \min} (\text{base belt}), t_N [\text{mm}], n_N = 1, 2, 3, \dots$$

$$n_N = \frac{3240 \text{ mm}}{200 \text{ mm}} = 16.2 \quad \text{selected } 17 \quad \text{Belt length } L_w = 17 \cdot 200 \text{ mm} = 3400 \text{ mm} \geq 700 \text{ mm}$$

If the cleat pitch t_N , e. g. of 167 mm, does not correspond to a multiple of the tooth pitch t , the product leads to the smallest belt length $L_{w \min}$ or the belt length L_w , which can also be a multiple thereof.

$$L_{w \min} = t \cdot t_N \quad \text{with } L_w [\text{mm}] \geq L_{w \min} (\text{base belt}), t [\text{mm}], t_N [\text{mm}]$$

$$L_w = L_{w \min} \cdot n_{Lw} = t \cdot t_N \cdot n_{Lw} \quad \text{with } n_{Lw} = 1, 2, 3, \dots$$

$$L_w = 10 \cdot 167 \text{ mm} \cdot 2 = 3340 \text{ mm} \quad \text{with } n_{Lw} = 2 \text{ selected}, \geq 700 \text{ mm}, \text{ optibelt ALPHA V 50 T10}$$

6 COATINGS, CLEATS AND ADJUSTMENTS

6.4 SUBSEQUENTLY APPLIED CLEATS



Screw-on cleat

Figure 6.4.15 shows the connecting dimensions of a screw-on cleat for fastening onto an individual metal tooth. Depending on the metal tooth, the centre distance for 25, 32 and 50 mm standard widths varies between 15, 20 or 25 mm. For the design of the screw-on cleat, the connecting dimensions must be taken into account to ensure that the belt runs properly.

Depending on the cleat, the use of hexagonal socket flat head screws, for example, as per DIN 7984 is recommended for the screw connection.

The screw-on cleats are also grouped into different types according to their shape and function, just the same as for the polyurethane cleats that are used for permanent connections. These are described previously, such as in Table 6.4.2.

Screw-on cleats may consist, for example, of polyamide (PA) or glass-fibre reinforced polyurethane.

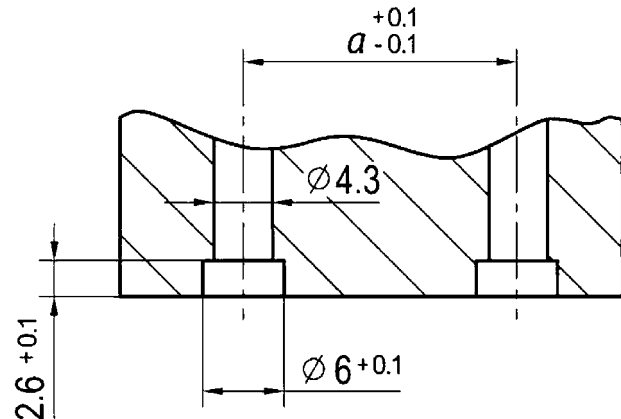

Figure 6.4.15: Connecting dimensions of a screw-on cleat with centre distance a depending on metal tooth

Table 6.4.5: Standard screw-on cleat materials

Material	Hardness	Colour	Code*	Characteristics	Application examples
GFK (PU)	–	light grey	G1	glass-fibre reinforced plastic on PU basis; very hard, high cutting resistance and abrasion resistance 0 °C to 50 °C maximum temperature range under load	paper conveying; for highly loaded cleats or cleat connections; also for high temperatures –15 °C to 80 °C temperature range under low load
Polyamide	–	black	PA1	high strength, rigidity and toughness compared to non-reinforced plastic 0 °C to 80 °C maximum recommended temperature range under load	low to medium cleat loads in standard applications –10 °C to 100 °C temperature range under low load

* Material code; further materials and material codes e.g. steel: ST, aluminium: AL, stainless steel; RF

Screw-on cleats of other materials such as aluminium, steel or stainless steel can be individually produced on request.

6 COATINGS, CLEATS AND ADJUSTMENTS

6.4 SUBSEQUENTLY APPLIED CLEATS



Screw connection using a metal tooth

A screw connection using a metal tooth as an insert is mainly suitable for profile sizes from AT10 upwards. In this case, the tooth is removed from the fastening point in the factory and a metal tooth is inserted into a metal wall plug in the through holes provided for them. The metal tooth is smaller in size than the polyurethane tooth so that it does not come into contact with the timing belt pulley when the tooth engages with it. The missing polyurethane tooth does not contribute to any transmission of power. It is also possible, however, to provide other centre distances, threads and materials for different belt profiles and widths on request.

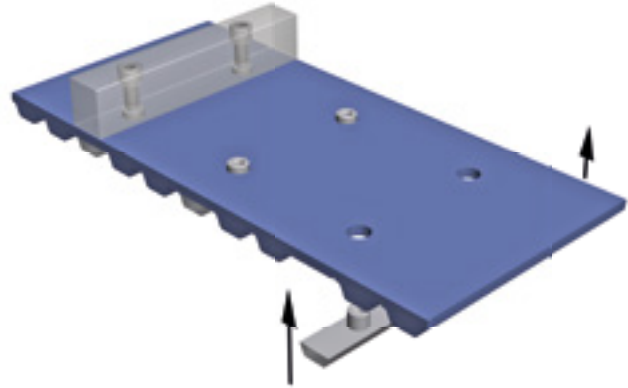

Figure 6.4.16: Installation of metal tooth and screw-on cleat

Overview of cleat fastening methods

Table 6.4.6: Cleat fastening methods and characteristics

Fastening method	Disconnection	Material	Base belt, profiles	Height tolerance	Strength	Minimum timing belt pulley diameter
Welding	permanent	PU ¹ , PU-GFK	optibelt ALPHA V / FLEX	+ / - - 0.5 mm	+	depending on weld thickness
Chemical bond	permanent	PU ¹	optibelt ALPHA V / FLEX	+ ± 0.2 mm	+ / -	depending on bond strength
Screw connection, metal tooth	detachable	freely selectable	optibelt ALPHA V, ALPHA FLEX, ALPHA TORQUE / POWER with AT10 profile; other profiles on request	+ PU: ± 0.2 mm ++ e.g. metal	++	in the same way as standard base belt + 10 teeth

¹ Thermoplastic polyurethanes, such as PU (FDA), except PU GFK

Where stringent total height tolerance requirements must be met for the base belt and cleat, the base belt height tolerance must be taken into account in every case. It can be reduced prior to fastening the cleat by grinding the base belt to ± 0.15 mm. The overall height tolerance is the sum total of individual tolerances.

6 COATINGS, CLEATS AND ADJUSTMENTS



6.5 CAST CLEATS AND BASE BELTS, optibelt ALPHA SRP

6.5 Cast Cleats and Base Belts, optibelt ALPHA SRP

The functions and applications of the cast cleats of the ALPHA SRP generally correspond to those of subsequently added cleats which are described in Subchapter 6.4. The special advantages, but also the restrictions, which result from casting as the production process, are described in this chapter.

The major advantages of the optibelt ALPHA SRP timing belts with cleats as opposed to optibelt ALPHA V and ALPHA FLEX with subsequently applied cleats are:

- Low unit costs with large unit quantities despite possible mould costs due to the production in one cast; the finished sleeve must only be cut open.
- Simple production of small cleat belts by mould production
- High number of cleats on smallest space
- Finely developed, precisely shaped cleat geometries through liquid cast polyurethane
- Reproducible high precision
- High strength between cleat and base belt by complete cross-linking

In contrast to the cleat timing belt based on the base belt optibelt ALPHA V or ALPHA FLEX, the maximum transport distance is clearly limited. The maximum belt lengths of the optibelt ALPHA SRP are 900 mm or 2250 mm, depending on the production procedure. For cost reasons, belt lengths of the standard assortment of the optibelt ALPHA TORQUE / POWER timing belts are used, if possible. In addition, the cleat shapes and functions are less versatile due to the demoulding of the whole optibelt ALPHA SRP.

For samples without tool costs, base belts of the product groups optibelt ALPHA TORQUE / POWER, ALPHA FLEX or ALPHA V can be used, depending on the selected belt length, as far as profile, length and width are available accordingly.

In the case of a non-weldable, cast base belt, a cleat connection can likewise be implemented by applying a corresponding PU layer. The subsequent "connection strength" between cleat and belt of an optibelt ALPHA SRP is not achieved by any of the potential sample designs.

Production, casting process

Compression casting, lengths up to 2250 mm

The manufacturing process of the optibelt ALPHA TORQUE / POWER and ALPHA SRP with cleats is basically identical. In both cases, a sleeve is moulded with the aid of a toothed inside mould and an outside mould. For the production of an ALPHA SRP with cleats, the cylindrical and smooth outside mould of the optibelt ALPHA TORQUE / POWER timing belts is replaced by an outside mould with the required negative contours of the cleats, see Figure 6.5.1.

The existing inside moulds for optibelt ALPHA TORQUE / POWER timing belts up to lengths of 2250 mm can be used here depending on the

- demoulding capability,
- width and width tolerance,
- precision of the cleat.

The hardness of the cleat corresponds to the hardness of the base belt. If the desired cleat hardness deviates significantly from the standard base belt hardness of 84 Shore A, the changed characteristics of the base belt, related to the flexibility and wear behaviour must be included in the design.

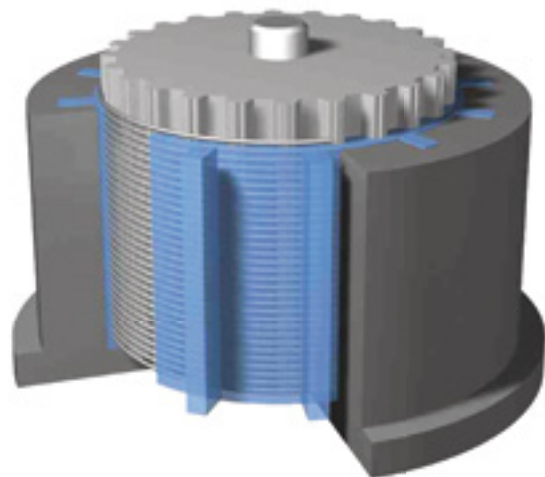

Figure 6.5.1: Shaping of cleats and belts by compression casting

6 COATINGS, CLEATS AND ADJUSTMENTS



6.5 CAST CLEATS AND BASE BELTS, optibelt ALPHA SRP

Centrifugal casting, lengths up to 900 mm

In the centrifugal casting process to produce the optibelt ALPHA SRP with cleats, the whole mould, consisting of an inside and outside mould, is set into rotation around the centre axis. The benefit here is that through the centrifugal force the finest cleat contours are formed and that, if required, polyurethanes of a varying hardness and colour, see Figure 6.5.2 can be used for cleats and base belts. For example, cleats of a high flexibility from a hardness of 55 Shore A or of a high stability in shapes up to a hardness of 95 Shore A can be manufactured, without changing the usual characteristics of the base belt e.g. with the standard hardness of an optibelt ALPHA TORQUE of 84 Shore A. In contrast to the compression casting process, the maximum production length is limited to the occurring centrifugal forces to 900 mm.

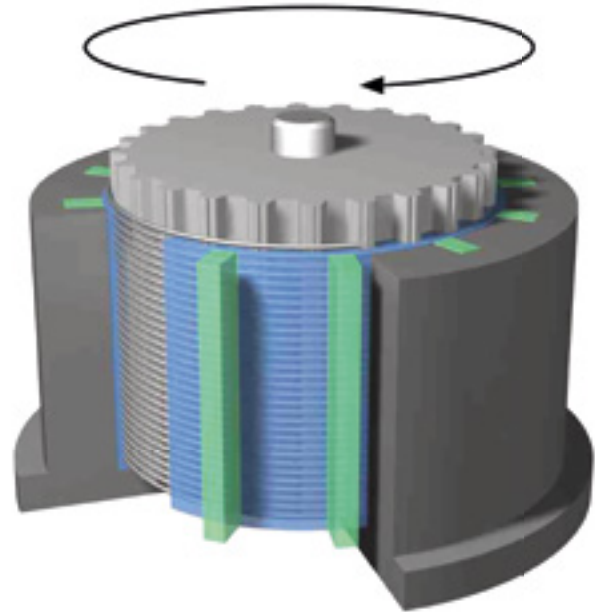

Figure 6.5.2: Shaping of cleats and belts by centrifugal casting

Casting process	Length
Compression casting	50 mm \longleftrightarrow 2250 mm
	see standard lengths per profile; smaller, other lengths on request
Centrifugal casting	100 mm \longleftrightarrow 900 mm
	smaller and intermediate lengths on request

Cast polyurethane hardnesses		
Lowest hardness	Standard hardness	Maximum hardness
55 Shore A	84 Shore A ALPHA TORQUE	95 Shore A

The tolerance for the hardness of the cast polyurethane is ± 2 Shore A. The lowest hardness of 55 Shore A is tolerated with + 3 Shore A and the maximum hardness is tolerated with - 3 Shore A.

6 COATINGS, CLEATS AND ADJUSTMENTS



6.5 CAST CLEATS AND BASE BELTS, optibelt ALPHA SRP

Shapes and shaping

The cleats of the optibelt ALPHA SRP can be shaped freely and can be designed as described in Subchapter 6.4, Profile "Production of polyurethane cleats". Also here the demoulding capability of the cleat or more precisely, of the cleat sleeve of the outside mould must be considered.

This is only possible, related to the outside shape,

- inwards and
- towards the tool shaft.

Likewise, demoulding related to the cast belt is only possible

- inwards towards the tooth system or belt height and
- lengthwise to the tooth system or crosswise to the belt width.

Furthermore, demoulding is only possible, related to the cast cleat

- downwards towards base belt or cleat height and
- crosswise towards cleat width.

Figures 6.5.3 and 6.5.4 show round and rectangular cleats or cleat belts which can only be demoulded downwards towards the cleat height.

The triangular cleat flush on both sides or the cleat belt in Figure 6.5.5 can also be demoulded towards the cleat width. This casting process basically enables especially thin-walled cleat shapes which can also be of flexible design. Easy to implement, rounded transitions between cleat and belt reduce tension peaks occurring under load.

Figure 6.5.6 shows an L-shaped cleat which can be withdrawn from the outside mould only towards the cleat width. Here, a continuous cleat over the sleeve width is required. After cutting the sleeve, the cleat is arranged flush on both sides to the base belt as the above triangular cleat.

If the downward demoulding capability towards the base belt or cleat height is ensured, vertical holes can be shaped without a subsequent mechanical processing. If inserts are to be placed into the blind holes, they can only be screwed subsequently.

In contrast to the injection-moulded cleats, no glass-fibre reinforcement of the polyurethane is possible in the SRP casting process.

By manufacturing cleats and belts in one cast, cleats with a loosely installed support and the pertaining recess cannot be realised.

With a low rigidity and a high requirement regarding the width tolerance of the cleat, the cutting of the cleats is partly not possible with sufficient precision. Here, in the case of a downward demoulding capability towards the base belt or cleat height, the cleat can be cast narrower than the subsequently cut base belt, as shown in Figure 6.5.4. As a result, not the cleat, but only the base belt is cut during the subsequent cutting open of the sleeve.

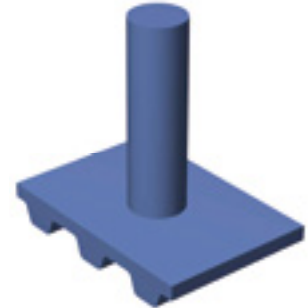

Figure 6.5.3: Cylindrical round cleat: standing cylinder



Figure 6.5.4: Rectangular cleats, arranged in series

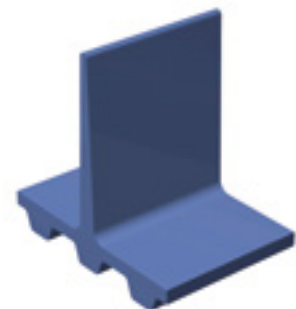

Figure 6.5.5: Triangular cleat with rounded head

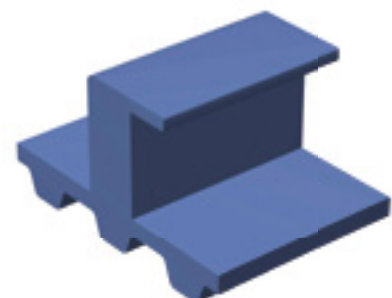

Figure 6.5.6: L-shaped cleat

6 COATINGS, CLEATS AND ADJUSTMENTS



6.5 CAST CLEATS AND BASE BELTS, optibelt ALPHA SRP

As an alternative, undercuts, drill holes and inserts can be subsequently produced and placed in the cleats. These geometric adjustments are possible by applying the methods described in Subchapter 6.6. In Subchapter 6.4, Profile "Dimension tolerances", the different general influential parameters are described. The clamping as a further parameter is likewise described there. For cast cleats, the permanently connected base belt, which should not be bent during clamping, must also be included.

Design guidelines, position and dimension tolerances

For the position and the fastening strength of the cleats on the timing belt, the guidelines of Subchapter 6.4, profile "Position in relation to tooth, number of teeth on pulley and fastening strength" and Table 6.4.4 are to be followed. Only the recess recommended there for cleats of a large width in the cast process, as described above, cannot be produced.

For cleat dimensions up to 5 mm, the dimension tolerances are ± 0.15 mm.
Larger cleat dimensions are available on request.

Cleat design	Dimension tolerance
Cast cleat	± 0.15 mm
Mechanically processed cleat	± 0.5 mm

The position tolerance of cleat to tooth in pitch direction can achieve ± 0.15 mm.

As described in Subchapter 6.4 in subprofile "Position and pitch tolerances", the belt length tolerance must be additionally taken into account in longitudinal direction for the cleat pitch tolerance, see Chapter 7. If restricted cleat pitch tolerances are required, they must be practically determined with the aid of samples and then restricted, if required.

For the position tolerance in width direction, the width tolerance must be included through the slight lateral displacement of the optibelt ALPHA SRP during cutting, see Chapter 7. For the pitches of 5 mm to 10 mm, this is ± 0.5 mm.

Direction	Position tolerance	
Longitudinally or in pitch direction	± 0.15 mm	to the tooth
Crosswise or width direction	± 0.5 mm	for a pitch of 5 mm to 10 mm

6 COATINGS, CLEATS AND ADJUSTMENTS



6.6 ADJUSTMENT THROUGH MECHANICAL PROCESSING

6.6 Adjustment through Mechanical Processing

Subsequent geometric and dimensional adjustments of standard timing belts, coated belts and cleat timing belts extend their application possibilities. The following mechanical processing methods are available:

- Grinding
- Milling
- Water jet cutting
- Punching
- Drilling
- Cutting

Transport drives with mechanically processed belts

The following examples show timing belts, which were adjusted by mechanical processing to the application.

Tube conveyors, geometric adjustment of a coated timing belt

For the tube conveyor in Figure 6.6.1, timing belts with a coating were geometrically adjusted by crosswise milling in such a way that the transport goods are positioned in longitudinal belt direction.

In order to safely fix the parallel conveyed tubes in the recesses, they can be held down by a top pressure belt. The guide rails required in this case are not represented.

If the tubes are taken up in prisms, line contacts occur, which may cause e.g. in the case of thin-walled tubes deformations through the top pressure belt. Here, a groove shape adjusted to the component contour is recommended.

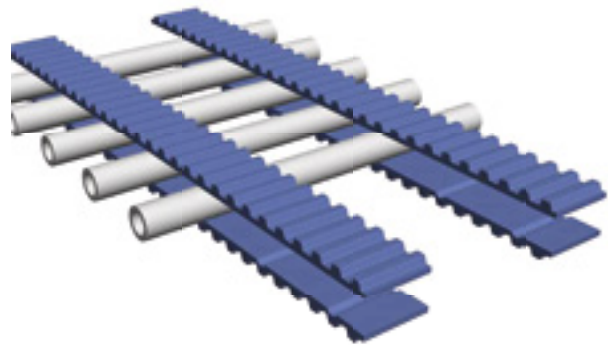

Figure 6.6.1: Transversally grooved parallel conveyor for tubes

Vacuum belts, geometric adjustment of a standard timing belt

For the transport of e.g. unstable components such as foils, the positioning on the belt is enabled by vacuum forces.

Through hole punching and inserted vacuum rails with the accordingly designed ducts, the generated vacuum is transferred to the transport goods. Depending on the design of the vacuum rail, the vacuum belt must be provided with an additional longitudinal groove on the tooth side. Particularly suitable to this end are timing belts without sleeve nose, where vacuum losses can be reduced.

If higher transport forces are to be implemented, the effective vacuum area can be increased by milling in recesses into the coating or the reinforced belt top surface in the area of the hole. To this end, the shape stability of the transport goods has to be taken into account.

The lower side of the timing belt, i.e. the tooth-side groove, which rests on the vacuum rail, can be provided with a polyamide fabric to reduce friction value and wear.

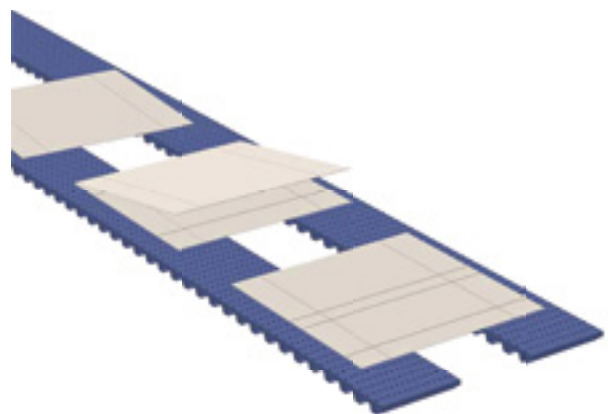

Figure 6.6.2: Vacuum-supported parallel conveyor for paper

6 COATINGS, CLEATS AND ADJUSTMENTS



6.6 ADJUSTMENT THROUGH MECHANICAL PROCESSING

Manufacturing processes

The manufacturing processes described below are used for the processing of standard belts, coatings and cleats on base belts. The selection of the manufacturing process is determined by

- the shape and contour to be achieved,
- the material thickness,
- the processing depth,
- the material,
- the material hardness,
- the tolerances,
- the processing speed
- and the quantity.

Grinding

Height

Re-grinding the coating on the base belt is recommended in the case of increased requirements regarding the total height tolerance. Depending on the coating material, total height tolerances for the coated belt or the cleat belt with flat cleats of up to ± 0.15 mm can be achieved. The process to measure the total height of particularly soft coatings, while grinding is especially suitable as opposed to milling, must be coordinated accordingly, since no standardised measuring process is available for coated belts. Through grinding, the height tolerance of a standard timing belt can be restricted to ± 0.15 mm in order to achieve a more consistent and smoother run in fast operating drives by using backside idlers.

In transport drives, the top surface grinding may cause a slightly roughened coating surface. This leads to a reduced adhesion, e.g. for foil transport, on smooth coatings such as PVC or polyurethane coating foils. Vice versa, the degree of grip is improved with a roughened coating surface and a slightly rough transport goods surface.

Width

For the operation of timing belts, e.g. in vacuum rails, a reduction of the width tolerance is required, which can be limited by grinding to ± 0.15 mm. This also applies to cleat belts, where base belt and shape-stable cleats are ground together to width or for individual shape-stable cleat areas in longitudinal belt direction.

Contours

Top surface contours in coatings, such as e.g. a serrated shape, can be ground on NC machines. As an alternative, special contours in longitudinal and transverse direction can be produced using special grinding discs. By grinding, a comparatively high surface quality is generally achieved.

Milling

In contrast to grinding, milling is only suitable for harder materials; it is not possible to achieve the same surface quality by milling that can be achieved by grinding. In order to position components on transport belts, any contours can be milled in longitudinal or transversal direction in coatings. Figure 6.6.3 shows grooves milled into a coating. The four grooves closed at the sides are also referred to as bags. With these, components can be separated or the vacuum force can be increased by the larger effective area of vacuum belts.

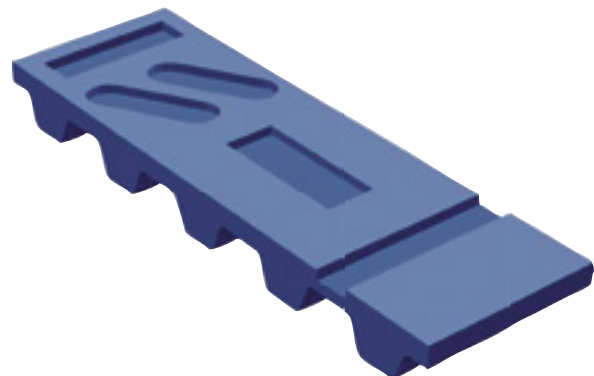

Figure 6.6.3: Milled contours

6 COATINGS, CLEATS AND ADJUSTMENTS

6.6 ADJUSTMENT THROUGH MECHANICAL PROCESSING



Figure 6.6.4 shows a longitudinal groove milled into the tooth systems, which can serve as a guide with an accordingly designed support rail or can accommodate a vacuum rail or can take on a subsequently welded V-guide.

By milling in longitudinal direction, individual belt teeth can be removed to create space for metal teeth to screw on cleats, see Chapter 6.4.

Injection-moulded or cleats cut out of the base plate can be adjusted geometrically prior to the connection with the base belt by milling. Also rigid cleats already connected to the base belt can basically be processed by milling.

The dimension tolerance for milling polyurethane base belts and coatings with hardnesses larger than / equal to 85 Shore A amounts to up to ± 0.15 mm. The accuracy decreases in materials with lower hardness values and a lower rigidity and must be verified in tests, if required.

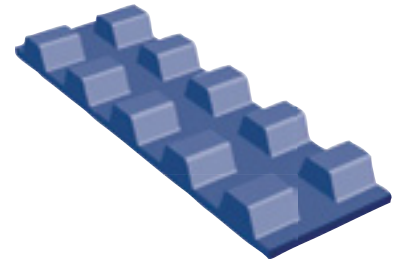

Figure 6.6.4: Longitudinal groove in tooth system

Water jet cutting

In the water jet cutting process, a jet of water and sand of a diameter of 0.8 mm cuts through the component to be processed. In contrast to cutting, material is removed in this process.

With the aid of water jet cutting, any precise hole contours can be produced in belts and cleats without any additional tool costs. The minimum possible radius of a hole or a corner in a hole or inside contour is 0.4 mm. In contrast outside contours or corners of a cleat can be cut to that without a radius through water jet cutting. The cutting surfaces are always parallel to each other. For more complex contours, production costs for a NC programme and tool holders may accrue once.

Also steel tensile reinforcements are cut in the polyurethane belt smoothly and without frizzling. Since through water jet cutting, as opposed to punching, no irregular deformations on steel tensile reinforcements occur, it is possible to produce precisely round holes. As a result, the mounting of screws is facilitated and the positioning accuracy of the component carrier to be fastened is increased.

Punching

Figure 6.6.5 shows a belt punched in the web area for a vacuum application. The punching of the inside contours of a belt can be performed on smaller belt profiles with thin steel tensile reinforcements.

By using multiple tools, contours arranged closely next to each other can be produced in a time-saving and economic manner in one work step. For these contours, the corresponding tool costs accrue.

During a punching operation, the compound structure of steel tensile reinforcement and polyurethane may move sideways. After punching, these areas go back to their original positions. The punched contour changes only slightly due to this. When punching a round hole, often a slightly oval hole is produced. For vacuum belts, this slight contour deviation is insignificant. When fastening metal cleats, however, cylindrical holes are preferred for easy installation and precise guiding. Furthermore, the tensile reinforcements may frazzle at the cutting points and protrude into the punched contour. Sensitive transport goods may then be damaged by steel cord strands. To avoid this, timing belts with aramid tensile reinforcements or tension cord free zones are preferably employed.

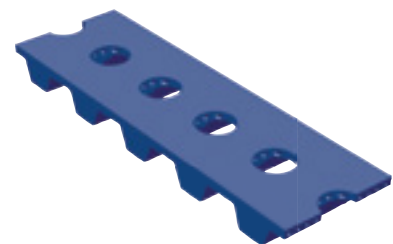

Figure 6.6.5: Punched timing belt

6 COATINGS, CLEATS AND ADJUSTMENTS



6.6 ADJUSTMENT THROUGH MECHANICAL PROCESSING

Drilling

Continuous drill holes in polyurethane belts with aramid cord or in rubber belts with glass fibre tension cord or in a tension cord free zone can be produced using special drills. The only costs accruing here are set-up costs.

The following standard drill hole diameters [mm] for belts with coating, if applicable, are recommended:

2	2.5	3	3,5	4	4,5	5	5.5	6	8	10	12
---	-----	---	-----	---	-----	---	-----	---	---	----	----

The diameter tolerance for drilling is up to ± 0.20 mm for polyurethane base belts and coatings with hardnesses larger than/equal to 85 Shore A. The accuracy decreases in materials with a smaller hardness and lower rigidity and must be verified in tests. These statements likewise apply to drill holes in polyurethane cleats.

For low quantities cleats of polyurethane with hardnesses higher than 90 Shore A can be provided with through holes or blind holes by drilling. To this end, the cleat should have a high rigidity and large clamping areas to be able to set a sufficient resistance to drilling and clamping forces. For cleats with lower hardnesses, the milling process is recommended with lower quantities.

The following standard drill hole diameters [mm] for cleats are recommended:

2	2.1	2.2	2.3	...	9.7	9.8	9.9	10	11	12	13
---	-----	-----	-----	-----	-----	-----	-----	----	----	----	----

Cutting

With an increasing coating thickness, the flexibility of coated belts decreases and the required minimum timing belt pulley diameter – for formula see Subchapter 6.2 – increases to prevent a cracking of the coating or the joint.

If the timing belt pulley diameter must be kept relatively small despite a top surface installation, the coating can be cut transversally opposite the tooth gap. As shown in Figure 6.6.6, the coating in the diversion opens and the flexibility is significantly increased. In the straight line, the coating is closed so that the transport is not affected.

Compact coatings can be milled into, which means that due to the removal of material no closed coating surface is produced.

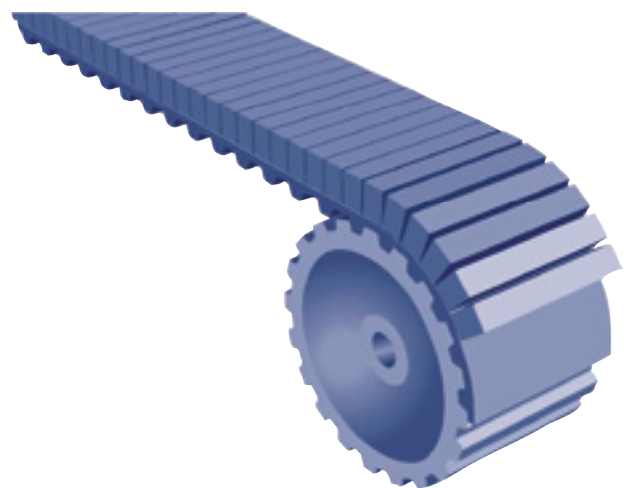

Figure 6.6.6: Coating with cut

7 DESIGN AIDS, DIMENSIONS, TOLERANCES



7.1 BELT TENSION: MEASURING METHODS AND ADJUSTMENT

7.1 Belt Tension: Measuring Methods and Adjustment

The correct adjustment of the belt tension or the static belt tension is significant for

- a safe functioning, reliable operation with fewer downtimes,
- achieving a high efficiency,
- the maximum possible lifetime of belt and pulleys.

This means in summary

- minimum costs during operation, for maintenance and spare parts requirement.

The thumb pressure method is only suitable for a first rough pre-adjustment of the static belt tension. Without an adjustment with the aid of measuring instruments, the adjustment might lead to

- a belt tension that is too low

or a

- belt tension that is too high

which will then lead to unnecessary and expensive early failures of the drive.

A belt tension that is too low may e.g. cause an increased tooth load and an early shearing off of the teeth from the belt. In addition, the risk of skipping and hence very high loads on shafts and bearings increases.

A belt tension that is too high can e.g. lead to excessive running noise, strong tooth wear, increased pulley wear, early cord fatigue and increased side forces on the flanges.

In both cases, damage may occur to the bearings and shafts in addition to belts and pulleys. Further details about early failures caused by deviating belt tensions are indicated in the Subchapter 7.8 "Damage Patterns, Causes and Action".

Conditions and instructions

For a correct adjustment of the belt tension, the timing belt should be unloaded and freely movable, if possible.

In power drives, the driving pulley and the driven pulley should be freely movable. In multi-shaft drives, all pulleys should be freely movable.

For linear and transport drives, the driving pulley and the linear slide or the tight side on the guide rail should be freely movable, i.e. free of any masses to be moved.

By moving the belt back and forth, the belt tension can be distributed equally in an unobstructed way to all span sides. Newly installed belts start additionally, to settle in the pulleys. Two belt circulations are ideal, which not be possible for linear drives or can be very time-consuming with large shaft spacings. As an alternative and in a simplified way, the pulleys of the belt drive can be turned back and forth several times, i.e. at least three times.

For large drive units with a high speed ratio $i \neq 1$, this refers to the largest pulley in the belt drive.

If free movement is not possible, no more than one pulley may be blocked in all drives. In linear drives, the slide and in transport drives the transport side must be freely moveable.

If the sides of a drive are tensioned through stationary pulleys or masses in linear drives, in exceptional cases it may be possible to adjust the span forces which can be determined in a frequency measurement around the calculated specified value. In Chapter 4, an example of this is represented where a downward force acts with a blocked driving pulley so that the span sides of the linear drive are tensioned in a standstill. For a transport drive, this possibility of averaging is not available, if the mass is distributed on the transport side.

7 DESIGN AIDS, DIMENSIONS, TOLERANCES



7.1 BELT TENSION: MEASURING METHODS AND ADJUSTMENT

Table 7.1.1: Adjustment and measurement of the specified static belt tension

Power drives		Linear drives		Transport drives	
Drive motor	Output machine	Drive motor	Linear slide	Drive motor	Goods conveyed
Free rotary movement	Free rotary movement	Free rotary movement	Free movement	Free rotary movement	Free movement
$M_{input} = 0 \text{ Nm}$	$M_{output} = 0 \text{ Nm}$	$M_{input} = 0 \text{ Nm}$	$m = 0 \text{ kg}$	$M_{input} = 0 \text{ Nm}$	$m = 0 \text{ kg}$
Safety advice: Prior to the beginning of installation and maintenance activities, drive and output must be secured against unintended movement. In addition, the relevant instructions given by the machine manufacturer must be observed.					
Determination of the specified value of the static belt tension F_T and the pertaining frequency f , see Table 7.1.3 or the corresponding elongations x_V , x_{VCP} or ΔL_V , see Table 7.1.4					
Static belt tension F_T		Adjustment	Moving	Measuring	
$F_T F_T F_T$	$F_T > 0 \text{ N}$	Setting of a low static belt tension F_T without instrument support per thumb pressure method			
		Movement: Checking of the free movability of belt and pulleys: Circumferential force $F_U = 0 \text{ N}$			
$F_T F_T F_T$	$F_T \approx \text{specified value}$	Adjustment of the increased static belt tension F_T without measuring instrument according to the thumb pressure method			
		Movement: 3 x turning the (large) pulley back and forth by pulling a span side			
$F_T F_T F_T$	$F_T = \text{specified value}$	Measuring and correction of the existing static belt tension F_T with measuring instrument			
		Adjustment of the specified static belt tension F_T if required again through moving (3 x turning), measuring and correcting			
<p>$F_U = 0 \text{ N}$</p>		<p>$F_U = 0 \text{ N}$</p>		<p>$F_U = 0 \text{ N}$</p>	

7 DESIGN AIDS, DIMENSIONS, TOLERANCES



7.1 BELT TENSION: MEASURING METHODS AND ADJUSTMENT

Measuring methods, applications and measuring instruments

For the correct adjustment of the belt tension of a timing belt, the comparatively precise frequency measurement should be performed for freely oscillating span sides; to do so, a frequency measuring instrument such as from the optibelt TT series is required.

For the clearly less accurate measurement of the elongation during the tensioning of long belts with span lengths over 1000 mm only a measuring tape, e.g. from the optibelt SERVICE-BOX, is required.

Table 7.1.2: Simplified assignment and characteristics of the belt tension measurement

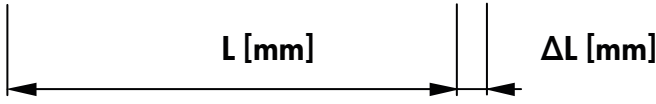
Measurement of the belt tension, accuracies, measuring instruments		
Power drives	Linear drives	Transport drives
or small linear, transport drives	or large power drives, e. g. with long optibelt ALPHA FLEX	
Belt span length L, freely oscillating	Belt span length L ≥ 1000 mm	
Frequency measurement	Measurement of elongation	
 f [Hz]		
High accuracy of measurement	Low to medium measuring accuracy depending on belt length	
High repetition accuracy	An already tensioned drive cannot be checked	
Frequency measuring instruments from the optibelt TT series	Measuring tape from the optibelt SERVICE-BOX, calliper, if required	
High quality, higher purchasing costs by comparison	Simple, inexpensive	

Belt tension adjustment through frequency measurement

For the frequency measurement, a well accessible, at least slightly tensioned belt span side between the pulleys is brought into vibration with the finger in the same way as a guitar string. In the case of linear drives, alternatively also one of the span lengths between pulley and slide can be brought to vibrate. The selected span side must be able to oscillate freely without e.g. touching a housing. The natural frequency f of the span side depends on the meter weight m_k and the free span length L, see e.g. Figure 2.1.1, a dimension for the static belt tension F_T , see Table 7.1.1. For the measurement, the frequency measuring instruments from the optibelt TT series are suitable.

$$f = \sqrt{\frac{F_T \cdot 10^6}{4 \cdot m_k \cdot L^2}} \quad [\text{Hz}] \quad \text{with } F_T [\text{N}], m_k \left[\frac{\text{kg}}{\text{m}} \right] \text{ or } \left[\frac{\text{g}}{\text{mm}} \right], L [\text{mm}]$$

7 DESIGN AIDS, DIMENSIONS, TOLERANCES



7.1 BELT TENSION: MEASURING METHODS AND ADJUSTMENT

If the purchase of a frequency measuring instrument from the optibelt TT range is planned, the values specified for frequency f should be determined for all drives to be tested and all freely oscillating span sides selected. The examples mentioned and other cases that could prevent frequency measurements from being made are listed in the following section.

The frequency measurement can always be performed for linear or multi-pulley drives on any span sides. This also applies to span sides which are the result of e.g. an internal timing belt pulley and an external cylindrical idler or, in the case of double profile belts, an external timing belt pulley.

Table 7.1.3: Belt tension adjustment through frequency measurement

Belt tension adjustment through frequency measurement		
Steps to adjust the static belt tension of the timing belt The timing belt is installed on aligned pulleys. The alignment can be performed e.g. by the optibelt LASER POINTER. The required specified values for the frequency f must have been determined in advance.		
Power drives	Linear drives	Transport drives
Tensioning of the mounted belt and hence all free, unloaded span sides		
Measurement and adjustment to the specified value f and the associated static span length F_T		

The metre weight m_k is indicated in the respective Technical Data Sheet for the widths indicated there. For other widths which are indicated there which deviate clearly more than the respective width tolerance, the metre weight can be inter- or extrapolated. If the metre weight is unknown and the belt is known, the metre weight can also be determined by weighing the belt mass m and dividing by the belt length L_w .

$$m_k = \frac{m}{L_w} \quad \left[\frac{\text{kg}}{\text{m}} \right] \text{ or } \left[\frac{\text{g}}{\text{mm}} \right] \quad \text{with } m \text{ [kg], } L_w \text{ [m] or } m \text{ [g], } L_w \text{ [mm]}$$

Small deviations between theory and practice can be tolerated and are partly a result of the fact that the belt mass and hence the meter weight m_k may vary slightly by width and height tolerances.

7 DESIGN AIDS, DIMENSIONS, TOLERANCES



7.1 BELT TENSION: MEASURING METHODS AND ADJUSTMENT

Belt tension adjustment through measurement of the elongation

The belt tension adjustment through measurement of the elongation does generally not achieve the accuracy of the belt tension adjustment through the measurement of the natural frequency of a freely oscillating span side. The measurement presented here through the elongation is suitable, if the measurement of the frequency f on at least one of the span sides of the drive cannot be taken.

This is the case, if

- accessible and freely oscillating span sides are outside the measuring range of the selected frequency measuring instrument, e.g.: $10 \text{ Hz} \leq f \leq 300 \text{ Hz}$,
- no suitable span side is accessible,
- the span sides cannot oscillate freely through housings or strongly dampening coatings,
- the metre weight cannot be determined,
- cleats are attached,
- no measuring instrument is available from the optibelt TT series for the frequency measuring range $1 \text{ Hz} \leq f \leq 600 \text{ Hz}$.

To measure the actual elongation, only a calliper or a tape measure, e.g. from the optibelt SERVICE-BOX, and a pen to mark a defined length on the belt and any relevant elongation are required.

The adjustment of the static belt tension F_T can be performed from the currently unloaded condition through a defined elastic elongation of the timing belt. The static belt tension F_T can therefore not be measured and determined directly and simply on an already tensioned belt drive, see Table 7.1.2.

The following designs are related to Table 7.1.4. The required elastic elongation and the pertaining static belt tension F_T are reached for a belt tension length x_V of a shaft, which can be derived depending on the length L of the tensioned span side or the tensioned span sides and the then existing spring rigidity. The longer the span side to be tensioned, the larger the belt tension length x_V , and the more precise can the intended static belt tension be adjusted. The span length L , which has to be tensioned, should be longer than 1000 mm, if possible, since the belt tension length x_V then is up to 1 mm or up to 2 mm and more, depending on the product group, to ensure that it can be adjusted at the required accuracy.

The measurement of the tension length x_V is taken on the adjustable, just unloaded shaft; the free span lengths L in the case of a two-pulley drive with the speed ratio $i = 1$ corresponding to the drive centre distance a , and the adjustment occurring in the straight extension of the connecting line between the shafts.

As an alternative to the measurement of the required tension length, x_V the spring length ΔL_V can also be measured and read during belt tensioning at every other position of the belt. For this, only an associated base length L_V must have been marked on the belt in an unloaded condition. This base length L_V can be marked on a tight side, but can also go around a pulley or two and more internal pulleys to achieve a length larger than 1000 mm, if possible.

7 DESIGN AIDS, DIMENSIONS, TOLERANCES



7.1 BELT TENSION: MEASURING METHODS AND ADJUSTMENT

Table 7.1.4: Belt tension adjustment through measurement of the elongation

Belt tension adjustment through measurement of the elongation		
Steps to adjust the static belt tension of the timing belt The timing belt is installed on aligned pulleys. Alignment e.g. by optibelt LASER POINTER. The required specifications for tensioning length x_V or frequency f were determined, see Chapter 3, 4 and 5.		
Power drives	Linear drives	Transport drives
Marking with not or almost not tensioned belt, $F_T = 0 \text{ N}$:		
– Position of the adjustable shaft (span length L or drive centre distance $a \geq 1000 \text{ mm}$), see at x or		
– for linear drives position of the optibelt CP clamping plate on allowance x_{CP} or		
– selected base length L_V ($L_V \geq 1000 \text{ mm}$), if required, already before the installation in a straight, unrolled condition		
Tensioning and adjustment of the mounted belt and the selected span side to the specified value of the static span force F_T		
– on the tension length x_V of the shaft or		
– for linear drives alternatively also on the tension length x_{VCP} of the optibelt CP clamping plate or		
– on the elongation ΔL_V of the marked base length L_V		

7 DESIGN AIDS, DIMENSIONS, TOLERANCES

7.2 SHAFT/HUB CONNECTIONS



7.2 Shaft/Hub Connections

The following shaft/hub connections are mainly used:

- Clamping bushings, primarily force-fit
- Finished bore with groove, form-fit

For the clamping bushings, a distinction is made between

- optibelt TB taper bushing and
- optibelt CE clamping bushing.

Although for clamping bushings additional costs accrue for their purchase, the shaft/hub connection using a taper bushing is particularly economic, since an axial protection is directly possible without any further structural measures. For the taper bushing system, an additional processing of the hub is not necessary with the pertaining optibelt ZRS timing belt pulley. This also applies to the replacement requirement, when the basically undamaged taper bushing can be replaced.

In contrast to this, a finished bore is required for the use of a CE clamping bushing. For the form-fit shaft/hub connection type finished bore with groove, a groove must be produced in the hub in addition to the required finished bore.

For any known shaft diameter the appropriate bore diameter of the optibelt taper bushing can be assigned.

On pulleys for finished bore, a CE clamping element can be used as a shaft/hub connection, which enables a quieter run compared to the taper bushing system. Similar to the taper bushing system, the shaft diameter and additionally the maximum possible bore diameter of the pulley hub must be aligned here with the selected CE clamping bushing. In addition, the bore diameter of the pulley and the outside diameter of the CE clamping bushing must be assigned. The standard product range list for pulleys for a cylindrical hole shows the diameter of the preliminary hole and the maximum possible diameter of the finished bore.

Under a strong impact load and a continuous rotation change during operation, no shaft/hub connection should be used with a feather key from medium heavy drives, as the feather key groove might deflect. This particularly applies to aluminium timing belt pulleys. Particularly under the above conditions, a shaft/hub connection should be used per taper bushing – standard in cast or steel pulleys – with additionally protecting feather key or a CE clamping bushing.

All the required technical data about optibelt TB taper bushings and CE clamping bushings can be found in the Optibelt product range list. In order to prevent damage to the clamping bushings and produce a durable function-reliable shaft/hub connection to transfer the torques particular attention must be made to the tightening torques of the screws. In addition, the imperial threaded pins of socket head screws are shown with the taper bushings; and the metric socket head screws or hexagonal bolts are listed with the CE clamping bushings, where present.

Table 7.2.1: Profiles and characteristics of standard timing belt pulleys and shafts

Material	Timing pulley profile	Timing shaft profile	Pre-bore ³	Taper bushing ³
Grey cast iron, steel	XL ¹ L H XH 5M 8M 14M	XL ¹ L	●	● except for XL
Aluminium	XL ¹ T2.5 ² T5 T10 AT5 AT10	XL ¹ T5 T10	●	

¹ Material depends on diameter

² Small diameters not pre-bored

³ Pre-boring or taper bushing not for timing shafts

7 DESIGN AIDS, DIMENSIONS, TOLERANCES

7.3 DESIGN AIDS



7.3 Design Aids

Timing belt pulleys

The profiles of the timing belt pulleys are standardised as the pertaining timing belt profiles, or are manufactured to a particular standard. The profiles and the referenced standards are listed in Subchapter 1.4 and Table 1.4.9. In general, standard and special timing belt pulleys are differentiated.

The use of optibelt ZRS timing belt pulleys from the standard product range minimises costs and delivery times. All standard timing belt pulleys of aluminium, steel and grey cast iron are pre-bored and intended for the shaft/hub connection finished bore with groove or without groove for CE clamping bushings. These standard timing belt pulleys can be provided with a finished bore and groove on request. Standard timing belt pulleys for the taper bushing system are basically only manufactured from steel or grey cast iron.

The Optibelt product range list includes the corresponding designs, drawings and dimensions of the standard timing belt pulleys. In addition, CAD drawings are made available for standard timing belt pulleys in the common file formats. These are available on the Internet at www.optibelt.com.

Should the application of standard pulleys not be possible for design reasons or due to ambient conditions, special pulleys can be supplied according to drawings or descriptions. Standard pulleys with subsequently produced finished bore with the tolerance field e.g. H7 and groove, e.g. as per DIN 6885 Part 1 are likewise considered special pulleys.

As shown in Table 7.2.1, standard timing belt pulleys are manufactured with the profiles T and AT of aluminium. Compared to steel and cast pulleys, aluminium pulleys exhibit a reduced moment of mass inertia, which has a particularly positive effect in linear drives for continuous acceleration and braking. The higher wear of aluminium compared to steel or grey cast iron can be significantly reduced, if required, e.g. by

- rotationally highly loaded drives, mostly power drives, or
- specifically highly loaded drives with PU timing belts with polyamide fabric PAZ on the tooth side, or by hardcoating an aluminium special pulley.

The optibelt ZRS timing belt pulleys are static, irrespective of their size and design, i.e. balanced on one level according to balance quality G6.3. Timing belt pulleys processed on all sides always reach or underrun this balance quality according to DIN/ISO 1940 and are therefore not subjected to a separate balancing.

Timing belt pulleys running at velocities $v \geq 30$ m/s or up to the maximum permissible belt velocity and timing belt pulleys in drives, which are to reach an above-average quiet run, e.g. also at lower velocities than $v = 30$ m/s should additionally be balanced in two levels, i.e. dynamically according to balance quality G6.3 or finer.

Timing belt pulley tolerances

Parallelism

The teeth must be in parallel to the centre of the bore with a deviation of maximum 0.001 mm per millimetre of width. For imperial profiles, the following applies: 0.01 mm per 10 millimetres of width.

Conicity

The conicity must not be higher than 0.001 mm per millimetre of the head width and must not exceed the permissible outside diameter tolerance according to Table 7.3.3. For imperial profiles, the following applies: 0.01 mm per 10 millimetres of head width.

Surface finish

The surface quality must not exceed the value $R_a = 3.2 \mu\text{m}$ as per ISO/R 468 on tooth flanks and heads.

7 DESIGN AIDS, DIMENSIONS, TOLERANCES



7.3 DESIGN AIDS

Table 7.3.1: Axial run-out tolerances

Outside diameter d_a [mm]		Maximum total variation [mm]	
Imperial pitch	Metric pitch	MXL, XL, L, H, XH, 5M, 8M, 14M	T2.5, T5, T10, T20, AT5, AT10, AT20
≤ 101.60	≤ 100	0.1	0.1
> 101.60 ≤ 254.00	> 100 ≤ 250	0.001 per 1 mm outside diameter (not 5M, 8M, 14M)	0.01 mm per 10 mm outside diameter (also 5M, 8M, 14M)
> 254.00	> 250	0.25 mm and additionally 0.0005 mm per 1 mm outside diameter	0.25 mm and additionally 0.005 mm per 10 mm outside diameter

Table 7.3.2: Radial run-out tolerances

Outside diameter d_a [mm]		Maximum total variation [mm]	
Imperial pitch	Metric pitch	MXL, XL, L, H, XH, 5M, 8M, 14M	T2.5, T5, T10, T20, AT5, AT10, AT20
≤ 101.60	≤ 100	0.1	0.1
> 101.60 ≤ 254.00	> 100 ≤ 250	0.001 per 1 mm outside diameter (not 5M, 8M, 14M)	0.01 mm per 10 mm outside diameter (also 5M, 8M, 14M)
> 254.00	> 250	0.25 mm and additionally 0.0005 mm per 1 mm outside diameter	0.25 mm and additionally 0.005 mm per 10 mm outside diameter

Table 7.3.3: Limit dimensions of the outside diameters

Outside diameter d_a [mm]		Permissible deviation from outside diameter d_a [mm]	
Imperial pitch	Metric pitch	MXL, XL, L, H, XH, 5M, 8M, 14M	T2.5, T5, T10, T20, AT5, AT10, AT20
≤ 25.40	≤ 25	+0.05 0	+0 -0.05
$> 25.40 \leq 50.80$	$> 25 \leq 50$	+0.08 0	+0 -0.05
$> 50.80 \leq 101.60$	$> 50 \leq 100$	+0.10 0	+0 -0.08
$> 101.60 \leq 177.80$	$> 100 \leq 175$	+0.13 0	+0 -0.08
$> 177.80 \leq 304.80$	$> 175 \leq 300$	+0.15 0	+0 -0.10
$> 304.80 \leq 508.00$	$> 300 \leq 500$	+0.18 0	+0 -0.10
> 508.00	> 500	+0.20 0	+0 -0.15

Minimum diameter

The minimum timing belt pulley diameter of the standard timing belt pulleys are shown in the Optibelt price and product range lists.

The minimum pulley diameter of the respective belt profile and the pertaining cord should not be undercut, if possible, as otherwise the lifetime of the timing belt might be reduced.

The values indicated in Table 7.3.4 of the most important profiles for polyurethane timing belts with steel cord are only for basic orientation. Minimum timing belt pulley diameters, minimum diameters of cylindrical idlers arranged on the tooth side and top surface and minimum clamping lengths of the selected belt profile are indicated in the respective up-to-date Technical Data Sheet. This especially applies to possible design variations, which are generally presented in Chapter 1 and used in Chapters 3, 4 and 5.

Table 7.3.4: Minimum diameters and clamping lengths

Profile	Minimum number of teeth of the timing belt pulley z_k	Minimum effective diameter of the timing belt pulley d_w [mm]	Minimum diameter of outside idler [mm]	Minimum clamping length for fastening by clamping plate [teeth]
MXL	10	6.47	15	—
XL	10	16.17	30	8
L	12	36.38	45	6
H	14	56.60	65	6
XH	18	127.34	120	6
T2.5	10	7.96	15	—
T5	10	15.92	30	8
T10	12	38.20	60	6
T20	15	95.49	120	6
AT5	15	23.87	60	6
AT10	15	47.75	100	6
AT20	18	114.59	180	6
5M	15	23.87	60	6
8M	18	45.84	100	6
14M	25	111.41	180	6

7 DESIGN AIDS, DIMENSIONS, TOLERANCES



7.3 DESIGN AIDS

Idlers

Idlers do not transmit power within the drive. Linear drives and transport drives are equipped with a guide idler as a second pulley. This guide idler is usually a timing belt pulley. All idlers running on the tooth side can also be designed as cylindrical flat pulleys, depending on the design. Idlers running on the top surface are always of a cylindrical shape.

Idlers are differentiated depending on their function with regards to guide, tension, supporting and inside idlers. Guide and tension idlers may operate in a double function.

Additional idlers should be avoided due to the increasing alternating bending load on the belt and for cost reasons. If an additional idler is required and if there is a selection possibility for the arrangement, the idler should always be arranged

- on the less loaded span side and
- inside

to minimise additional loading.

To this end, care should be taken with the minimum diameters of the idlers as with the pulleys. The minimum pulley diameters for timing belt pulleys and cylindrical idlers are indicated in the Technical Data Sheets. Minimum pulley diameters should be avoided if high lifetimes are expected. The distance between an idler and a pulley arranged close to it should be sufficiently high to enable an unconstrained installation of the timing belt and to minimise the influence of deviations from the alignment of the shafts and pulleys which is unavoidable in practice.

Guide idlers

Additional guide idlers are used to enlarge the contact at single pulleys, which is possibly too small. By an accordingly increased number of engaging teeth, the power transmission is enabled at all or increased so that the required width of the drive can be reduced.

In addition, guide idlers can guide the belt span side around obstructions which are possibly present.

Tension idlers

An additional tension idler can be used for drives with a firm drive centre distance in order to adjust the correct static belt tension. This is a prerequisite for high function reliability and maximum power transmission. In addition, an unconstrained fitting of the timing belt is possible.

For an inside arrangement of the tension idler, see Figure 7.3.1, and a comparatively low number of teeth on the small pulley, the tension idler should be arranged as far as possible from the small pulley in order to reduce the contact to the lowest possible extent. Here the following applies for simplification, with a_1 being the drive centre distance between the small pulley and the tension idler:

$$a_1 > \frac{2 \cdot a}{3} \quad [\text{mm}] \quad \text{with } a \text{ [mm]}$$

For an outside arrangement of the tension idler, see Figure 7.3.2, this should be arranged as close as possible to the small pulley in order to increase the contact and the number of engaging teeth. The following applies by simplification:

$$a_1 < \frac{a}{3} \quad [\text{mm}] \quad \text{with } a \text{ [mm]}$$

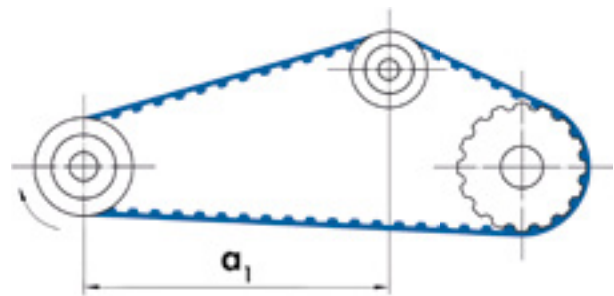

Figure 7.3.1: Arrangement of the inside tension idler

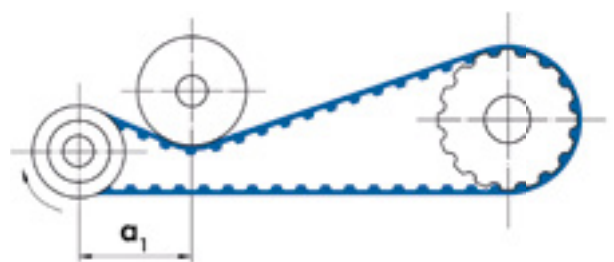

Figure 7.3.2: Arrangement of the outside tension idler

7 DESIGN AIDS, DIMENSIONS, TOLERANCES



7.3 DESIGN AIDS

Inside idler, drive centre distance recommendation

Inside idlers are recommended for a strongly oscillating belt span side. Strong span side vibrations increasingly occur in power drives with a continuous impact load. This applies particularly, if in comparison to the two timing belt pulley diameters d_w , a large drive centre distance a is present. As the drive centre distance of a machine is usually roughly specified, the following drive centre distance recommendation can also be called a diameter recommendation.

$$a < 2 \cdot (d_{wk} + d_{wg}) \text{ [mm]} \quad \text{with } d_w \text{ [mm]}$$

Based on experience, there is a greater probability that considerable span side vibrations will occur with an increasing drive centre distance in relation to the pulley diameter. This usually applies only to the relieved span side. If required, inside idlers should only slightly deflect the span side to be smoothed if possible, and should not be arranged centrally towards the span side.

Supporting idler

Supporting idlers can be used as an alternative to support rails in both span sides e.g. of a transport drive and to reduce friction loss and wear. Cylindrical supporting idlers on the tooth side should not directly run on the tooth system, but on smooth, subsequently produced wedges or longitudinal grooves of an optibelt ALPHA SPECIAL timing belt. For longitudinal grooves, the influence of the sleeve nose on the smooth running behaviour must be taken into account, which can be closed using a welded-on foil.

In contrast to the general recommendation, supporting idlers can be designed with a spring load to compensate height changes of the transport belt by wear and height variations of the transport goods in transport drives.

Flanges, lateral guide

The timing belt must be protected against off-track running from the timing belt pulleys. This is possible for standard drives e.g. by

- flanges on pulleys,
- support rails with lateral flanks or
- clamping plates at the slide of a small linear unit.

Furthermore,

- track timing belts with V-guide and V-shaped grooved pulleys and support rails,
- optibelt ALPHA SPECIAL timing belts grooved on the tooth side and support rails designed according to the groove shape

can be used mostly for transport tasks in special drives.

The above representation in Figure 7.3.3 shows a drive with two timing belt pulleys where one timing belt pulley is equipped with flanges. If

$$a \leq 8 \cdot d_{wk} \text{ [mm]} \quad \text{with } d_w \text{ [mm]},$$

one timing belt pulley with flanges on both sides is sufficient for standard drives with two pulleys to ensure the safe guidance of the timing belt pulley.

For standard pulleys from the Optibelt product range and price lists, the small and medium diameters are equipped on both sides with flanges. In contrast, the large pulley diameters, which can be used to realise, in combination with the smaller pulley diameters, accordingly large speed ratios $\neq 1$, are designed without flanges.

7 DESIGN AIDS, DIMENSIONS, TOLERANCES



7.3 DESIGN AIDS

The above formula is a simplified recommendation. This applies to a smoothly running drive, a stable housing structure and carefully aligned shafts and pulleys.

If additional cylindrical idlers are present and equipped with flanges, depending on the arrangement and geometry of the drive, extra flanges are not necessary on one or more timing belt pulleys.

As an alternative to the arrangement of flanges on only one pulley or idler, they can also be attached alternately on timing belt pulleys or idlers, see Figure 7.3.3, centre sketch.

For a large drive centre distance in proportion to the diameter d_{wk} of the small pulley, the timing belt pulleys should be designed with flanges on both sides. Figure 7.3.3 shows a drive with two pulleys with flanges on both sides in the lower sketch.

An arrangement of a flange on the same side of a pulley, viewed axially, is possible with special designs of the optibelt ALPHA FLEX timing belts.

To improve the running in and out of the side areas of the timing belt along the flanges, they are crimped 8° to 25° or equipped with a chamfer in the case of very small diameters. In both cases, the edges must be bevelled. Due to this design, a kink in the timing belt is prevented with a correct alignment of pulleys and idlers. For large diameters and profiles, the flanges are not attached by pressing due to an increased load of the lateral forces, but screwed on to the timing belt pulley.

The distance of flanges of a standard timing belt pulley is also selected such that the timing belt pulley can be mounted in an unconstrained way when the positive width tolerance is reached and a sufficient side clearance is available. Further details can be found in the standards for timing belt pulleys, which are referenced in Subchapter 1.4, Table 1.4.8.

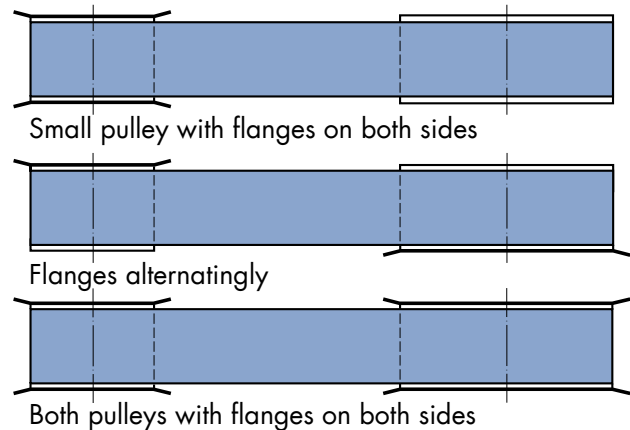

Figure 7.3.3: Arrangement of the flanges on a two-pulley drive

Clamping plates

The optibelt CP clamping plates, see Figure 7.3.4, are equipped with eight profile-dependent tooth gaps to accommodate the teeth of the optibelt ALPHA LINEAR timing belt. Further information e.g. about the dimensions are included in the Optibelt product range list. The timing belt ends are fastened on the top surface e.g. to a tool slide using one clamping plate each, see schematic representation of Figure 4.2.1. The schematic representation of a linear drive with movable motor is shown in Figure 4.2.2.

The clamping length per belt end is dimensioned with the optibelt CP clamping plate in such a way that the permissible tensile force can be transmitted. The minimum number of teeth $z_{cp \min}$ of the timing belt engaged in the clamping plate can be found in Table 7.3.4 or more precisely in the up-to-date Technical Data Sheet. Falling further below this number requires a verification in a test. The clamping plate should be parallel to the free side of the timing belt in order to avoid a kink in the timing belt at the transition between span side and clamping.

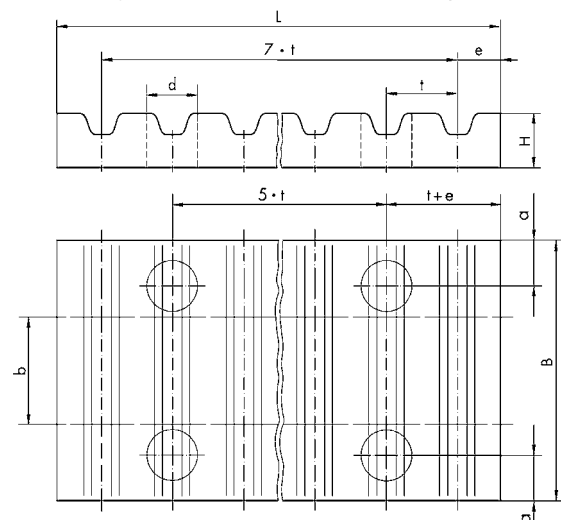

Figure 7.3.4: Clamping plate, parameter dimensions

7 DESIGN AIDS, DIMENSIONS, TOLERANCES



7.4 BELT TOLERANCES

7.4 Belt Tolerances

The belt tolerances and the length measurement conditions are defined in the timing belt conditions, which are listed in Subchapter 1.4 and Table 1.4.9.

Length measurement conditions

The following length measuring method is related to endless optibelt ALPHA TORQUE/POWER and ALPHA FLEX timing belts. The timing belt is laid over two measuring pulleys of the corresponding profile, which have the same size and can be rotated. One pulley is supported on a non-movable shaft, whereas the other is mounted on a parallel adjustable shaft to vary the drive centre distance.

The movable measuring pulley is loaded with the measuring force as shown in Figure 7.4.1. The permissible tolerances of the measuring pulleys as well as the values of the measuring force can be found in the Tables 7.4.1 and 7.4.2. Prior to the measurement of the drive centre distance a , the loaded belt should travel at least two revolutions over the measuring pulleys to enable the placing in the pulleys. The permissible length tolerance a_{Ltol} in Table 7.4.3 refers to the drive centre distance and is therefore only half as big as the limit dimension of the effective length. The effective length can be derived from the following equation:

$$L_w = 2 \cdot a + U_w \quad U_w \text{ of Table 7.4.1}$$

Table 7.4.1: Measuring pulleys to determine the belt length

Profile	Number of teeth z	Effective circumference U_w [mm]	Outside \varnothing	Radial run-out tolerance of outside \varnothing [mm]	Axial run-out tolerance [mm]
MXL	20	40.64	12.428 ± 0.013	0.013	0.025
XL	10	50.80	15.662 ± 0.013	0.013	0.025
L	16	152.40	47.748 ± 0.013	0.013	0.025
T2.5	20	50.00	15.400	0.013	0.025
T5, AT5	20	100.00	31.000	0.013	0.025
T10, AT10	20	200.00	61.800	0.013	0.025
T20, AT20	20	400.00	124.500	0.013	0.050

Table 7.4.2: Measuring forces to determine the belt length

Standard belt width b_{S1} [mm]	Measuring forces [N]									
	MXL	XL	L	T2.5	T5	T10	T20	AT5	AT10	AT20
3.2	13	—	—	—	—	—	—	—	—	—
4.0	—	—	—	6	—	—	—	—	—	—
4.8	20	—	—	—	—	—	—	—	—	—
6.0	—	—	—	10	20	—	—	25	—	—
6.4	27	36	—	—	—	—	—	—	—	—
7.9	—	44	—	—	—	—	—	—	—	—
9.5	—	53	—	—	—	—	—	—	—	—
10.0	—	—	—	20	40	—	—	50	110	—
12.7	—	—	105	—	—	—	—	—	—	—
16.0	—	—	—	—	60	90	—	80	170	250
19.1	—	—	180	—	—	—	—	—	—	—
25.0	—	—	—	—	90	140	—	125	270	400
25.4	—	—	245	—	—	—	—	—	—	—
32.0	—	—	—	—	—	170	340	160	370	500
50.0	—	—	—	—	—	270	540	250	540	800
75.0	—	—	—	—	—	—	800	—	800	1200
100.0	—	—	—	—	—	—	1100	—	1100	1600

7 DESIGN AIDS, DIMENSIONS, TOLERANCES

7.5 ALLOWANCES



Length tolerances

The length tolerances of the optibelt ALPHA TORQUE and ALPHA POWER shown in Table 7.4.3 refer to the drive centre distance. The measuring arrangement is shown in Figure 7.4.1.

Table 7.4.3: Length tolerances ALPHA TORQUE / POWER

T2.5, T5, T10, T20, AT5, AT10		
Timing belt length L_w [mm]		Length tolerance a_{Ltol} [mm]
> 305	≤ 305	± 0.14
> 305	≤ 390	± 0.16
> 390	≤ 525	± 0.18
> 525	≤ 630	± 0.21
> 630	≤ 780	± 0.24
> 780	≤ 990	± 0.28
> 990	≤ 1250	± 0.32
> 1250	≤ 1560	± 0.38
> 1560	≤ 1960	± 0.44
> 1960	≤ 2350	± 0.52
MXL, XL, L		
Timing belt length L_w [mm]		Length tolerance a_{Ltol} [mm]
> 152.4	≤ 254.0	± 0.22
> 254.0	≤ 381.0	± 0.23
> 381.0	≤ 508.0	± 0.26
> 508.0	≤ 762.0	± 0.31
> 762.0	≤ 990.6	± 0.33
> 990.6	≤ 1219.2	± 0.38
> 1219.2	≤ 1524.0	± 0.41
> 1524.0	≤ 1778.0	± 0.43

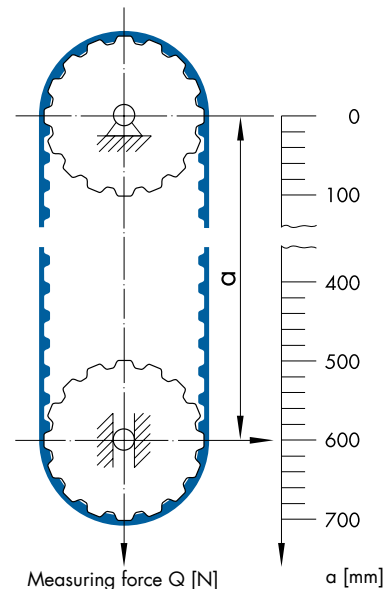

Figure 7.4.1: Arrangement to measure the belt length

The length tolerance for optibelt ALPHA FLEX, ALPHA LINEAR and ALPHA V timing belts consistently amounts to ± 0.5 mm/m. Only ATL profiles basically exhibit a tolerance field shifted towards the negative range, such as e.g. profile ATL10: $-0.3 / -1.1$ mm/m, see also Technical Data Sheets.

Width tolerances

Table 7.4.4: Width tolerances optibelt ALPHA TORQUE and ALPHA POWER

Profile	T2.5	T5, DT5	T10, DT10	T20	AT5	AT10	AT20	MXL	XL	L ¹
To width [mm] or width code	12	25	50	100	25	50	100	025	037	100
Width tolerance [mm]	± 0.3	± 0.5	± 0.5	± 1.0	± 0.5	± 0.5	± 1.0	+0.5 -0.8	+0.5 -0.8	+0.8 -1.3

¹ To belt length 838.2 mm width tolerance ± 0.8 mm

Table 7.4.5: Width tolerances optibelt ALPHA LINEAR / V, ALPHA FLEX

Profile	XL	L, H	XH	T5, T10	T20	AT5, AT10	AT20	5M, 8M	14M
Width tolerance [mm]	± 0.75	± 1.0	± 1.0	± 0.5	± 0.7	± 0.5	± 0.7	± 0.5	± 0.7

The profiles listed here also stand for e.g. ATK profile, ATL profile of the same pitch.

7.5 Allowances

Tables 7.5.1 and 7.5.2 show the allowances to be provided for two-pulley drives with and without flanges in order to install the y and tension x of the timing belt in an unconstrained way. Timing belt pulleys from the standard range are used throughout.

7 DESIGN AIDS, DIMENSIONS, TOLERANCES

7.6 RESISTANCE AGAINST CHEMICAL INFLUENCES



The allowance x provided for tensioning allows the timing belt tension within the permissible elastic elongation, with the assumption that the belt utilises the length tolerance towards a positive value. If the allowance has to be minimised, the load-dependent tension length x_V can be calculated suitable for the drive and the length tolerance can be added in the positive range.

Table 7.5.1: Minimum allowances optibelt ALPHA TORQUE and ALPHA POWER

Minimum allowances	Distance for installation y [mm]				Tension length x [mm]
	Flanges, installation side				
ALPHA TORQUE ALPHA POWER	on both pulleys	on the large pulley	on the small pulley	on no pulley	
MXL	11	9	5	$ a_{Ltol} $ a_{Ltol} from Table 7.4.3	$ a_{Ltol} + 0.0030 \cdot a_{nom}$ a_{Ltol} from Table 7.4.3
T2.5	16	12	7		
T5, AT5, XL	17	13	8		
T10, AT10, L	22	17	10		
T20, AT20	32	25	15		

Table 7.5.2: Minimum allowances optibelt ALPHA FLEX, ALPHA LINEAR, ALPHA V

Minimum allowances	Distance for installation y [mm]				Tension length x [mm]
	Flanges, installation side				
ALPHA FLEX ALPHA LINEAR ALPHA V	on both pulleys	on the large pulley	on the small pulley	on no pulley	
T5, AT5, XL	18	14	9	$0.0005 \cdot a_{nom}$	$0.0035 \cdot a_{nom}$ ALPHA V: $0.0020 \cdot a_{nom}$
T10, AT10, 5M, L, H	25	20	13		
8M	27	22	14		
T20, AT20	38	31	21		
14M, XH	55	44	28		

7.6 Resistance against chemical influences

The data about the resistance against chemical influences only refer to the base material polyurethane and is based on information from the literature, empirical values and laboratory tests e.g. according to DIN ISO 1817 "Elastomers – Determination of the effect of liquids". Cords and polyamide fabric must be considered separately. Therefore, a verification in tests of the selected drive is generally recommended. Simple swelling tests should be performed in advance.

Table 7.6.1: Classification of the resistance against chemical influences, guide values

+	Stable: generally no or only slight weight and dimension changes, no damage through the chemical. No negative impact on the physical values and lifetime.
+/-	Conditionally stable to unstable: noticeable weight and dimension changes with extended exposure; depending on the limiting conditions (e. g. short-term exposure) use partly possible. Negative impact on the physical values and lifetime.
-	Unstable or soluble: strong attack and damage within short time. Quick degradation.

7 DESIGN AIDS, DIMENSIONS, TOLERANCES

7.6 RESISTANCE AGAINST CHEMICAL INFLUENCES



Table 7.6.2: optibelt ALPHA LINEAR / V, ALPHA FLEX: thermoplastic polyurethane

Chemical	Temp. [°C]	Resistance	Chemical	Temp. [°C]	Resistance
Acetone	20	+/-	Copper sulphate, aqueous solution	20	+
Aluminium chloride, 5% aqueous solution	20	+	Methanol	20	-
Formic acid	20	-	Methanol petrol mix 15:85	20	+/-
Ammonia, 10% aqueous solution	20	+	Methylene chloride	20	+/-
Aniline	20	-	Methyl ethyl ketone	20	+/-
Petrol "Normal"	20	+	n-Methyl pyrrolidone	20	-
Petrol "Super"	20	+/-	Mineral oil	80	+
Benzene	20	+/-	Naphta	20	+/-
Borax solution	20	+/-	Sodium carbonate, saturated aqueous solution	20	+/-
Boric acid, aqueous solution	20	+/-	Sodium chloride, saturated aqueous solution	20	+
Butane	20	+	Sodium hydroxide, 1-N aqueous solution	20	+/-
Butanol	20	+/-	Sodium phosphate, aqueous solution	20	+
Butyl acetate	20	-	Sodium soap, 20% aqueous solution	80	+/-
Calcium chlorate (II), 5% aqueous solution	20	-	Sodium soap fat	20	+
Calcium chloride, aqueous solution	20	+	Oleic acid	20	+
Calcium hydrogen sulphite, aqueous solution	20	+	Palmine acid	20	+
Chlorine, gaseous	20	-	Phosphoric acid, 20 to 70% aqueous solution	20	+
Chromic acid, 10 to 50% aqueous solution	20	-	Phosphoric acid, 85% aqueous solution	20	+
Cyclohexane	20	+/-	Mercury	20	+
Cyclohexanol	20	+/-	SAE-10 oil	70	+
Diesel fuel	20	+	Nitric acid, 20% aqueous solution	20	-
Dimethylformamide	20	-	Hydrochloric acid, 20% aqueous solution	20	+/-
Ferric(III)chloride, 5% aqueous solution	40	+/-	Hydrochloric acid, 37% aqueous solution	20	-
Acetic acid, 20% aqueous solution	20	+/-	Grease	20	+
Ethanol	20	+/-	Sulphuric acid, 5% aqueous solution	20	+/-
Ethyl acetate	20	-	Sulphuric acid, 20% aqueous solution	20	+/-
Ethyl ether	20	+	Sulphurous acid	20	-
Formaldehyde, 37% aqueous solution	20	+/-	Sea water	20	+
Freon-11	20	+/-	Soap solution, aqueous	20	+
Freon-113	20	+	Soya oil	20	+
Freon-12	50	+	Stearic acid	20	+
Freon-22	20	+/-	Tannic acid, 10% aqueous solution	20	+
Glycerine	20	+/-	Turpentine	20	-
n heptane	20	+	Carbon tetrachloride	20	+/-
n hexane	50	+	Tetrahydrofurane	20	-
Hydraulic oil	70	+/-	Toluene	20	-
IRM oil 901 (ASTM oil No. 1)	80	+	1,1,1-Trichloroethane	20	-
IRM oil 902 (ASTM oil No. 2)	80	+	Trichloroethene	20	+/-
IRM oil 903 (ASTM oil No. 3)	80	+/-	Tricresylphosphate	20	+/-
Isooctane	20	+	Water	20	+
Isopropanol	20	+/-	Water	90	+
Potassium hydroxide, 1-N aqueous solution	20	+/-	Water	100	-
Kerosene	20	+	Hydrogen	20	+/-
Carbon dioxide	20	+	Extender oil	20	+/-
Copper chloride, aqueous solution	20	+	Xylene	20	-

A verification in tests is recommended.

7 DESIGN AIDS, DIMENSIONS, TOLERANCES

7.6 RESISTANCE AGAINST CHEMICAL INFLUENCES



Table 7.6.3: optibelt ALPHA TORQUE and ALPHA POWER: cast polyurethane

Chemical	Temp. [°C]	Resistance	Chemical	Temp. [°C]	Resistance
Acetone	20	-	Copper sulphate, aqueous solution	20	+
Aluminium chloride, 5% aqueous solution	20	+/-	Methanol	20	-
Formic acid	20	-	Methanol petrol mix 15:85	20	-
Ammonia, 10% aqueous solution	20	+/-	Methylene chloride	20	+/-
Aniline	20	-	Methyl ethyl ketone	20	-
Petrol "Normal"	20	+/-	n-Methyl pyrrolidone	20	-
Petrol "Super"	20	+/-	Mineral oil	80	+/-
Benzene	20	-	Naphta	20	+/-
Borax solution	20	+/-	Sodium carbonate, saturated aqueous solution	20	+/-
Boracic acid, aqueous solution	20	+/-	Sodium chloride, saturated aqueous solution	20	+/-
Butane	20	+	Sodium hydroxide, 1-N aqueous solution	20	+/-
Butanol	20	+/-	Sodium phosphate, aqueous solution	20	+
Butyl acetate	20	-	Sodium soap, 20% aqueous solution	80	-
Calcium chlorate (I), 5% aqueous solution	20	-	Sodium soap fat	20	+/-
Calcium chloride, aqueous solution	20	+	Oleic acid	20	+
Calcium hydrogen sulphite, aqueous solution	20	+	Palmine acid	20	+
Chlorine, gaseous	20	-	Phosphoric acid, 20 to 70% aqueous solution	20	+
Chromic acid, 10 to 50% aqueous solution	20	-	Phosphoric acid, 85% aqueous solution	20	+/-
Cyclohexane	20	+/-	Mercury	20	+
Cyclohexanol	20	+/-	SAE-10 oil	70	+
Diesel fuel	20	+/-	Nitric acid, 20% aqueous solution	20	-
Dimethylformamide	20	-	Hydrochloric acid, 20% aqueous solution	20	+/-
Ferric(III)chloride, 5% aqueous solution	40	+/-	Hydrochloric acid, 37% aqueous solution	20	-
Acetic acid, 20% aqueous solution	20	+/-	Grease	20	+/-
Ethanol	20	+/-	Sulphuric acid, 5% aqueous solution	20	+/-
Ethyl acetate	20	-	Sulphuric acid, 20% aqueous solution	20	-
Ethyl ether	20	+/-	Sulphurous acid	20	-
Formaldehyde, 37% aqueous solution	20	+/-	Sea water	20	+/-
Freon-11	20	+/-	Soap solution, aqueous	20	+
Freon-113	20	+	Soya oil	20	+
Freon-12	50	+	Stearic acid	20	+
Freon-22	20	+/-	Tannic acid, 10% aqueous solution	20	+
Glycerine	20	-	Turpentine	20	-
n heptane	20	+	Carbon tetrachloride	20	+/-
n hexane	50	+	Tetrahydrofurane	20	-
Hydraulic oil	70	+/-	Toluene	20	-
IRM oil 901 (ASTM oil No. 1)	80	+	1,1,1-Trichloroethane	20	-
IRM oil 902 (ASTM oil No. 2)	80	+	Trichloroethene	20	-
IRM oil 903 (ASTM oil No. 3)	80	+/-	Tricresylphosphate	20	+/-
Isooctane	20	+	Water	20	+
Isopropanol	20	+/-	Water	90	+/-
Potassium hydroxide, 1-N aqueous solution	20	+/-	Water	100	-
Kerosene	20	+/-	Hydrogen	20	+/-
Carbon dioxide	20	+	Extender oil	20	+/-
Copper chloride, aqueous solution	20	+	Xylene	20	-

A verification in tests is recommended.

7 DESIGN AIDS, DIMENSIONS, TOLERANCES



7.7 INFLUENCES DURING OPERATION, INSTALLATION AND MAINTENANCE, STORAGE AND TRANSPORT

7.7 Influences during Operation, Installation and Maintenance, Storage and Transport

Correctly designed drives with Optibelt polyurethane timing belts ensure a high operating reliability. Practice shows that unsatisfactory operating times are often attributable to installation and maintenance errors as well as mishandling, storage and transport in addition to unexpected operating and ambient conditions. To prevent this, we recommend observing the following instructions.

Safety instructions for operation

Open and easily accessible drives are to be protected by a protective facility in order to exclude a risk of injury e.g. by reaching into the drive or entangled clothes.

Influences of substances, chemicals and temperatures during operation

Timing belt drives can be destroyed by foreign matter which gets between the belt and pulley. If the effect of foreign matter cannot be excluded, suitable protective devices have to be provided. The same applies to abrasive substances, e.g. dust and/or adhering contamination.

Polyurethane timing belts are resistant to a large number of aggressive chemicals, see Subchapter 7.6 "Resistance against chemical influences". A test under conditions that are as identical as possible with the latest application conditions should be done to verify the relative stability or otherwise of the polyurethane to the tension cord, any coatings or cleats after being subjected to a chemicals or uv radiation. This also applies e.g. to timing belt pulleys and possible existing clamping bushings.

Polyurethane timing belts are basically resistant in a temperature range of $-30\text{ }^{\circ}\text{C}$ to $+80\text{ }^{\circ}\text{C}$. Operating temperatures over $50\text{ }^{\circ}\text{C}$ lead to a decrease of performance in thermoplastic polyurethane. This must be taken into account accordingly. For the operation close to the limits or exceeding the limits, special designs may be required depending on the drive.

In the case of a complete enclosure of the drive, a possible temperature increase inside the enclosure should be taken into account. If required, ventilation should be provided.

Installation of the drive

The installation of the drive comprises the attachment and first alignment of the timing belt pulleys, the fitting of the timing belt, the adjustment of the belt tension and the final verification of the alignment of pulleys and shafts. Idlers and their shafts are not listed here and must, if available, be treated similarly to timing belt pulleys and shafts. If the installation instructions are not observed, early failure and damage to shafts and bearings may be caused. Moreover, the following of the installation instructions is prerequisite for the safety around the drive.

The partly general specified values and the determination of the precise specified values of the respective static belt tensions are indicated in Chapters 3, 4 and 5 for power, linear and transport drives. This also applies to instructions for the application of the suitable Optibelt measuring instrument of the belt tension adjustment.

A more precise description with additional pictures for fastening the timing belt pulleys and about the Optibelt measuring instruments is to be found in the Optibelt documentation "Installation and Maintenance".

Safety note

Prior to the installation and commencement of maintenance it has to be ensured that neither the driving nor the output shaft may start an unintended rotation by stopping the driving machine and fixing the driven machine. In addition, the safety instructions of the machine manufacturer should be followed.

Attaching the timing belt pulleys

Prior to the installation, the respective shaft must be degreased, if clamping bushings are used, and the feather key must be inserted, if required. The screws of the tension elements must be tightened or detached alternately. Finally, for the installation of the drive, the specified tightening torque of the screws of the optibelt TB taper bushings and the optibelt CE clamping bushings must be adjusted with a torque wrench after the alignment of the shafts and pulleys. The tightening torques are found e.g. in the pertaining Optibelt product range or price lists.

7 DESIGN AIDS, DIMENSIONS, TOLERANCES



7.7 INFLUENCES DURING OPERATION, INSTALLATION AND MAINTENANCE, STORAGE AND TRANSPORT

Alignment of pulleys and shafts

The correct alignment of pulleys and shafts ensures a free run of the timing belt between the flanges, reduces the off-track forces and is a prerequisite for a consistent load distribution over all cords and the whole width of the engaging teeth.

The following fault types during alignment should be excluded or minimised and are represented in series in Figures 7.7.1 to 7.7.3.

Axial offset of pulleys:

- The axial offset of timing belt pulleys on parallel shafts must be so low that the overlap of the tooth systems of opposite pulleys corresponds at least with the belt width. During operation, the belt must be fully run on the tooth system in the case of pulleys without flanges.

Parallel arrangement, angular misalignment of shafts:

- The angular misalignment α from shaft parallelism is measured on the level of the shafts.
- The angular misalignment β from shaft parallelism is measured at right angles to the level of the shafts and also referred to as interleaving.

The angular misalignment α should fall below the maximum permissible values in Table 7.7.1, particularly with increasing belt width. This also applies to the angular misalignment β , if the pulleys are close to each other or the pulley diameters selected were large in proportion to the drive centre distance. Interleaved drives with comparatively small pulleys in proportion to the drive centre distance are permitted.

The angular misalignment α can be calculated as follows, if required:

$$\alpha = \arctan \frac{a_z}{a} \quad [^\circ] \quad \text{with } a_z \text{ [mm]}, a \text{ [mm]}$$

For pulleys that have already been aligned in axial direction, for example a_z corresponds to the measured misalignment on the target magnet and a corresponds to the distance between the target magnet and the optibelt LASER POINTER, which here approximately corresponds to the drive centre distance a .

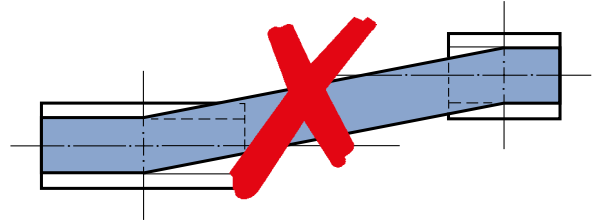

Figure 7.7.1: Axial alignment, type of fault: Offset of pulleys

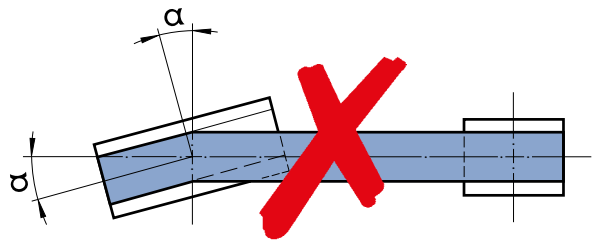

Figure 7.7.2: Parallel alignment, type of fault: Angular misalignment

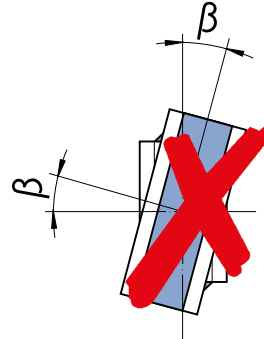

Figure 7.7.3: Parallel alignment, type of fault: Interleaving

Table 7.7.1: Permissible angular misalignment

Timing belt pulley outside \varnothing d_o [mm]	Maximum permissible angular misalignment α, β [°]
≤ 50	0.50
$> 50 \leq 100$	0.25
$> 100 \leq 200$	0.12
> 200	0.06

7 DESIGN AIDS, DIMENSIONS, TOLERANCES



7.7 INFLUENCES DURING OPERATION, INSTALLATION AND MAINTENANCE, STORAGE AND TRANSPORT

If the indicated values are exceeded for the misalignments, a reduced operating time of the timing belts or an early failure has to be expected. In general, with decreasing drive centre distance and increasing width of the belt, the alignment must be more precise.

In a drive freely accessible from one side, the optibelt LASER POINTER facilitates the correct alignment of shafts and pulleys. The optibelt LASER POINTER and at least three target magnets are attached to the front side of the timing belt pulley with a shaft adjustable for tensioning. If the timing belt pulleys are e.g. of aluminium and hence not magnetic, double-sided tape or a sparingly used super glue can be used for the fixing.

Also with a correct alignment of the pulleys, the timing belt exhibits a tendency to run off track at the side. In the case of the endless optibelt ALPHA TORQUE / POWER and ALPHA FLEX timing belts manufactured in a moulding process, this is caused by the helical wounding of the tension cord and the twist of the tensile reinforcement. In contrast, open-ended timing belts optibelt ALPHA LINEAR and endless welded timing belts optibelt ALPHA V exhibit a comparatively lower tendency to run off track due to edge-parallel tensile reinforcements with alternately opposing twist.

Fitting of the timing belt

Prior to the fitting, the drive centre distance should be adjusted in such a way that the timing belt can be slid over the flanges in an unconstrained manner. If no corresponding allowance, e.g. according to Tables 7.5.1 and 7.5.2 was intended, the timing belt must be mounted together with a timing belt pulley in the case of a flange on the installation side or both timing belt pulleys in the case of two flanges on the installation side. A mounting by force is not permitted under any circumstances, since this would often not visibly damage the belt. This can lead to an early failure under load.

Static belt tension

The value of the static belt tension F_T or the elongation L_V can, as mentioned above, be determined and adjusted according to the descriptions in Chapter 3, 4 and 5.

Completion of installation

In addition to the adjustment of the static belt tension, the alignment of the shafts should be checked again, depending on the stability of the machine, and corrected, if necessary.

The screws of the clamping bushings where used must be or must have been tightened to the specified value using the torque wrench.

Finally, the drive cover is installed.

Timing belt sets

Timing belts, which run in pairs or multiples next to each other, e.g. on a parallel conveyor, can be ordered as a set, if required. Then timing belts from the same fabrication sleeve are cut next to each other or, if this is not possible due to the belt width or belt design, withdrawn from one production batch. The lengths are then identical or range between a minimised tolerance field.

Maintenance and inspection

Drives equipped with Optibelt polyurethane timing belts are maintenance-free. Despite this, a regular sight inspection of the timing belt, the timing belt pulleys and e.g. the idlers if used should be conducted. In the case of any uncertainty, possible wear can additionally be determined by measuring the outside diameter of the timing belt pulley. This does not apply to timing belt pulleys with the AT profile. The timing belt pulley outside diameters and tolerances are listed in Subchapter 7.3.

Polyurethane timing belts with stretch-resistant steel tensile reinforcements are maintenance-free and it is hence not necessary to check and adjust them again over the whole service life. This does not apply to timing belts with aramid tensile reinforcement which may exhibit a higher tension loss compared to steel tensile reinforcements.

7 DESIGN AIDS, DIMENSIONS, TOLERANCES



7.7 INFLUENCES DURING OPERATION, INSTALLATION AND MAINTENANCE, STORAGE AND TRANSPORT

Storage and transport

Properly stored polyurethane timing belts will not undergo changes for several years regarding their properties. Unfavourable storage and transport conditions may have a negative effect on polyurethane timing belts. These changes may be caused e.g. through the effect of oxygen, ozone, extreme temperatures, light, moisture or solvents.

This basically also applies to metal items. As these are mostly stored together with the belts, the following instructions can be applied in a simplified way to metal items.

General condition

Polyurethane timing belts should be stored and transported with light and dust protection under dry conditions at room temperature. Also the influence of high ozone concentrations and high moisture should be avoided, if possible. Timing belts must not be stored together with chemicals, solvents, fuels, lubricants, acids, etc.

Temperature

The storage temperature should be between +15 °C and +25 °C. Lower temperatures have generally no damaging effect on timing belts. Since timing belts may become very rigid through cold temperatures, they should be brought to a temperature of approx. +10 °C prior to start-up. This avoids breakages and cracks.

Radiators and their pipes in the vicinity of the stored goods must be shielded. The distance between unshielded radiators and pipes and the stored goods should be at least 1 m.

Light

Belts should be protected against light, particularly against direct sun radiation and strong artificial light with a high ultraviolet portion.

Ozone

To counteract the damaging effect of ozone, the storage rooms should not contain any facilities generating ozone. Combustion gases and vapours which might lead to ozone formation due to photochemical processes, should be avoided or removed.

Moisture

Moist storage rooms are not suitable. Grey cast iron and steel pulleys are not fully protected against rust formation by phosphating. It must be ensured that no condensation occurs. The most favourable relative moisture is below 65 %.

Storage

It must be ensured that timing belts are stored in a stress-free way, i.e. without tension, pressure or other deformation, since this would result in a permanent deformation or the occurrence of cracks.

With the exception of very small lengths timing belt sleeves should be stored in an upright position. Sleeves and individual belts must not be bent to avoid damage on the tensile reinforcements. Sleeves can be placed inside each other. If small sleeves are placed inside each other, it must be ensured that the sleeves are not bent. If the endless sleeves or single belts are stored hanging for space reasons, the diameter of the spindle should correspond to at least 15 times the height of the belt or in the case of an inside tooth system 20 times the coating thickness.

If timing belts in rolls are stored on top of each other in lying condition, they should not exceed a height of 500 mm to prevent permanent deformations.

Extended contact with rubber items may cause marking and should be avoided.

Cleaning

The cleaning of soiled belts can be performed using a cloth and soapy water or spirit 1:1 diluted with water – also undiluted for heavy soiling. Petrol or cold cleaner, for example, should not be used. Furthermore, no sharp-edged items, such as wire brushes or screw drivers may be used, as these may cause mechanical damage to the timing belts. For cleaning metal items, commercially available brake cleaners of a solvent basis should be used.

7 DESIGN AIDS, DIMENSIONS, TOLERANCES

7.8 DAMAGE PATTERNS, CAUSES AND ACTION



7.8 Damage Patterns, Causes and Action

Correctly designed Optibelt polyurethane timing belts achieve long service lives. During a scheduled maintenance or an early failure, the damage, as described in the Tables 7.8.1 to 7.8.3, may present itself on belts, the existing coatings and pulleys. The following tables also comprise the potential causes and recommended action for remedy or correction.

Depending on the damage assessment, the replacement of one or all driving elements is recommended during a maintenance. For example, a new, correctly installed timing belt on worn out pulleys will not achieve a satisfying service life.

Table 7.8.1: Damage on timing belt, causes and action

Damage	Possible causes	Recommended action
Heavy wear on tooth flanks of the belt or tooth base cracks or torn off teeth	<ul style="list-style-type: none"> Incorrect, mostly too low belt tension Belts and pulleys with different profiles Worn out timing belt pulleys Overload, under-dimensioned drive 	<ul style="list-style-type: none"> Correct belt tension according to drive calculation Insert matching belts and pulleys Replace timing belt pulleys Reduce load by design measures, if applicable, re-design drive
Excessive wear in web area of belt	<ul style="list-style-type: none"> Incorrect, mostly too high belt tension Faulty timing belt pulley 	<ul style="list-style-type: none"> Reduce or correct belt tension according to drive calculation Replace timing belt pulley
Extraordinary wear on belt sides	<ul style="list-style-type: none"> Impermissible axial offset of pulleys, non-permitted horizontal and/or vertical angular deviation of shafts Faulty flange Stability of bearing not sufficient Flange distance too low 	<ul style="list-style-type: none"> Re-align shafts and pulleys Replace flange Reinforce bearing or housing Replace timing belt pulleys
Cracks on belt top surface	Ambient temperature insufficient, impact of an unsuitable chemicals	Protect or insulate drive, select different belt type
Swelling of the belt	Influence of incompatible chemicals	Shield drive
Transversal belt cracks	<ul style="list-style-type: none"> Kinked belt or forced installation Impact load Blockade on driving or output side Effect of foreign matter during run Overload or skipping of teeth, under-dimensioned drive Breakage due to permanent kinking Corrosion of tensile reinforcements Skipping of teeth due to insufficient belt tension 	<ul style="list-style-type: none"> Ensure correct storage, transport and installation conditions Reduce impact load, select suitable tensile reinforcement, e.g. aramid Find blockade cause, remove cause or provide sliding clutch Check or install protective device Reduce load by design measures, if applicable, re-design drive Check drive geometry, select suitable tensile reinforcement Influence of chemicals impact, select suitable tensile reinforcements Belt tension according to drive calculation
Longitudinal belt crack	<ul style="list-style-type: none"> Rising of belt onto teeth and flange Crowned idlers 	<ul style="list-style-type: none"> Alignment of pulleys and shafts, check flange design Insert cylindrical idlers

7 DESIGN AIDS, DIMENSIONS, TOLERANCES

7.8 DAMAGE PATTERNS, CAUSES AND ACTION



Table 7.8.2: Damage on the coating, causes and action

Damage	Possible causes	Recommended action
Cracks in the top surface coating	Timing belt pulley diameter too small Ambient temperature insufficient, impact of unsuitable chemicals	Select thinner coating, cut in coating, increase timing belt pulley diameter Shield drive, select different top surface coating
Swelling of top surface coating	Influence of unsuitable chemicals	Shield drive, select different top surface coating
Opening of the joint at the top surface coating	Timing belt pulley diameter too small, tension build-up too high Reversing operation	Increase timing belt pulley diameter, reduce coating strength, inclined or sharpened joint design, no joint Inclined joint design, no joint

Table 7.8.3: Damage on pulley, causes and action

Damage	Possible causes	Recommended action
Separation of flange	Incorrect or unsuitable flange fastening Incorrect alignment of shafts and pulley	Fasten flange correctly Re-align shafts and pulleys
Excessive wear of the timing belt pulley	Influence of unsuitable substances, e.g. corundum dust Unsuitable material Belts and pulleys with different profiles	Check or install enclosure Use pulley with surface treatment or higher material grade Insert matching belts and pulleys

Holder of all copyright and related rights including all rights of use and exploitation: Arntz Optibelt Group, Höxter, Germany. No part of this publication may be used, exploited, reproduced or transmitted to third parties in any form without the prior permission of the Arntz Optibelt Group, Höxter, Germany. Any infringement will be prosecuted under the copyright act law.

The products on offer provided by Optibelt are exclusively oriented towards specialised trade and not towards the consumer. Optibelt recommends that its products are to be exclusively used in accordance with the information provided in Optibelt documentation. The use of Optibelt products in aeroplanes or aviation systems, products and/or applications is not permitted. If in doubt, consult Optibelt before using any Optibelt products. Optibelt does not accept any liability for the use of Optibelt products in systems, products and/or applications for which they were not designed and/or manufactured. This is particularly, but not exclusively, the case if Optibelt products are to be used outside of any specific agreement with Optibelt in circumstances which are unusual or which present a particular risk to health, safety or the environment, or which require a more demanding use.

Errors and omissions excepted. Optibelt does not accept any liability for the correctness or completeness of the information supplied by Optibelt or for the suitability of the information for use by the recipient of the information. Optibelt does not therefore, as far as permitted by law, accept liability for damage resulting outside of any specific agreement with Optibelt from the use of the information or the assumption that the information is correct and complete.

The general terms and conditions of sale of Optibelt GmbH, Höxter, Germany, in particular the agreements relating to retention of title, including in their longer and extended form, shall apply exclusively. These terms and conditions can be obtained free of charge by visiting <http://www.optibelt.de/agb/de>. Optibelt shall not accept any of the customer's own terms and conditions that are contrary to or deviate from these terms and conditions, even if Optibelt does not explicitly object to them or unconditionally renders performance or accepts the performance by the customer irrespective of the customer's conflicting or differing terms of business.

Print: 0616

Optibelt GmbH

Corveyer Allee 15
37671 Hörter
GERMANY

T +49 (0) 52 71- 6 21
F +49 (0) 52 71-97 62 00
E info@optibelt.com



Optibelt Material Handling GmbH

Im Emerten 11
31737 Rinteln
GERMANY

T +49 (0) 57 51-9 67 79-0
F +49 (0) 57 51-9 67 79-10
E info-omh@optibelt.com



www.optibelt.com